



Clarke & Severn Electronics
Ph +612 9482 1944
Email sales@clarke.com.au
www.clarke.com.au

E-BOOK

PCB Fabrication and Material Considerations for the Different Bands of 5G

September 2018

SPONSORED BY



ROGERS
CORPORATION

A large, stylized graphic of the letters "5G" in a dark blue, 3D font. The background is a vibrant, abstract pattern of circuit traces in shades of blue, green, and yellow, creating a sense of depth and movement.

3 Introduction

Pat Hindle
Microwave Journal, Editor

4 5G Update: Standards Emerge, Accelerating 5G Deployment

Pasternack
Irvine, Calif.

10 Making the Most of PCB Materials for 5G Microwave and mmWave Amps

Rogers Corp.

12 Microstrip Defected Ground Structures Without Radiation Loss Using Multilayer PCB Technology

John Coonrod
Rogers Corp., Chandler, Ariz.

16 How to Include the Effects of Circuit Material Copper Surface Roughness in EM Simulations

Rogers Corp.

18 Evaluate PCB PTHs For 5G Application

John Coonrod
Rogers Corporation

Introduction

PCB Fabrication and Material Considerations for the Different Bands of 5G

With initial 5G deployments starting this year for both mobile and fixed wireless access, the race is on to design and manufacture infrastructure to support these deployments. Many of these designs rely on low cost PCBs to attain the cost and manufacturability goals, but the more demanding performance parameters of 5G will push the technology to their limits even with the sub 6 GHz systems.

The higher frequency mmWave systems will require even greater care in the design and selection of PCB materials as these higher frequencies are even more sensitive to PCB effects such as copper surface roughness, Dk variations, thermal dissipation, passive intermodulation, coefficient of thermal expansion, thickness variations and EMC/EMI. PCB designers will have to consider many of these effects in their designs so need to know the various tradeoffs with different types of PCB materials and processes. For higher frequencies, designers typically need to minimize Dk, copper roughness and thickness variations as they can all negatively affect performance. These considerations must be incorporated into the design using accurate models and simulations in order to avoid costly iterations.

This eBook reviews 5G objectives and updates, material selection for the different spectrum of 5G power amplifiers, how to design PCB defected ground structures without radiation loss and how to include the effects of circuit material copper surface roughness in EM Simulations. And for the first time, we are publishing results on the effect of plated through hole surface roughness on high frequency signals as this has never been covered before that we know of in the literature. Some of the higher performance PCB materials use microspheres that increases the surface roughness of plated through holes so this is a key finding to know how they might affect high frequency signals.

Microwave Journal has put together this collection of articles covering these topics in collaboration with Rogers Corporation who has contributed many of the articles in this eBook. Rogers is a leading PCB material manufacturer offering their expertise and experience in this field to educate designers and manufacturers about various PCB material considerations in 5G designs. There are links in this eBook offering advice on various topics in PCB design as Rogers has videos, app notes and other advice available in the [Technology Support Hub](#).

Pat Hindle, Microwave Journal Editor



5G Update: Standards Emerge, Accelerating 5G Deployment

Pasternack
Irvine, Calif.

5G technologies and standards have recently emerged from buzz and corporate blustering to real and rapidly paced definitions and development. When 5G visions were first announced, many considered the performance targets in these predictions to be pipe dreams. However, corporate initiatives to develop 5G technology with real 5G radio and networking platforms and international collaboration on 5G standards has proceeded at a pace few could predict. If this progress means to meet performance targets for 5G, manufacturers must accelerate their timetables and their supply chains to meet the demands of new and competitive 5G hardware and systems.

The race to capture the global business for upcoming 5G solutions—consumer, commercial and government—is starting to resemble the historic space race between Russia and the U.S. The major difference is this goes far beyond a race between two sovereign superpowers, with many international companies and countries in the competition. True 5G solutions require many layers of national and international regulation, as well. Major international telecommunications companies and manufacturers are all competing to demonstrate 5G capabilities and features, while simultaneously paving the way for viable mmWave radio access unit and radio access network (RAN) technology. With spectrum, radio and network standards solidifying ahead of schedule, the pioneering aspects of 5G—mainly the expansion into many more verticals or slices than mobile broadband—are gaining focus and investment.

EARLY 5G FEATURES AND USE CASES

Though the expected features and use cases for 5G are diverse and extensive, the start of the 5G rollout will likely address only a few of the featured use cases: enhanced mobile broadband (eMBB), ultra-reliable

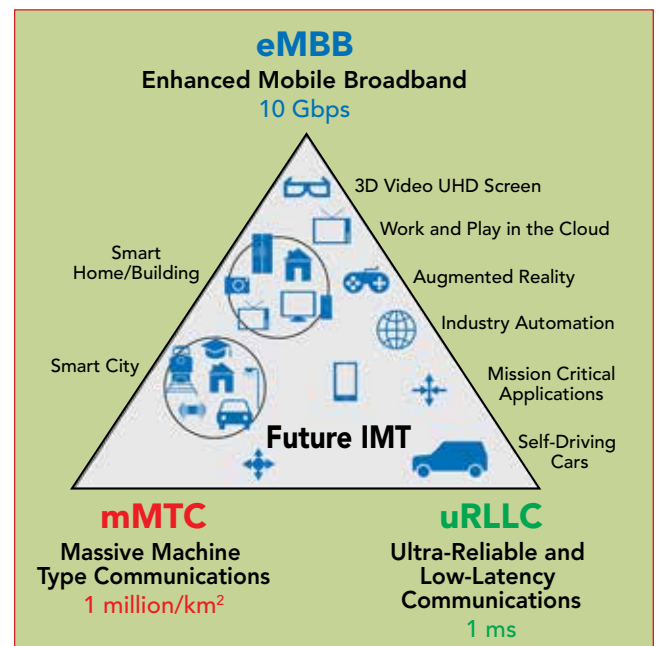

▲ Fig. 1 The primary use cases for 5G. Source: Werner Mohr, The 5G Infrastructure Association.

low latency communications (URLLC) and massive Internet of Things (mIoT) or massive machine-type communications (mMTC), as illustrated in **Figure 1**. These provide increased throughput and performance for user equipment (UE), while offering a mobile network designed to support the massive number of new IoT, or Industry 4.0, applications. Interestingly, these early 5G features will likely be implemented at sub-6 GHz frequencies (current cellular bands, $\leq 1, 3.5$ and 3.7 to 4.2 GHz and various combinations based on country) before 2020, offering opportunities in the vehicle and broadcast market, infrastructure and, primarily, mobile.

EARLY 5G FACTORS AND INFLUENCERS

The main 5G standards bodies and organizations are consistent with past generations of mobile wireless, i.e., 3GPP, GSMA, ITU and each country's spectrum regulatory agency. Importantly, the heads of industry-leading companies are driving these organizations' focus and standards developments. Other industry consortiums and alliances, such as the Next Generation Mobile Networks (NGMN) alliance and TM Forum, are also contributing and advising in the development of 5G standards and specifications.

With the forecast increase in competition for 5G services, and the need to provide lower cost data services now, there is a general impetus to hurry along the advent of 5G. With so many companies and countries taking the initiative with announcements of 5G deployments, these industry and international consortiums have been moving quickly with specifications, standards and spectrum allocation.

Referencing the Verizon 5G Technical Forum (V5GTF), companies feeling the pressure to commercialize more rapidly are even creating new forums to accelerate the development of 5G technologies. Another example of carrier-led efforts to advance 5G is the merger of the xRAN forum and C-RAN Alliance, with the focus of evolving RAN technology from hardware-defined to virtualized and software-driven. Industry forums in market verticals other than mobile are also forming to accelerate adoption and standardization. For example, the 5G Automotive Association encourages collaboration among telecommunication and automotive companies.

Some explanation for this rapid pace could be the concern that collaboration-based organizations have for early adopting companies and countries developing their own regional standards to meet the demand ahead of the competition. For example, some companies, namely AT&T and Verizon, have already claimed they will provide 5G services in select cities in 2018. These 5G services will not necessarily meet all 3GPP 5G specifications, but will likely provide superior throughput to current 4G services and be readily upgraded, most likely through software, to the final 5G specifications. Without 5G capable handsets, either sub-6 GHz or mmWave, it is likely that these companies will offer either hotspot or fixed wireless access (FWA) services instead.¹⁻² While the UE may not yet be available, 5G base station and terminal equipment is; Huawei recently announced 5G end-to-end solutions.³ These offer

sub-3 GHz, C-Band and mmWave operation with massive MIMO technology and are reportedly fully 3GPP 5G compliant. In a demonstration with Telus in Canada, a 5G wireless to the home trial using Huawei equipment reportedly demonstrated 2 Gbps, single-user download speeds.⁴

With a lack of a standardized infrastructure in market verticals other than mobile wireless, however, the standardization and specification for vehicle and industrial applications may take far longer than anticipated. This could explain, somewhat, the additional focus of telecommunication service providers on 5G applications in the broadcast and home internet services markets. FWA using sub-6 GHz and mmWave 5G capabilities could provide gigabit internet speeds to homes without expensive fiber installation and even undercut the cable television and home phone service giants.

5G STANDARDS AND SPECIFICATIONS

The GSMA recently released a report, "Mobile Economy," which claims that two-thirds of the world's mobile connections will be running on 4G and 5G services by 2025, with 4G accounting for over half of the global connections and 5G accounting for approximately 14 percent.⁵ Not surprisingly, the demand has caused standards and specification organizations to step up their timetables, and market pressures are solidifying 5G radio specifications earlier than expected.⁶ However, the "5G precursor" specifications being released now are not the finalized 5G specifications and standards, rather evolutionary steps from 4G specifications that will be compatible with the future 5G specifications.

The latest 3GPP specification defines the non-stand-alone 5G new radio (NSA 5G NR),⁷ which requires an LTE anchor and 5G NR cell. The LTE anchor provides the control plane and control plane communications, while the 5G NR will provide enhanced data capacity. The NSA 5G NR specification currently only covers frequency range 1 (FR1), between 450 and 6000 MHz. These bands are designated in Table 5.2-1 in the 3GPP specification document 38101-1,⁸ and are subject to modification when Release 15 is issued in June 2018. The maximum bandwidth for FR1 NR bands is 100 MHz, of which only n41, n50, n77, n78 and n79 are capable. These bands are also designated as time-division duplex (TDD) bands, for which carrier aggregation (CA) should enable greater than 100 MHz functional bandwidth.

Also in this release are the descriptions of new RAN architecture options. The new architecture is built around a network virtualization strategy, where the control and user planes are separated. Referred to as network function virtualization (NFV) and software-defined networking (SDN), these features are designed to enable future network flexibility and a variety of applications. This methodology is meant to continue providing enhanced mobile telecommunications, while adding diversity of services—hence, independent network slicing.⁹

Future 5G "Cloud RAN" capabilities (see **Figure 2**) are meant to support multiple RANs, standards and operators using the same physical infrastructure or core

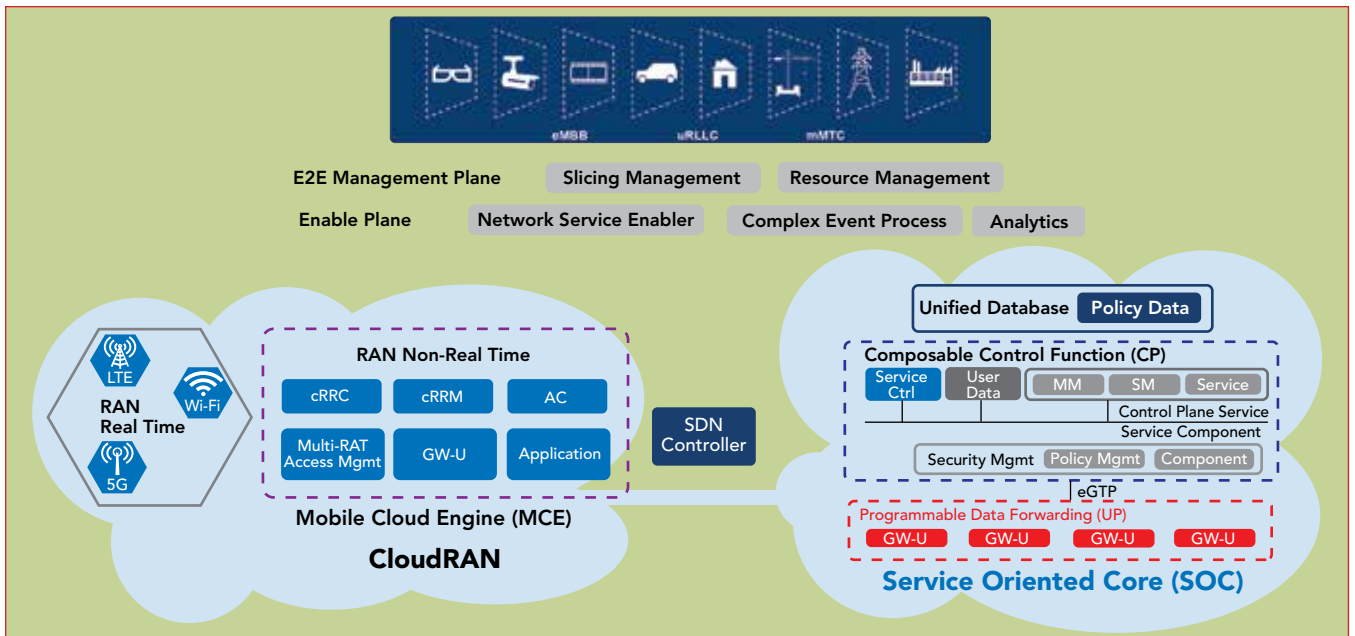

▲ Fig. 2 A new virtualized cloud radio access network architecture will enable operators to serve the multiple use cases envisioned for 5G. Source: Huawei.

network. Such an adaptable RAN would allow for various applications and industries to rely on the same hardware and network assets, physical infrastructure to pave the way for future opportunities. The system to provide capabilities for service-level agreements for a collection of devices is dubbed “network slicing” by 3GPP.

The future 5G standard, what will be concluded in the complete 3GPP Release 15, or 5G Phase 1, will be finalized in June 2018 (see **Figure 3**). Before the end of 2019, 3GPP will provide updates to Release 15, and a clearer vision of Release 16, or 5G Phase 2, will become available in December 2019. Currently, there is little information on how 5G rollouts will occur and what industries, outside of mobile wireless, will begin adopting the capabilities of 5G. Though trials have been performed

and early 5G network and radio access hardware is available, UEs have yet to be released, and operators have virtually no experience and limited understanding or expectations of 5G. Furthermore, mmWave hardware is not yet widely available and, without this valuable experience, solidifying 5G mmWave specifications is impractical. The mmWave frequency designations for 5G will not be identified for the ITU until WRC-2019, in time for IMT-2020.

5G Phase 1 is still based on OFDM waveforms, though there are a variety of candidate waveforms which may eventually supersede OFDM. Specifically, 5G phase 1 leverages cyclic prefix OFDM (CP-OFDM) for the downlink, and both CP-OFDM and discrete Fourier transform spread OFDM-based (DFT-S-OFDM) waveforms for the

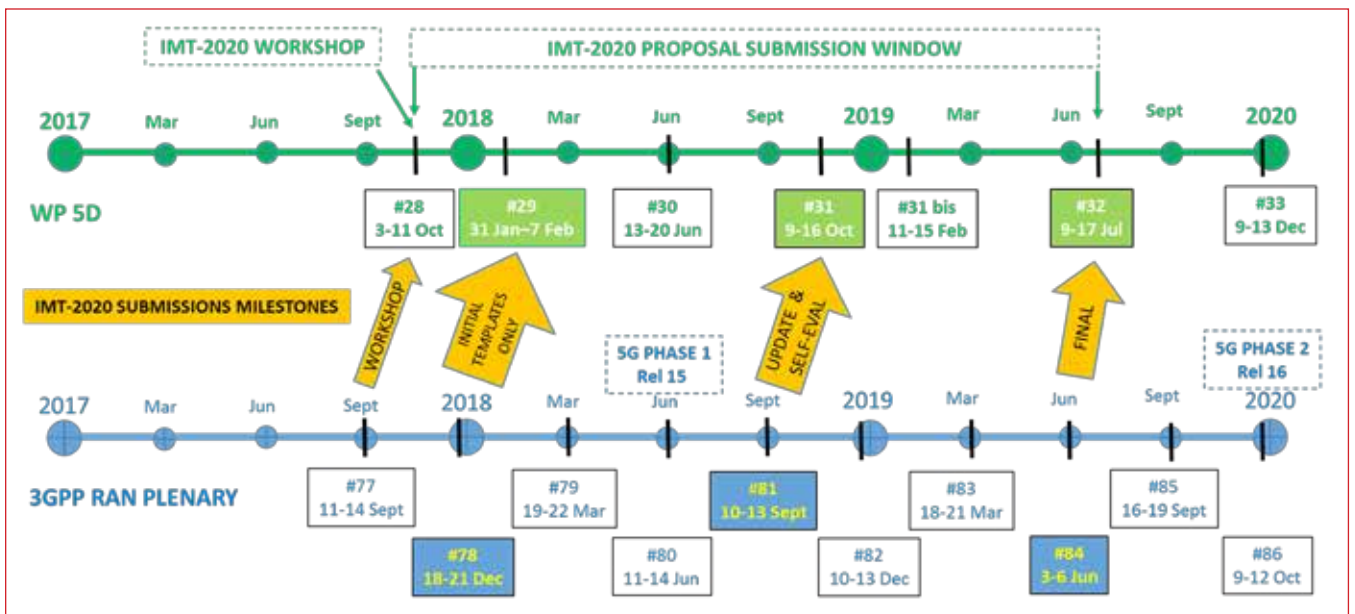

▲ Fig. 3 3GPP timeline for 5G specifications. Source: 3GPP.

uplink. 5G Phase 1 allows for flexible subcarrier spacing, where the subcarriers can be spaced at $15 \text{ kHz} \times 2^n$ to a maximum of 240 kHz with a 400 MHz carrier bandwidth. Up to two uplink and four downlink carriers can be used, for a combined uplink bandwidth of 200 MHz and downlink bandwidth of 400 MHz.

CURRENT 5G HARDWARE

For the past few years, many telcos and hardware/platform manufacturers have been engaging in a game of 5G one-upmanship. Early demonstrations included mmWave throughput, mMIMO, CA and a variety of software and hardware examples. Many of the latest 5G trials and demonstrations involved technology more aligned with the upcoming 3GPP Release 15, capable of being updated by software to meet the final 5G Phase 1 specification and future updates.

Hence, many of the recently released and announced 5G modems and transceivers are able to be updated via software, and offer throughput handling capabilities that account for greater bandwidth availability at currently unavailable mmWave frequencies. Many leading hardware manufacturers and telecommunication companies are continuing to push to advance 5G trials and deployments by 2019, well ahead of a final specification, by leveraging NSA 5G NR and technology that can be modified to meet the finalized specifications.¹⁰ Given the nature of the race to commercialize 5G, and the likelihood of future 5G specifications adjusting to the findings of early trials and deployments, programmability and flexibility of both the software and hardware of 5G radios and core networks are essential.

Another factor to consider with 5G hardware is not only backward compatibility, but dual connectivity of 4G LTE and 5G systems. Similar to how prior generations of mobile wireless were eventually integrated into the latest specifications, it is likely that current 4G LTE rollouts will be merged into future 5G specifications. Supporting dual connectivity, backward compatibility and future 5G specifications will require highly adaptable RF hardware that can allocate resources based on the actual environment, not just preprogrammed scenarios.¹¹⁻¹²

As the finalized 5G mmWave spectrum and radio hardware is not yet determined, and extensive mobility trials with mmWave frequencies are still underway, the first round of 5G mmWave technology will provide fixed wireless service (FWA). This approach minimizes many of the challenges associated with a complete 5G solution, including mmWave mobility concerns around non-line-of-sight and antenna beam tracking with moving UEs. Also, FWA 5G modems and transceiver chips can be larger, use more power and cost more than modem and transceiver chips for UE.

Available 5G modems, typically with integrated 5G transceivers, are offered by Samsung, Qualcomm, Intel, Huawei and others. Some of these early 5G chipsets are reportedly capable of 2 Gbps data rates and mmWave transceiver operation at 28 GHz. Common features include NSA 5G NR compatibility, with a variety of beamforming techniques, antenna switching, 3D frequency

planning tools and virtualized RAN.¹³⁻¹⁴

Currently, device and network hardware manufacturers, with associated telecommunications service providers and test and measurement manufacturers, are engaging in 5G NR trials with simulated UEs. Samsung and National Instruments, as well as Datang Mobile and Keysight Technologies, demonstrated what will likely be commercial 5G base station hardware and 5G UE emulation systems at Mobile World Congress 2018.¹⁵⁻¹⁶ It is likely that 5G UE chipsets will become available in 2019, although it is unknown if these UE will leverage mmWave technology or just the sub-6 GHz 5G FR1 frequencies.

The latest commercially available 5G hardware solutions are typically RF front-end (RFFE) modules designed to account for the new NSA 5G NR frequencies, which can be included with other RFFE hardware to offer a complete solution. These RFFEs include power amplifiers (PA), low noise amplifiers (LNA), switches and filters and differ somewhat from 4G RFFEs. As the power Class 2 specification for higher output power (26 dBm at the antenna) is available for 5G hardware, PAs may be higher power than with 4G, necessary to overcome increased propagation losses at higher frequencies through the atmosphere and common building materials.

With 100 MHz of available Tx bandwidth, techniques like envelope tracking—which currently only supports up to 40 MHz of bandwidth—may not be viable; less efficient techniques, such as average power tracking are more likely for early 5G systems. These early 5G RFFE modules will likely be wideband, requiring additional filtering for the new sub-6 GHz 5G bands, as well as the legacy and still necessary 4G bands. These multi-band filters are currently more complex combinations of surface acoustic wave (SAW), bulk acoustic wave (BAW) and film bulk acoustic wave (FBAR) filter banks and integrated modules.

RF HARDWARE AND TEST SYSTEMS

Given the inclusion of new sub-6 GHz frequency bands in NSA 5G NR, new RF hardware is needed to support these new frequencies—specifically n77, n78 and n79—which were not previously used for mobile wireless. Though not determined in NSA 5G NR, frequency bands below 600 MHz may eventually be supported by 5G for massive low power connectivity such as IoT, Industry 4.0/Industrial IoT and other machine-type communications. The additional subcarrier channel spacing, bandwidth, CA and 4 x 4 MIMO specifications result in the need for large numbers of filters, antennas, LNAs, PAs and switches, with accompanying NSA 5G NR modems and RF transceivers.

The early 5G modems and transceivers do not necessarily need to contend with these challenges, as these commercial devices can operate on select bands. However, 5G base stations for eMBB and future industrial and vehicle applications will require forward and backward compatibility. This means that 5G RF hardware will need to service all current mobile frequency bands, as well as 5G FR1 and 5G mmWave FR2 fre-

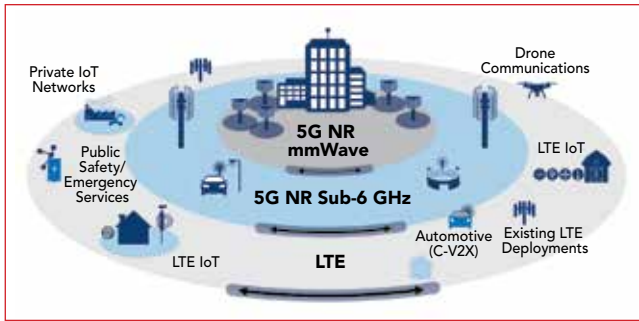

▲ Fig. 4 Once deployed, standalone 5G services, operating at sub-6 GHz and mmWave frequencies, will need to coexist with LTE. Source: AndroidAuthority.com; used with permission.

quencies (see **Figure 4**). This is a particularly troublesome hardware challenge, as the hardware for many of the existing cellular frequencies may interfere with the NSA 5G NR bands, as dual connectivity is necessary to meet the throughput specifications. Also, the new NSA 5G NR frequency bands surround the ISM bands for Wi-Fi, Bluetooth and other wireless equipment operating in the unlicensed bands.

With such closely packed bands and extremely wide-band radios, the performance degradation from receiver desensitization is likely with inadequate filtering, PA linearity and harmonic suppression. New NSA 5G NR transmitters can operate with higher output power and higher peak-to-average power ratios for maximum throughput, which may cause problems with co-located 5G receivers in the same base station or nearby 5G devices.

Real estate for RF hardware, especially antennas, is already small in UEs, and 5G specifications may require 4 x 4 MIMO for the downlink and 2 x 2 MIMO for the uplink, meaning six independent RF pathways. 5G antenna tuning technologies will be critical to maximize antenna radiation efficiency over wide bandwidths. These RF pathways must also be much wider than 4G LTE pathways, as NSA 5G NR now supports 100 MHz bandwidth on a single carrier, with more CA options (up to 600 new combinations with Release 15). NSA 5G NR also allows for 200 MHz combined uplink and 400 MHz combined downlink bandwidth. This results in a

substantial amount of data to process, challenging for energy efficient UEs and base stations.

It is probable that the RF hardware for UEs will be increasingly integrated, with filter banks, high density switches, antenna tuning, LNAs and PAs integrated into RFFE with systems on chip (SoC) technologies. 5G UE antennas may also be integrated solutions, possibly with antenna tuning and some pre-filtering and beamforming features included. This level of integration is also plausible to achieve the cost targets to ensure handsets are affordable and meet phone form factors.¹⁷⁻¹⁹ With the increased complexity of 5G and the need for dense RF solutions, it is no surprise that many UE manufacturers are attracted to 5G modem-to-antenna solutions for faster development and deployment.

Many current 4G UEs and base stations rely on LD-MOS, GaAs and SiGe PAs, with GaN a recent entry into the base station PA market. As the frequency is extended to sub-6 GHz, LDMOS, which struggle beyond 3 GHz, is less likely to meet 5G specifications, while GaN PAs—and possibly LNAs—are likely to be used in the infrastructure. GaAs and SiGe amplifiers will compete for amplifier and switching functions in the sub-6 GHz 5G applications. To maintain lower cost and smaller form factors than current mmWave PA, LNA and switch solutions provide, highly integrated RF silicon on insulator (SOI) technologies are likely to be used for 5G mmWave applications. Future RFFEs may use RF SOI, SiGe BiCMOS or RF CMOS SoCs that integrate the PA, LNA, switches and control functions to operate mmWave phased array beamforming antenna systems (see **Figure 5**). It is possible that future RF silicon technologies can be further integrated or combined with other technologies to include filtering and the digital hardware required to enable hybrid beamforming modules. Future variations of RF SOI or RF CMOS may even be integrated with more advanced digital hardware, such as FPGAs, memory and processors. Baseband processing and accessory DSP functions could be implemented in the package, as well, for compact 5G mmWave solutions.

As frequency routing and filtering is essential for 5G CA and back compatibility with prior mobile generations, integrated SAW, BAW, FBAR and other integrated reso-

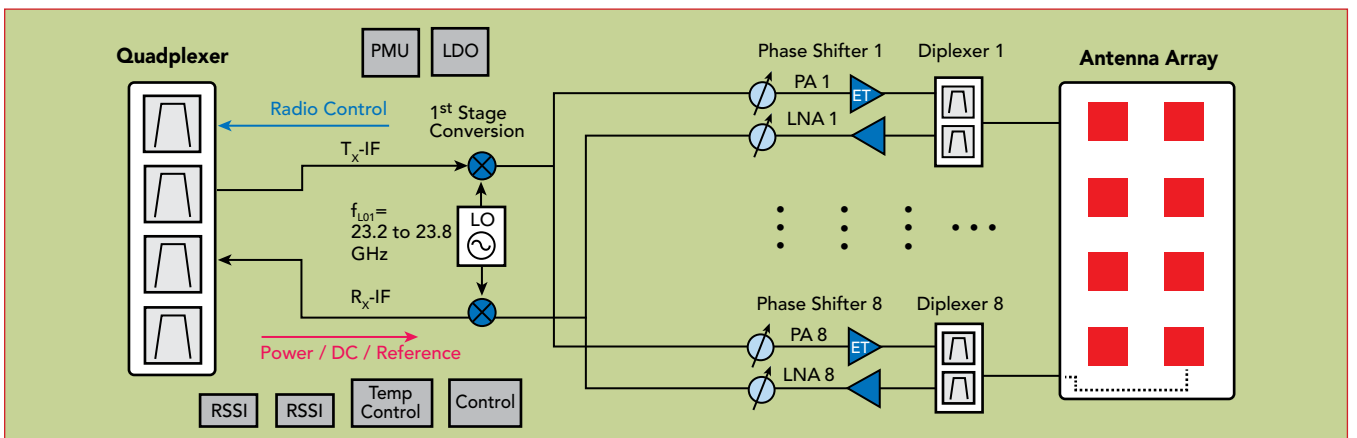

▲ Fig. 5 5G FDD beamforming module architecture. Source: arXiv:1704.02540v3 [cs.IT].

nators and filter technologies are essential for UEs and even compact small cells. With the potential for interference and design complexity, 5G modules for UEs will also likely incorporate Wi-Fi and Bluetooth modules, further increasing the filtering and frequency routing complexity. Other integration-capable technologies, such as RF SOI, may be employed for 5G RFFEs, as recent advances in RF SOI enable filter and amplifier co-integration. It may be several years before SOI filters are used for sub-6 GHz 5G applications, although it may be sooner for mmWave systems, as amplifier and switch integration possible with SOI technologies make this an attractive next step.

CONCLUSION

The rapid progression of 5G specifications and the rush of mobile wireless manufacturers and service providers to start 5G trials and deployments has led to a plethora of early 5G demonstrations and interim 5G specifications. In just the past few months, modem, transceiver and RF hardware manufacturers have been announcing 3GPP-compliant 5G solutions, which rely on heavy integration and software reprogrammability to meet current demand and provide future-proofing. This deep level of integration and soon-to-come 5G deployments will require flexible test and measurement systems which can be readily adapted to the changing standards and lessons learned from early trials.²⁰ Access to 5G accessories and interconnect technologies, especially 28 GHz and other mmWave components and devices, will be essential to prevent delays in trials and deployments. ■

References

1. S. Segan, "What is 5G," *PCMag*, March 2018, www.pcmag.com/article/345387/what-is-5g.
2. "Paving the Way for Wireless Internet TV to the Home," *RCR Wireless News and Anritsu*, February 2018, www.rcrwireless.com/20180222/5g/paving-way-wireless-internet-tv-home.
3. "Huawei Launches Full Range of 5G End-to-End Product Solutions," *Huawei*, February 2018, www.huawei.com/en/press-events/news/2018/2/Huawei-Launches-Full-Range-of-5G-End-to-End-Product-Solutions.
4. J. P. Tomás, "Huawei, Telus Launch 5G Fixed Wireless Trial in Canada," *RCR Wireless News*, February 2018, www.rcrwireless.com/20180215/5g/huawei-telus-5g-fixed-wireless-tag23.
5. "Two-Thirds of Mobile Connections Running on 4G/5G Networks by 2025, Finds New GSMA Study," *GSMA*, February 2018, www.gsma.com/newsroom/press-release/two-thirds-mobile-connections-running-4g-5g-networks-2025-finds-new-gsma-study/.
6. "Video — NR First Specs & 5G System Progress," *3GPP*, January 2018, www.3gpp.org/news-events/3gpp-news/1934-nr_verticals.
7. "3GPP Specification Series," *3GPP*, www.3gpp.org/DynaReport/38-series.htm.
8. "Specification #: 38.101-1," *3GPP*, <https://portal.3gpp.org/desktopmodules/Specifications/SpecificationDetails.aspx?specificationId=3283>.
9. "Video Interview — On 5G Core Stage 3 Work," *3GPP*, January 2018, www.3gpp.org/news-events/3gpp-news/1940-ct_5g.
10. "Global Mobile Industry Leaders Commit to Accelerate 5G NR for Large-Scale Trials and Deployments," *Qualcomm*, February 2017, www.qualcomm.com/news/releases/2017/02/25/global-mobile-industry-leaders-commit-accelerate-5g-nr-large-scale-trials.
11. B. Thomas, "Is Your Handset RF Ready for 5G?," *Qorvo*, February 2018, www.qorvo.com/resources/d/is-your-handset-ready-for-5g-qorvo-white-paper.
12. "Making 5G NR a Commercial Reality; A Unified, More Capable 5G Interface," *Qualcomm*, December 2017, www.qualcomm.com/documents/accelerating-5g-new-radio-nr-enhanced-mobile-broadband-and-beyond.
13. "Samsung Unveils the World's First 5G FWA Commercial Solutions at MWC 2018," *Samsung*, February 2018, <https://news.samsung.com/global/samsung-unveils-the-worlds-first-5g-fwa-commercial-solutions-at-mwc-2018>.
14. "Intel Introduces Portfolio of Commercial 5G New Radio Modems, Extends LTE Roadmap with Intel XMM 7660 Modem," *Intel*, November 2017, <https://newsroom.intel.com/news/intel-introduces-portfolio-new-commercial-5g-new-radio-modem-family/>.
15. "NI and Samsung Collaborate on 5G New Radio Interoperability Device Testing for 28 GHz," *National Instruments*, February 2018, www.ni.com/newsroom/release/ni-and-samsung-collaborate-on-5g-new-radio-interoperability-device-testing-for-28-ghz/en/.
16. "Keysight Technologies, DatangMobile Demonstrate 5G-New Radio Solutions at Mobile World Congress 2018," *Keysight Technologies*, February 2018, <https://about.keysight.com/en/newsroom/pr/2018/27feb-nr18025.shtml>.
17. Y. Huo, X. Dong and W. Xu, "5G Cellular User Equipment: From Theory to Practical Hardware Design," *IEEE Access*, Vol. 5, July 2017, pp. 13992-14010.
18. "Qorvo® and National Instruments Demonstrate First 5G RF Front-End Module," *Qorvo*, February 2018, www.qorvo.com/newsroom/news/2018/qorvo-and-national-instruments-demonstrate-first-5g-rf-front-end-module.
19. P. Moorhead, "Qualcomm Raises Wireless Stakes With Full 5G Modules and More RF Offerings," *Forbes*, February 2018, www.forbes.com/sites/patrickmoorhead/2018/02/27/qualcomm-raises-wireless-stakes-with-full-5g-modules-and-more-rf-offerings/#d192567ae9f2.
20. "Frost & Sullivan Spots Five Areas in Radio Frequency Test & Measurement that Will Create Over \$30 Billion in New Revenues by 2023," *Frost & Sullivan*, February 2018, www2.frost.com/news/press-releases/frost-sullivan-spots-five-areas-radio-frequency-test-measurement-will-create-over-30-billion-new-revenues-2023/.

Making the Most of PCB Materials for 5G Microwave and mmWave Amps

The ROG Blog is contributed by John Coonrod and various other experts from Rogers Corporation, providing technical advice and information about RF/microwave materials.

Rogers Corp.

Millions of cell phones trying to connect voices and download unimaginable numbers of files worldwide point to the inevitability of Fifth Generation (5G) wireless communications networks. 5G is coming, and it will require the right circuit materials for many different types of high-frequency circuits, including power amplifiers (PAs). 5G may represent the latest and greatest in wireless technology, but it will be challenging to design and fabricate, starting with the circuit-board materials, because it will operate across many different frequencies, such as 6 GHz and below as well as at millimeter-wave frequencies (typically 30 GHz and above); it will also combine network access from terrestrial base stations and orbiting satellites. But by careful consideration of mechanical and electrical requirements, high-frequency circuit materials can be specified that enable the design and development of 5G PAs no matter the frequency.

Ideally, a single circuit material would be a suitable starting point for PAs at all frequencies. However, amplifiers at different frequencies have different design requirements and are best supported by circuit materials with different characteristics best suited to the different frequencies. For example, insertion loss or dissipation factor can be more or less depending on the type of circuit material. Every circuit material will suffer some amount of loss, and the loss typically increases with increasing frequency. The loss performance of a given circuit material may be acceptable within the microwave frequencies to be used in 5G networks but not within the millimeter-wave frequency range, where signal power tends to be less with increasing frequencies. The circuit material that provides the low loss needed for high PA gain and output power at microwave frequencies may

not be the best choice of material for a PA at millimeter-wave frequencies.

Design requirements for a key circuit material parameter, dielectric constant (Dk), are much different at microwave frequencies, such as the 6 GHz and below of 5G systems, than they are at millimeter-wave frequencies, such as 30 GHz and above, as will be used for short-range backhaul links in 5G wireless networks. Part of finding an optimum circuit material for each band of frequencies requires understanding which Dk value best supports each of the two different frequency ranges. Then it is a matter of finding circuit materials that possess those Dk values along with as many as possible of the other circuit material attributes that help make a good, high-performance, high-frequency PA.

Whether for microwave or millimeter-wave frequencies, circuit materials for high-frequency PAs must be capable of supporting circuitry that achieves the impedance match to the power transistors in those PAs. Such impedance matching is also necessary for the active devices in lower-power amplifiers, such as driver amplifiers and even in low-noise amplifiers (LNAs). Suitable circuit materials for such impedance matching networks must be capable of keeping circuit impedance variations to a minimum, and this is typically done through tight control of the substrate thickness (no variations in thickness); tight control of conductor widths, such as microstrip transmission lines, to maintain the same impedance; tight control of the copper thickness on circuit laminates; and tight control of the circuit material's Dk, especially with temperature. Although using a circuit material with tight control of Dk, such as 3.50 ± 0.05 , can help maintain the impedance of high-frequency transmission lines within a narrow window as might be

needed for impedance matching within a PA circuitry, variations in the substrate thickness can have even more impact on maintaining consistent impedance of high-frequency transmission lines. A circuit material with a Dk tolerance of ± 0.05 or lower is considered as having a tightly controlled Dk value.

With increasing frequencies, signal wavelengths are decreasing, requiring ever-smaller circuit features. Many of the PA circuit configurations used at both microwave and millimeter-wave frequencies, such as Doherty amplifiers, are dependent upon quarter-wavelength transmission-line circuit structures and the dimensions of these structures are a function of the substrate thickness. If that circuit substrate thickness is not tightly controlled, it is easy to understand how the impedance of extremely fine transmission-line and circuit structures can vary with those variations in substrate thickness. In general, a substrate thickness variation of $\pm 10\%$ or better is a sign of tightly controlled circuit material thickness.

FEELING THE HEAT

Whether at microwave or at millimeter-wave frequencies, PA circuits are subject to performance variations brought about by changes in temperature, from both the operating environment and from the PA's own active devices, such as power transistors or ICs. In the search for circuit materials for both microwave and millimeter-wave PAs for 5G applications, finding circuit materials capable of effective thermal management is critical to minimizing a PA's performance variations as a result of the thermal rise brought about by its own active devices. Two circuit material parameters are of particular interest when assessing a material's thermal behavior: thermal conductivity and thermal coefficient of dielectric constant (TCDk).

High thermal conductivity allows for efficient flow of heat away from any heat-generating active devices mounted on a PCB, such as a PA's power transistors. Consistent heat flow not only removes the heat as a threat to the reliability of the transistors, but helps minimize thermally induced PA performance variations. Thermal conductivity of 0.5 W/m·K or higher is considered good for a PCB material.

TCDK is a circuit material parameter that indicates how that material's Dk is affected by variations in temperature. Ideally, a material would have a TCDk of 0 ppm/ $^{\circ}\text{C}$ for no change in Dk with temperature. But practical circuit materials exhibit some changes in Dk

with temperature and a TCDk of $|\text{Dk}|$ ppm/ $^{\circ}\text{C}$ is considered good for a circuit material, resulting in only small changes in Dk with temperature. For the amplifiers and other circuits in 5G systems that will rely on fine quarter-wavelength circuit structures, circuit materials with low TCDk values will help minimize performance variations.

The smaller wavelengths and circuit features needed for millimeter-wave PAs and circuits in general will require thinner substrate materials compared to lower-frequency microwave PAs and circuits, and maintaining a tight tolerance in that thickness is just as critical as for thicker materials. Those thinner circuit materials can also be more sensitive than thicker circuit materials to the effects of other circuit material characteristics, such as copper surface roughness. Copper surface roughness can result in such circuit effects as transmission-line loss and phase variations, so copper surface roughness should be minimized in any circuit materials specified for the smaller-wavelength, higher-frequency circuits in both 5G microwave and millimeter-wave PAs.

As examples of circuit materials that provide the desirable characteristics for 5G amplifiers, Rogers Corp. (www.rogerscorp.com) offers materials with different thicknesses and other characteristics as needed for the two different frequency ranges. For example, for 5G PAs at 6 GHz and below, 20- and 30-mil-thick ceramicbased RO4385™ circuit laminates are low-cost circuit materials that maintain consistent performance across wide temperature ranges. They have Dk of 3.48 in the z-axis (thickness) at 10 GHz, tightly controlled within ± 0.05 . They are ideal for competitive applications and can be fabricated with standard epoxy/glass (FR-4) processes.

For 5G PAs at millimeter-wave frequencies, 5- and 10-mil-thick RO3003™ laminates consist of PTFE with ceramic filler. They feature Dk of 3.0 in the z-axis at 10 GHz tightly controlled within ± 0.04 . They feature the extremely low loss at higher frequencies that helps get the most gain from the active devices in an amplifier circuit, even at the various millimeter-wave bands expected to serve the many backhaul links of future 5G wireless networks.

Do you have a design or fabrication question? Rogers Corporation's experts are available to help. Log in to the Rogers Technology Support Hub and "[Ask an Engineer](#)" today.

Microstrip Defected Ground Structures Without Radiation Loss Using Multilayer PCB Technology

John Coonrod
Rogers Corp., Chandler, Ariz.

A multilayer circuit design using defected ground structures is used to enhance filter performance without concern for leakage and isolation.

Microstrip defected ground structures (DGS) have been a part of high frequency circuit design for many years and are also used with stripline and coplanar waveguide circuits.¹⁻³ While DGS circuit design approaches can provide benefits in the performance and miniaturization of resonator-based RF/microwave components, such as antennas and filters, the technology is limited by serious drawbacks, including low isolation and excess electromagnetic (EM) radiation. DGS-based circuits can radiate EM energy, resulting in electromagnetic interference. Lack of isolation can also result in undesirable interaction with neighboring RF/microwave components and circuits. Fortunately, because of the increasing use of multilayer circuit configurations in modern RF/microwave circuit designs, it is possible to design and fabricate microstrip DGS circuits with little or no concern for radiation or isolation. This multilayer approach is demonstrated with a lowpass filter (LPF) design and some readily available commercial circuit materials.

DGS OVERVIEW

Perhaps the easiest way to understand a DGS is to consider a ground plane as a continuous structure, with no breaks or interruptions. The electrical characteristics of a transmission line, such as microstrip, assumes this ground plane continuity. By purposely forming a defect, such as an isolated opening etched in the ground plane, the transmission line's RF characteristics are altered. Capacitance and inductance can change significantly in the area of the DGS.

A simple example is an H-shaped feature etched in the ground plane of a microstrip transmission line (see

Figure 1). The microstrip structure shown in Figure 1a has two copper layers. The dark orange color repre-

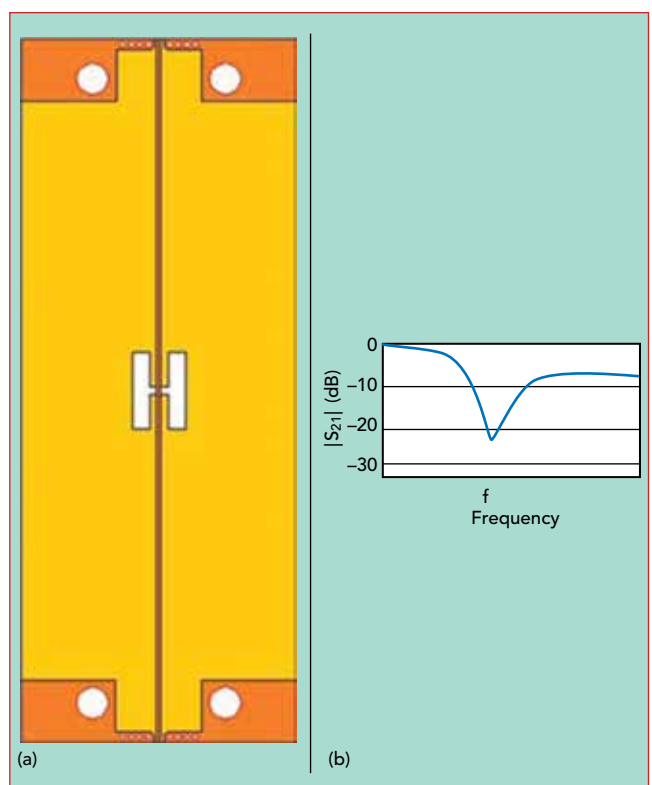
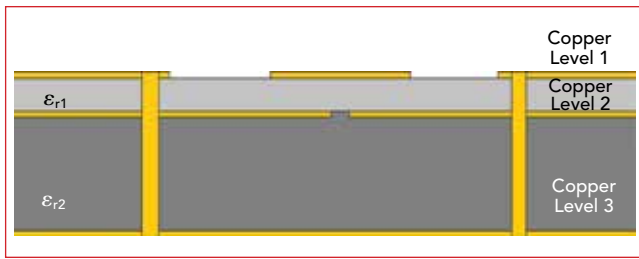

Fig. 1 Top view of a microstrip transmission line with an H-shaped DGS etched in its ground plane (a) and $|S_{21}|$ for this structure (b).



▲ Fig. 2 Cross-section of a PCB with three copper layers used to realize a microstrip DGS without radiation and isolation concerns.

sents circuit features on the top copper layer (the signal layer), and the light orange color depicts circuit features on the bottom copper layer (the ground plane). The H-shaped DGS produces a bandstop or band-reject characteristic, as shown in Figure 1b. The response is similar to a one-pole Butterworth lowpass filter (LPF). The DGS pattern can be altered to generate a very narrowband bandstop response, which is sometimes added to a filter design to improve isolation in the stopband portion of the filter. As will be shown with a practical LPF design, the effective use of a microstrip DGS not only improves a filter's stopband response but greatly improves a filter's spurious harmonic responses.

A DGS can enhance the performance of many RF/microwave components, including LPFs, bandpass filters (BPF), patch antennas and other resonant circuits. A search of the IEEE Xplore® Digital Library yields many white papers where a DGS is used in these applications. DGS structures can also be used to reduce circuit size, with the ability to implement slow-wave effects.

OVERCOMING DGS RADIATION AND ISOLATION

With the growing complexity and integration found in modern RF/microwave circuits, multilayer circuit construction is often employed. Proper design of a multilayer printed circuit board (PCB) circuit containing a microstrip DGS can minimize or even eliminate EM radiation and isolation. Multilayer PCBs can be constructed in many shapes and sizes.

For the sake of simplicity, a multilayer PCB with three copper layers is used as an example to demonstrate a method for minimizing DGS radiation and isolation (see **Figure 2**). The figure shows a multilayer PCB with two different substrate materials having dielectric constants ϵ_{r1} and ϵ_{r2} . For an ideal DGS, the dielectric constant of the lower substrate material, ϵ_{r2} , is a value equivalent to that of air, i.e. $\epsilon_{r2} = 1.0$. It is possible to embed an air cavity within a multilayer PCB, but it is difficult and typically expensive to fabricate. A compromise is to use a substrate with a low value of ϵ_{r2} that is robust enough to tolerate PCB manufacturing processes. The benefits of using substrate materials with different ϵ_r values are explained later in this article.^{4,5}

The top two copper layers are microstrip and its defected ground plane. They may appear as grounded coplanar waveguide transmission lines, but they are actually loosely coupled to behave as microstrip. The use of ground planes with plated-through-holes (vias) connecting all three ground layers ensures that the

system ground connects the top and bottom ground planes and provides a suitable connection to the buried microstrip (defected) ground plane on copper layer 2. Proper grounding of this buried layer is essential for optimum microstrip and DGS performance. For a traditional microstrip DGS structure with two copper layers, the ground plane with the DGS opening can radiate energy to the nearby environment. However, with the multilayer construction shown in Figure 2, the radiated energy is captured within the circuit, due to the ground on copper layer 3 and its repetitive grounding vias.

MICROSTRIP STEPPED-IMPEDANCE LPF

A microstrip stepped-impedance structure provides a way to demonstrate the effectiveness of using a microstrip DGS approach for a LPF without encountering radiation or isolation problems. The circuit consists of low-impedance sections cascaded with high-impedance sections in a repeated pattern. When designed properly, these low- and high-impedance sections produce capacitance and inductance values in different sections of the filter, resulting in a LPF function.

Using a microstrip stepped-impedance format, the difference between the high- and low-impedance sections has an effect on the spurious harmonic performance of the filter. A larger difference between the high- and low-impedance values results in less spurious harmonic content and better isolation in the stopband; however, there are limits to the impedance range that can be realized. For example, if the low-impedance circuit element is too wide, it can cause unwanted resonances that distort filter performance. As a general rule, the width of this structure should be no greater than $\lambda/8$ at the frequency of interest. Conversely, high impedances require narrow conductors difficult to fabricate in microstrip. Another general rule is that the minimum microstrip conductor width should be 4 mils or more to provide a circuit design that PCB fabricators can manufacture practically and repeatably.

To achieve high-impedance sections, DGS circuit design features are incorporated to increase the impedance of a circuit section without resulting in conductor widths that are too narrow to fabricate. One of these features is an etched opening in the microstrip ground plane under a narrow conductor. The etched opening significantly increases the substrate thickness in the area, with a resulting increase in impedance.

DGS technology can also be used to enhance filter stopband performance and minimize spurious harmonic responses. This can be done with a DGS that causes a bandstop response in the range of frequencies of the spurious harmonic responses or in the range of frequencies where the filter's stopband must be improved. In general, to control a filter's spurious harmonic responses without degrading other filter performance parameters, a narrow bandstop response is created in the frequency range where the harmonic or spurious responses are known to occur. With a DGS, it is typically better to use a wide bandstop configuration within the frequency range of interest.

To better illustrate the benefits of DGS circuit techniques for enhancing the performance of a high-fre-

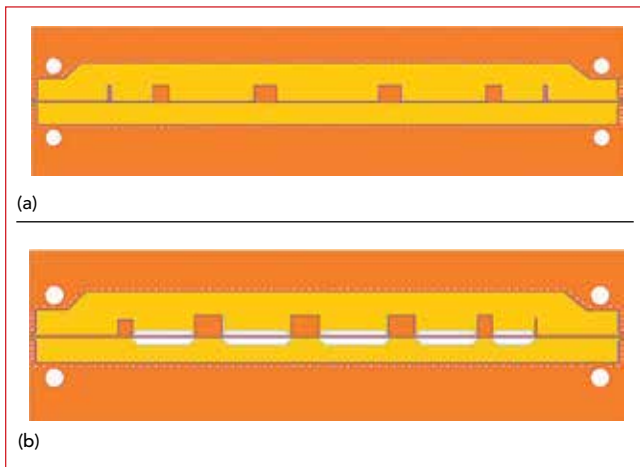

▲ **Fig. 3** Conventional microstrip stepped-impedance LPF (a), and a circuit with the same design specifications but with DGS openings in copper layer 2 to achieve high-impedance circuit features (b).

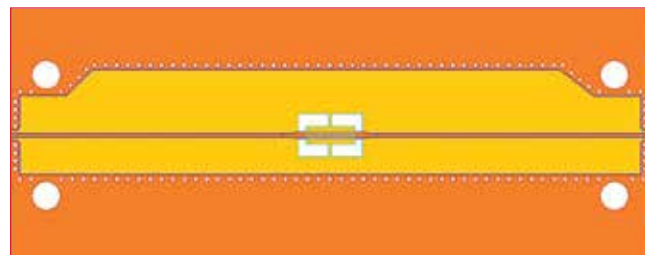

▲ **Fig. 4** Prototype microstrip transmission line with an optimized DGS bandstop feature to provide good passband return loss and high rejection at 8.4 GHz.

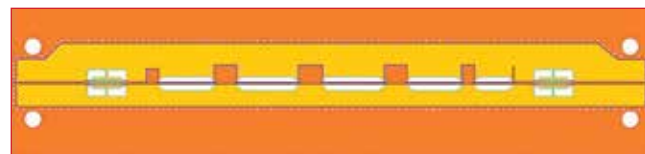

▲ **Fig. 5** Final microstrip DGS LPF circuit design, including the transmission line structure for enhanced rejection at 8.4 GHz.

quency filter, a study of the effects of a DGS on a microstrip stepped-impedance LPF is described. EM modeling is performed using several design approaches and considerations. Physical circuits are fabricated and tested, and the measured performance is compared to the simulated performance from the EM models. To fully understand DGS effects, filters are fabricated using specific combinations of high- and low- ϵ_r substrate materials to demonstrate how the choice of circuit materials impacts the performance of a microstrip DGS component.

FILTER DESIGN AND MODELING

The LPF design is based on a Chebyshev transfer function with 0.1 dB ripple and a 3 dB cutoff at 2.2 GHz. Several versions of the filter were designed and fabricated. The first is a reference, designed without a DGS. The second targets the same specifications but with two different DGS approaches and with a particular combination of high- ϵ_r and low- ϵ_r substrate materials, to form the multilayer structure of the three-copper-layer, microstrip DGS circuit.

The high- ϵ_r substrate material used for this study is 8-mil-thick RO4360G2™ laminate from Rogers Corp. It has a design Dk of 6.4. This is the relative permittivity or dielectric constant, ϵ_r , as perceived by the circuit (shown as ϵ_{r1} in Figure 2). The low- ϵ_r substrate is a 22-mil-thick 2929 bondply material, also from Rogers. It has a design Dk of 2.9 (shown in Figure 2 as ϵ_{r2}). A benefit of this material combination for the stepped-impedance microstrip DGS design is the use of the high- ϵ_r material for the low-impedance sections; low-impedance circuit features are achieved solely by using the higher ϵ_r material. When an etched opening is formed in the microstrip ground plane on copper layer 2 to construct the high-impedance circuit features, the circuit behaves as if it is based on a much thicker substrate; the thicker substrate has a combination of ϵ_r values from the two different substrate materials with design Dk values of 6.4 and 2.9. Considering the thicknesses of the two

substrate materials, the combination yields a composite design Dk of about 3.4. The thicker substrate, with its lower ϵ_r value, is used to form a higher impedance circuit feature than is possible with the 8-mil-thick substrate alone.

Figure 3a is a top view of the first LPF circuit design while the same circuit design with ground openings in copper layer 2 is shown in **Figure 3b**. The color coding shows the top copper layer (copper layer 1, the signal layer) as dark orange and copper layer 2 (the buried microstrip ground plane) as light orange. There are many repetitive grounding vias (shown as white dots) around the periphery of the circuit features. This ensures that the buried ground plane, the top ground plane and the bottom ground plane are consistently grounded together. The bottom ground plane (copper layer 3, shown in white) is below the microstrip buried ground plane (copper layer 2). If **Figure 3b** were a true microstrip DGS, with only two copper layers, the white area would represent a pathway where energy could radiate to the outside world. With the bottom ground plane (copper layer 3) present, radiated energy is minimized.

To demonstrate additional benefits of this DGS design approach, assume that excellent rejection is needed at 8.4 GHz. To achieve that performance in the LPF, during the modeling phase of the project, a simple microstrip transmission line is simulated with a specially designed ground opening on copper layer 2 as a DGS; the intent is to achieve a broadband bandstop function at 8.4 GHz. The model is optimized for the best return loss over the LPF's passband, from DC to 2.2 GHz. For improved isolation at 8.4 GHz, the circuit of **Figure 4** is included in the final DGS LPF design in the area of the filter's 50 Ω feedline. **Figure 5** shows how these circuit features combine to form the final DGS LPF design.

PERFORMANCE

Figure 6 shows $|S_{21}|$ responses of the LPF circuit without DGS features (see **Figure 6a**) and with DGS features (see **Figure 6b**). Comparing the filter responses,

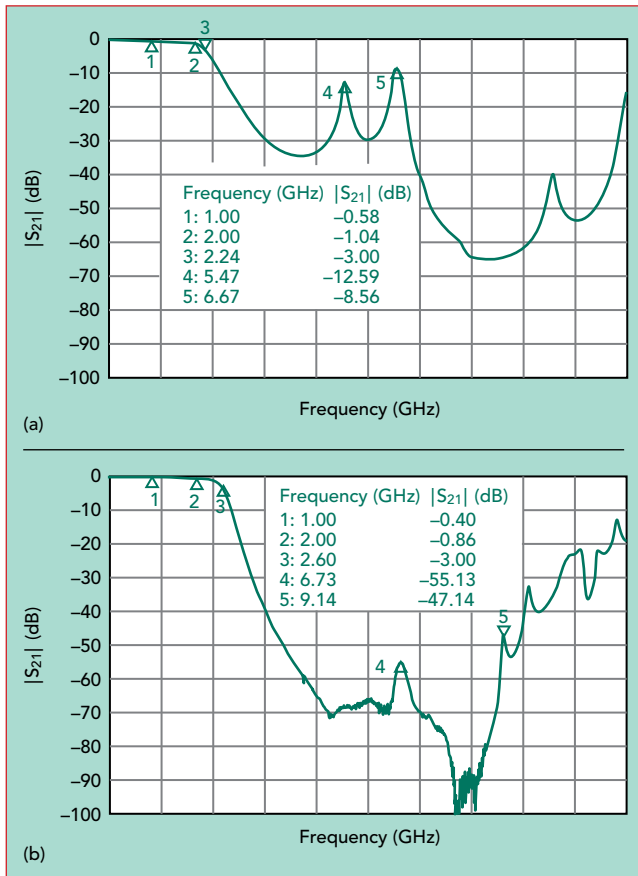

▲ Fig. 6 $|S_{21}|$ of the circuits in Figure 3a without a DGS (a) and LPF in Figure 5 (b).

note that the filter circuit with DGS was not optimized to achieve the 3 dB cutoff frequency design goal. The 3 dB cutoff frequency for the reference filter circuit (i.e., the circuit with no DGS) is 2.243 GHz (marker 3 in Figure 6a), while the 3 dB cutoff frequency for the filter circuit with DGS is 2.604 GHz (marker 3 in the Figure 6b).

Comparing the $|S_{21}|$ responses of the filters, the most notable differences occur in the stopband beyond the 3 dB cutoff points. For the circuit without the DGS, markers 4 and 5 indicate frequencies where unwanted resonances are causing poor stopband performance. Mark-

er 4 is at a resonant peak associated with the middle section of the high-impedance conductor, and marker 5 is a spurious harmonic at approximately $3f_0$, where f_0 is the 3 dB cutoff frequency. The resonance at marker 4, which is at approximately 5.47 GHz, is due to the high-impedance, narrow conductor in the middle of the circuit, which has a physical length of nearly $\lambda/2$ at 5.47 GHz, causing a standing-wave resonance for that wavelength and frequency. For the LPF circuit containing the DGS, the high-impedance sections are physically shorter and the wavelength is different in that area because the conductor experiences a thicker substrate which has a relative permittivity of the combined materials (ϵ_{r1} of 6.4 and ϵ_{r2} of 2.9). Additionally, the DGS openings produce a slow-wave effect, which allows the circuit features to be shorter. Due to these differences, the $\lambda/2$ resonance at 5.47 GHz is eliminated with the DGS structure.

Having a spurious harmonic at $3f_0$ is a natural byproduct of a microstrip stepped-impedance filter. It is well known that this spurious harmonic can be significantly suppressed if the high-low impedances of the stepped-impedance circuit features have a wider range. Marker 5 at $3f_0$ (6.671 GHz) for the circuit without the DGS shows a loss response of 8.6 dB, where the circuit with the DGS (marker 4 at $3f_0$) shows a loss response of 55.1 dB. Also note the stopband improvement at 8.4 GHz with the filter having the DGS. High losses of almost 90 dB are shown between markers 4 and 5, in the vicinity of 8.4 GHz. ■

References

1. S. K. Parui and S. Das, "A New Defected Ground Structure for Different Microstrip Circuit Applications," *Radioengineering*, Vol. 16, No. 1, April 2007, pp. 16–22.
2. L. H. Weng, Y. C. Guo, X. W. Shi and X. Q. Chen, "An Overview on Defected Ground Structure," *Progress in Electromagnetics Research B*, Vol. 7, 2008, pp. 173–189.
3. M. K. Mandal and S. Sanyal, "A Novel Defected Ground Structure for Planar Circuits," *IEEE Microwave and Wireless Components Letters*, Vol. 16, No. 2, February 2006, pp. 93–95.
4. J. Coonrod, "Harmonic Suppression of Edge Coupled Filters Using Composite Substrates," *Microwave Journal*, Vol. 55, No. 9, September 2012.
5. J. Coonrod, "Applied Methodology for Harmonic Suppression of Microstrip Edge Coupled Bandpass Filters Using Composite Circuit Materials," *European Microwave Week*, September 2015.

How to Include the Effects of Circuit Material Copper Surface Roughness in EM Simulations

The ROG Blog is contributed by John Coonrod and various other experts from Rogers Corporation, providing technical advice and information about RF/microwave materials.

Rogers Corp.

Mopper is an excellent electrical conductor for RF/microwave printed-circuit boards (PCBs). It is the foundation for low-loss transmission lines, such as microstrip and stripline. However, the surface roughness of copper can vary from one circuit material to the next, even across a single sheet of circuit material, affecting high-frequency performance. Ideally, a circuit laminate's copper would be uniformly smooth, providing consistent signal transmission characteristics across a circuit board and from board to board. But any practical copper-laminated circuit board has some amount of copper surface roughness which contributes to the final performance possible with that circuit board.

Fortunately, the latest electromagnetic (EM) simulation software allows users to include key circuit material properties, such as dielectric constant (Dk) and copper surface roughness, in the circuit design and performance simulation process, achieving simulated results that can be close to the results from measurements on an actual prototype circuit, even for circuits fabricated on circuit materials with copper surface roughness that may vary across the board.

UNDERSTANDING THAT DK VALUE

When simulating circuits in a commercial EM simulator, with the goal of including the effects of the circuit material's copper surface roughness in the simulation, it is important to understand how the copper surface roughness can affect the performance of a high-frequency circuit, and to have a good idea about the relationship between the Dk and the copper surface roughness for a particular material. In fact, because the Dk value or values for a circuit material may have been determined by including such effects as copper surface roughness, the Dk values developed for modeling purposes in EM simulators are often referred to as "Design Dk" values.

Depending upon the severity of the copper surface roughness, for example, it can result in unexpected variations in the phase response of a circuit fabricated on that material. Those variations can become more significant at higher frequencies (with smaller wavelengths), such as millimeter-wave frequencies being used at pres-

ent in advanced driver assistance systems (ADAS) electronic safety systems in automobiles and being planned for high-speed, short-haul data links in Fifth Generation (5G) wireless communications networks.

The Design Dk value for any circuit material is dependent upon frequency, often referenced to a test frequency of 10 GHz. The value may be different at other frequencies. Design Dk is obtained from testing microstrip transmission line circuits and extracting the Dk value from circuit performance, based on the z-axis (thickness) of the material.

Some EM simulators may work with only z-axis Design Dk values while others may require values for both the z-axis and x-y plane Dk of a circuit material. The Dk value for the material in the x-y plane is typically used in software when anisotropy data can be entered.

WHICH DK MEASUREMENT?

The Design Dk values of a circuit material are extremely important to the accuracy of an EM circuit simulation, and it is helpful to know the manner in which a circuit material manufacturer determined the published Design Dk values for a particular material. The Design Dk of a circuit material is found by using the microstrip differential phase length test method.

While it is possible to determine the Dk value of bulk circuit materials through measurement under extremely controlled environments, many Dk test methods are based on the use of known circuits, such as the microstrip ring resonator method and the microstrip differential phase length method. Measurements of the performance of these fabricated circuits reveal information about the circuit material which helps determine its Dk value, again under those precise test conditions (frequency). Unfortunately, any variations in the circuitry, such as in conductor etching and copper plating thickness, can cause errors in the determination of a material's Dk value. When a multilayer reference circuit, such as a stripline-based circuit, is used to find a material's Dk, additional variables can corrupt the measurements for determining a circuit material's Dk value. For example, the thicknesses of the multilayer's inner layers may vary, or the Dk of the bonding materials used to attach

the multiple layers may differ from the Dk of the core circuit material. Such variables must be accounted for when determining the Dk or, ultimately, the Design Dk of a circuit material that can most accurately be used in an EM simulator.

Circuit materials from Rogers Corp. are characterized in terms of Design Dk values, determined by means of extracting Dk values of a material based on measurements of well-known microstrip transmission-line circuits fabricated on the material. These Design Dk values are included on circuit material data sheets and do not include the effects of copper surface roughness. However, within the MWI-2018 software, available for free download from the Rogers Tech Support Hub www.rogerscorp.com/techub, much more information is also available that is extremely useful for circuit modeling in a commercial EM simulator.

Rogers' MWI-2018 software can show Design Dk values for each circuit material with a variety of options. One option is Bulk Dk, for the material alone, without copper surface roughness effects. This is the Design Dk value that should be used with an EM simulator that has its own built-in capability to calculate the effects of circuit material copper surface roughness on a circuit's phase response, and does not need a Design Dk value that is "preloaded" with factors that will enable the prediction of copper surface roughness effects when the EM simulator does not have the built-in calculator.

Numerous commercial EM simulators are now available for modeling circuits which can include the effects of circuit material copper surface roughness on phase response, such as the HFSS EM simulator from ANSYS,

CST Studio Suite from Computer Simulation Technology, and the Sonnet Suites of EM simulation software from Sonnet Software. The ANSYS HFSS software is quite capable of predicting circuit phase effects due to circuit laminate copper surface roughness; unfortunately, a blog posted earlier this year stated otherwise, which was in error and apologies are due to ANSYS. These EM simulators already calculate the effects of copper surface roughness on a circuit's phase performance and do not need additional data or Design Dk values that have been determined in a way that they are meant for use with EM simulators without the capability to include copper surface roughness effects.

For EM simulators without the capabilities to predict the effects of a circuit material's copper surface roughness, Design Dk values other than these "Bulk Dk" values should be used, and these values are also available within the free MWI-2018 software. This choice of Design Dk values for a given EM simulator will impact the accuracy of the simulated results. For the EM simulators with the capability to predict the effects of a circuit material's copper surface roughness on a circuit's phase response, the Bulk Dk values are the best choice, since the EM simulator is already accounting for those phase effects and there is a kind of "doubling" effect due to the phase effects being also accounted for in the Design Dk values that were determined by extraction of measurements performed on a reference circuit fabricated on the circuit material.

Do you have a design or fabrication question? Rogers Corporation's experts are available to help. Log in to the Rogers Technology Support Hub and ["Ask an Engineer"](#) today.■

**Have you Visited the
Technology Support Hub
Recently?**

- New Product Info
- Calculators
- Video Library
- Literature
- Technical Papers
- White Papers
- Ask an Engineer
- Instructional Videos
- Webinars
- Tools
- ... Much More!

ROGERS CORPORATION
rogerscorp.com

LOGIN HERE

The advertisement features a cartoon character with a square head, glasses, a blue suit, and a red cape, holding a tablet. In the background, there are images of Rogers products, including a '4G 5G' box and a 'Copper's Corner' box, and a circular inset showing a smaller version of the character.

Evaluate PCB PTHs For 5G Application

John Coonrod
Rogers Corporation

The broad range of frequencies covered by 5G wireless networks places special requirements on the circuit materials used in 5G circuits, operating through millimeter-wave frequencies. This study explores the effects of the surface roughness of the walls of PTH viaholes used for signal transitions from top and bottom copper layers in PCB materials on the ultimate RF performance of the material.

Fifth-Generation (5G) wireless networks are being touted as one of the greatest technology advancements to reach modern electronic communications, making use of signal carrier frequencies below 6 GHz as in earlier wireless communications generations, but also reaching well into millimeter-wave frequencies for short-haul, high-speed data links. Fabricating circuits for such a wide range of frequencies coverage calls for a special circuit laminate, and RO4730G3™ laminates from Rogers Corp. caught the attention of many circuit designers for its outstanding performance from RF through millimeter-wave frequencies. However, one difference between this laminate and more traditional circuit materials which was cause for concern among some circuit designers was the use of hollow microspheres as fillers for the substrate.

Because of the microspheres, the appearance of micromachined circuit formations, such as plated-through-hole (PTH) viaholes from one conductive copper layer to another, can appear much rougher than PTH viaholes formed in more-traditional circuit materials without such substrate fillers. Can looks be deceiving, or is there any cause for concern because of the rough appearance of PTH viaholes in circuit laminates with microsphere fillers? Several studies have shown that the impact of the microsphere fillers on the PTH viaholes is purely cos-

metic and does not affect circuit performance or PTH viahole reliability, whether at RF or through the higher millimeter-wave frequencies so essential to 5G wireless networks.

COMPARING PTH VIAHOLES

The wall surfaces of all circuit PTH viaholes can vary in texture, even when comparing the roughness of PTH viahole wall surfaces for viaholes in the same laminate. The wall surfaces of the PTH viaholes will vary from hole to hole simply due to multiple factors involved with the drilling process. In a material with microsphere fillers, a drill may or may not impact a microsphere filler, accounting for differences. When the drill impacts and fractures a hollow sphere, copper plating for that viahole will follow the contour of the opened sphere and the viahole wall will not be smooth and flat. Figure 1 shows how the presence of microsphere fillers in a circuit laminate can affect the surface roughness of the PTH viaholes formed in that circuit material. It is only natural to question whether the roughness would translate into any difference in electrical performance or reliability compared to a more traditional circuit laminate in which PTH viaholes can have smoother appearances.

With the growing need for high-frequency circuit materials capable of supporting the wide range of frequencies in 5G wireless networks, it is meaningful to understand the effects, if any, of the surface roughness of the PTH viaholes in circuit laminates with hollow microsphere filler versus more traditional circuit laminates without such filler. Several studies were performed to compare circuit material with glass reinforcement and microsphere filler, 20.7-mil-thick RO4730G3 circuit laminate from Rogers Corp., with an advanced circuit

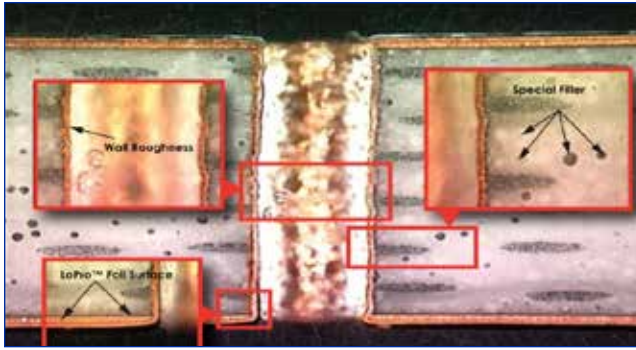

▲ Fig. 1. Circuit laminates such as RO4730G3 which use hollow microsphere fillers may form PTH viaholes with rough wall surfaces compared to circuit laminates without microsphere fillers.

laminate without glass reinforcement and with much smaller, not hollow, filler, 20-mil-thick RO3003G2™ circuit laminate, also from Rogers Corp. Numerous different test circuits were developed to compare the circuit laminates and their PTH viaholes to better understand the impact, if any, of the surface roughness of the viahole walls across the wide range of frequencies that will be needed in 5G wireless communications networks.

Many of the test circuits were based on microstrip transmission lines with a single viahole transition in the middle of the circuit serving as the transition for a single conductor from the top copper layer to the bottom copper layer of a substrate material. Most of these test circuits were 2 in. long. Additional high-frequency transmission-line technologies were used in this evaluation of PTH viahole surface wall roughness, including 8- and 2-in.-long microstrip circuits without signal viahole transitions and 8- and 2-in.-long grounded-coplanar-waveguide (GCPW) transmission-line circuits without signal viahole transitions. To maintain consistency in measurements with a commercial vector network analyzer (VNA), two 2.4-mm end-launch coaxial connectors from the same manufacturer were used for all the measurements. The pressure-contact connectors were always oriented in the same way to the VNA's test ports for phase consistency.

Designers accustomed to studying microscopic images of printed circuit boards (PCBs) such as in **Figure 1** may feel concern for the roughness of the PTH viaholes that connect the copper conductor layers of the material, especially for the high frequencies that will be needed for 5G wireless network circuits. In general, and for traditional high-frequency circuit materials not using microsphere filler, a rough wall surface for the viahole can indicate a problem in the PCB fabrication process for that circuit material, with possible concern for viahole reliability. But for circuit materials with hollow microsphere filler, PTH viaholes formed with rough surfaces are normal and in no way indicative of poor performance. To confirm that the rough PTH viahole wall surface is not a concern for PCB reliability and electrical performance in such circuit materials, focused research was performed to compare the novel materials (and their rougher PTH viaholes) to more traditional circuit laminates (and their smoother PTH viaholes), to dispel

any concerns for using this material for 5G wireless circuits and any other applications reaching well into the millimeter-wave frequency ranges.

Prior to evaluating the impact of PTH viaholes and their wall surfaces on high-frequency circuit performance, RO4730G3 circuit laminates with their microsphere fillers were extensively evaluated to fully understand their characteristics under different operating conditions. Studies on the material included 10-layer highly accelerated thermal shock (HATS)/PTH reliability, double-sided PTH reliability, double-sided PTH:PTH conductive-anodic-filament (CAF) resistance, plane:plane CAF resistance, MOT and surface-mount-technology (SMT) testing, insulation resistance, quality of PTH viaholes, and more. As all these different studies showed, the material and its microsphere fillers had no problems passing these tests under industry standard testing conditions. Additional information from any of these studies can be found on the Rogers Corporation Technology Support Hub, www.rogerscorp.com/techub. The present article focuses on any possible issues in using the material at RF, microwave, and millimeter-wave frequencies.

In fact, of the multiple studies performed on this circuit material and its microsphere fillers, one study did focus on any impact on RF performance due to PTH viahole wall surface roughness variations, looking at two different materials with different PTH viahole wall characteristics. The study employed a specially designed microstrip transmission-line test circuit, with the signal conductor making a transition from the top copper layer, through the low-loss dielectric substrate, to the bottom copper layer. These test circuits, designed to provide meaningful data for 5G applications, exhibit good RF performance from 100 MHz to 40 GHz.

The two materials used in this study had similar dielectric constant (Dk) or relative permittivity (ϵ_r) of approximately 3. The two materials were also the same thickness, 20 mils thick. The main difference between them was that one could produce a smooth PTH viahole wall surface and the other could have a much rougher PTH viahole wall surface. RO3003G2 circuit laminate from Rogers Corp. was the material with the smooth PTH viahole wall surfaces while RO4730G3 circuit laminate with glass reinforcement and hollow microsphere filler was the material for the rough PTH viahole wall surfaces.

The texture of a circuit PTH viahole wall surface is usually considered to be more of a circuit fabrication issue than a material issue. Still, some material characteristics can make a difference in PTH viahole wall surface, including circuit material filler type, filler size, glass reinforcement, and resin type. In comparing RO4730G3 laminate and its hollow microsphere fillers (and rough PTH viahole wall surfaces) with RO3003G2 laminate, which has no glass reinforcement and extremely small filler, smoother PTH viahole wall surfaces might be expected for the latter assuming that optimum PCB fabrication methods were used for both materials. In fact, as **Figure 2** shows, RO3003G2 circuit laminates can produce quite smooth wall surfaces for their PTH viaholes.

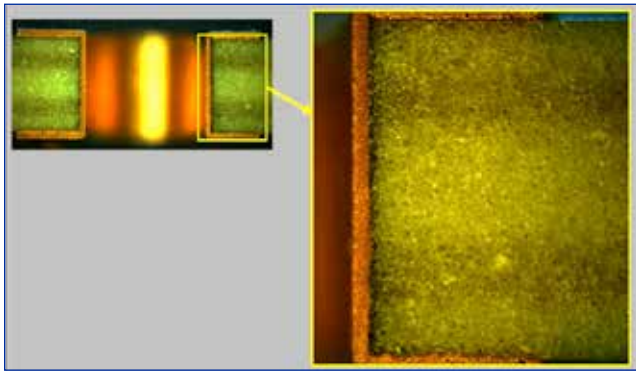

▲ Fig. 2. This microscopic image shows the relatively smooth wall surface of a PTH viahole formed in 20-mil-thick RO3003G2 circuit laminate.

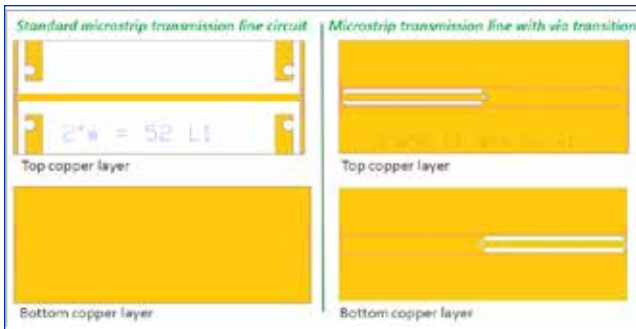

▲ Fig. 3. These images represent a standard microstrip transmission line (left) and the microstrip test circuit with PTH viahole transition (right) used to evaluate the effects of PTH viahole wall surface roughness on RF performance at high frequencies.

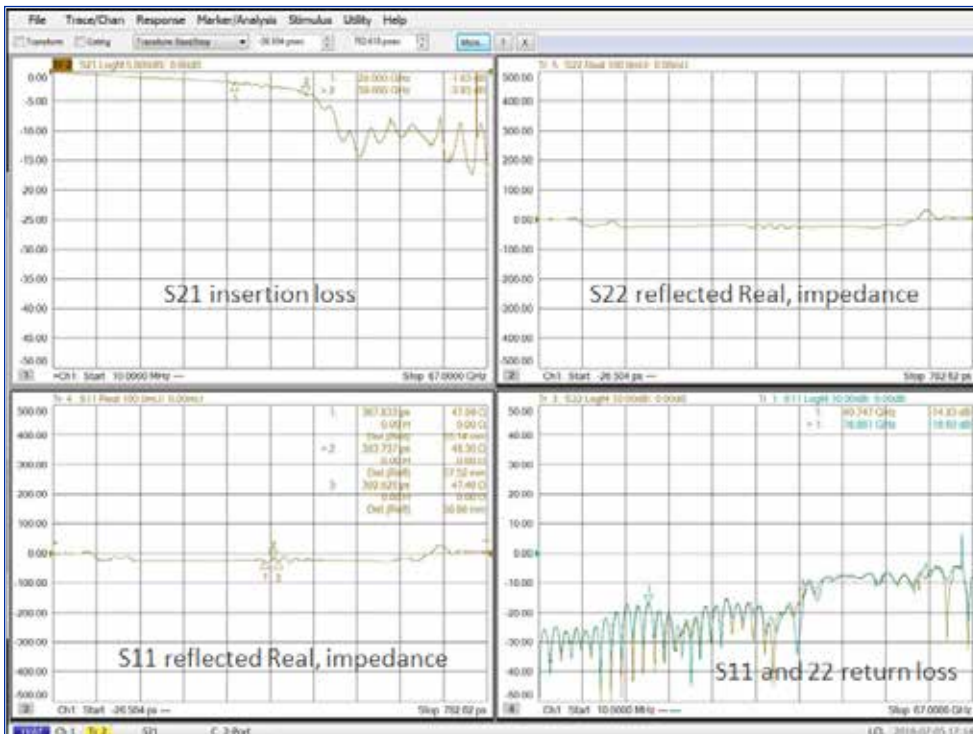

▲ Fig. 4. This is an example of the S-parameter data collected with a commercial VNA from the different circuits and their PTH viaholes with different wall surface textures. Data are shown in both the frequency and time domains.

The differences in the surface roughnesses of the PTH viaholes of the two materials shown in Figures 1 and 2 are clear, for two circuit laminates with the same thickness. One question from looking at these images might be, will the greater surface roughness of the PTH viaholes mean anything in terms of RF performance? For a test vehicle, it was felt that a microstrip transmission-line circuit would provide an effective means of comparing the effects of smooth and rough PTH viahole wall surfaces on otherwise similar circuit materials, since PCB fabrication variables for microstrip have less impact on RF performance than for other high-frequency transmission-line formats.

A great deal of effort was invested in optimizing these microstrip test circuits and measurement procedures to provide meaningful results for the PTH viaholes in the different circuit materials through 40 GHz. One of the challenges in achieving good high-frequency results is the signal launch from the RF test connector to the PCB circuitry, the microstrip lines. Typically, the signal launch will suffer poor return loss for a microstrip transmission line on 20-mil-thick laminate, especially above 25 GHz. Return loss of 15 dB or better is usually considered acceptable for broadband microstrip circuits.

The viahole transition was another important consideration in these studies, especially because of the difficulty of achieving low-loss transitions from one copper layer to another at millimeter-wave frequencies. Typically, good performance for microstrip viahole transition on thick (20 mil) circuit material is difficult beyond 20 GHz. But, considering these challenges, the microstrip test circuits for this study, as shown in **Figure 3**, were designed with the goal of achieving good results to 40 GHz.

The “standard” microstrip circuit shown on the left-hand side of Figure 3 is a microstrip circuit launched by means of grounded coplanar waveguide (GCPW) structure. The main body of the circuit consists of microstrip transmission lines, but the GCPW structures are used at the ends of the circuit to launch to the coaxial (2.4-mm) connectors (model #1492-04A-5 from Southwest Microwave). Figure 3 shows the top and bottom circuit layers of the test vehicle used for this study. They are loosely coupled GCPW with a PTH viahole in the middle to provide a transition from the top to the bottom circuit layers. The test circuit is 2 in. in length and a loosely coupled GCPW transmission-line circuit will have very similar RF performance to a microstrip transmission-line cir-

Circuit ID	Phase angle measurements (deg)			Phase angle differences (deg)		
	24 GHz	28 GHz	39 GHz	24 GHz	28 GHz	39 GHz
No via	-3189	-3728	-5237	reference	reference	reference
P1 C1	-3167	-3708	-5237	22	20	0
P1 C2	-3169	-3711	-5241	20	17	-5
P1 C3	-3165	-3706	-5233	24	23	3
P1 C4	-3163	-3704	-5231	26	24	6
P1 C5	-3165	-3706	-5234	23	22	3
P1 C6	-3166	-3707	-5236	23	21	0
No via	-3186	-3725	-5233	reference	reference	reference
P2 C1	-3167	-3707	-5233	19	18	0
P2 C2	-3165	-3706	-5231	21	19	2
P2 C3	-3164	-3704	-5227	22	22	6
P2 C4	-3163	-3703	-5226	23	23	7
P2 C5	-3165	-3705	-5229	21	20	4
P2 C6	-3161	-3701	-5223	25	25	10

Panel 1 statistics for phase angle differences			
	24 GHz	28 GHz	39 GHz
average	22.93	21.13	1.11
Std dev	1.91	2.32	3.56
range	5.64	6.76	10.13

Panel 2 statistics for phase angle differences			
	24 GHz	28 GHz	39 GHz
average	22.00	21.20	4.83
Std dev	2.13	2.40	3.62
range	5.93	6.70	9.97

▲ Fig. 5. These S21 unwrapped phase angle measurements are for 2-in.- long microstrip transmission-line circuits using a PTH viahole to transition from top to bottom copper layers. The circuit material is 20-mil-thick RO3003G2, which can form very smooth PTH viahole wall surfaces.

cut. The loose coupling supports good performance at higher frequencies and is a good fit for this test vehicle through 40 GHz.

Figure 4 shows the screen shot of a commercial microwave/millimeter-wave VNA, with results plotted in both the frequency and time domains. The return loss in the lower-right-hand corner (S11 and S22) has two markers indicating return-loss values at different frequencies. Marker 2 is at 40.7 GHz, the highest frequency where good return loss was measured for this test vehicle. The impedance of reflected S22 is shown in the upper right-hand corner and the impedance of reflected S11 is in the bottom left-hand corner. As the markers for S11 show, the body of the test circuit has an impedance of about 48 Ω, with markers 1, 2, and 3 in the viahole transition. Small impedance anomalies can be seen in the viahole transition areas, although these are less than 2 Ω in impedance and have little impact on the RF performance of the circuit. With these test results, this circuit is considered to have a good viahole transition from top to bottom signal layers. It also exhibits good insertion-loss performance (upper-left-hand corner) through 40 GHz.

Many circuits of the same design were fabricated from the same circuit material panel to better understand RF performance variations that might result from normal material variations as well as the effects of variations resulting from PCB fabrication processes. Multiple panels, panels 1 and 2, were used to fabricate many test circuits, although these two panels began as part of the same larger panel of material.

The original circuit material panel measured 24 × 18 in. and was cut into two panels, each measuring 12 × 18 in., so that material consistency would be maintained across the different test circuits. The same test circuit fabrication and testing scheme was used for both circuit materials used in the fabrication of the microstrip test circuits, the 20-mil-thick RO3003G2 circuit material for the smooth PTH viaholes and the 20.7-mil-thick RO4730G3 circuit materials for the rougher PTH viaholes.

SORTING TEST RESULTS

A large amount of data was collected for this circuit material study, measuring the following for each circuit tested: insertion loss, return loss, impedance, group delay, and phase angle (as shown in Figure 4). Through-measurements were used to determine the effects of a PTH viahole serving as a transition from one copper layer to another copper layer in a circuit board. Impedance was measured for the test circuits, but it was not considered the best barometer of the effects of the PTH viahole on

RF performance. Impedance for microstrip circuits (or loosely coupled GCPW) is most influenced by substrate thickness, then conductor width, variations in copper thickness, and substrate Dk. The impedance in the PTH viahole transition area will be more impacted by these variables than any variation in the wall surface of the PTH viaholes. For this reason, impedance was not used to gauge the effects of the PTH viahole wall surfaces on RF performance, although the impedance data was collected.

S21 phase angle was used as a measure of circuit laminate RF variations due to PTH viahole wall surface variations, since the surface roughness of a conductor along a microstrip transmission line will impact the phase angle of a signal through that transmission line.^{1,2} The through-measurement is sensitive to the RF signal path going through the transitioning viahole. Repeatability studies conducted on one of the test circuits found that S21 phase angle measurements can be performed within a standard deviation of ±1.2 deg. at 39 GHz. For this PTH viahole study, the S21 phase angle results refer to the S21 unwrapped phase angle, basically an absolute-value summation of the -180 to +180 deg. phase angle reported for such measurements. This is meaningful resolution for 5G frequencies to 39 GHz, where lower frequencies are less sensitive to phase variations. In addition, for a 2-in.-long microstrip transmission line on circuit material with Dk of about 3, the phase angle range will be in the thousands of degrees at 39 GHz, so that suitable phase resolution is provided by the test circuits and the measurement scheme.

While the amount of data collected on these PTH viahole studies is extensive, some of the results can be shared here. For example, Figure 5 first shows data for six different circuits of the same design fabricated on the same panel of material and compared to a microstrip transmission line without the viahole transition for reference. Figure 5 also shows data for six different circuits of the same design fabricated on a second panel of circuit material (where the two panels were originally cut from the same piece of material). The test results are for circuit material capable of smooth PTH viahole wall surfaces.

Circuits using RO3003G2 materials (smooth PTH via hole wall)			
Panel 1 statistics for phase angle differences			
	24 GHz	28 GHz	39 GHz
average	22.93	21.13	1.11
Std dev	1.91	2.32	3.56
range	5.64	6.76	10.13
Panel 2 statistics for phase angle differences			
	24 GHz	28 GHz	39 GHz
average	22.00	21.20	4.83
Std dev	2.13	2.40	3.62
range	5.93	6.70	9.97

Circuits using RO4730G3 materials (rough PTH via hole wall)			
Panel 1 statistics for phase angle differences			
	24 GHz	28 GHz	39 GHz
average	23.85	24.03	7.70
Std dev	2.28	2.73	3.29
range	6.06	6.89	7.60
Panel 2 statistics for phase angle differences			
	24 GHz	28 GHz	39 GHz
average	19.68	18.61	-4.16
Std dev	2.23	2.74	4.05
range	6.83	8.31	10.47

▲ Fig. 6. These statistics for phase angle differences compare microstrip transmission-line circuits fabricated on different circuit laminates at three key 5G frequencies. The values on the left-hand side are for a circuit laminate with smooth PTH viahole wall surfaces while the values on the right-hand side are for a circuit laminate with rougher PTH viahole wall surfaces.

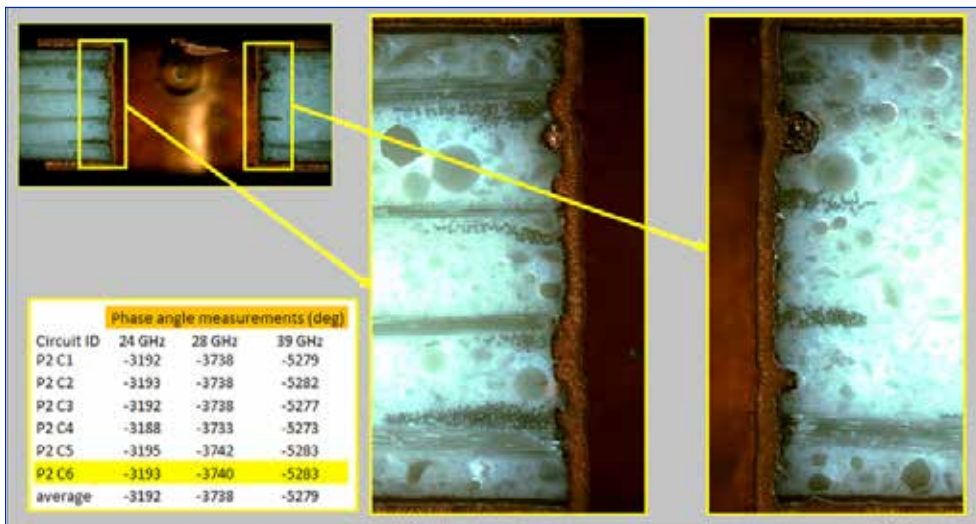

▲ Figure 7. These close-ups and phase measurements at three 5G millimeter-wave frequencies show a circuit laminate (RO4730G3) with PTH viahole (with rough wall surfaces) for signal transitions from top to bottom copper conductor layers.

The circuit ID in Figure 5 indicates what panel the circuit came from and the circuit ID on that panel. For example, P1 C4 is from panel 1, circuit number 4. Circuits were located far from each other and evenly cover the panel to achieve consistency. Some variations are to be expected, which are very sensitive to phase angle differences. Some variations are due to PCB fabrication rather than PTH viahole wall roughness, and these are conductor width variations, copper plated thickness variations, and drilled hole quality variations. In addition, the tight gaps around transitioning PTH viaholes will exhibit some variations due to normal PCB fabrication tolerances. Also, minor material variations across each panel, such as slight variations in Dk value, can result in variations. Considering the test values shown in Figure 5, the repeatability of the phase data is valid to ± 1.2 deg. at 39 GHz, which is quite good.

Although not a factor in these measurements, the Dk tolerance of the RO4730G3 circuit material which is the

source of the PTH viaholes with the rough wall surfaces is held within ± 0.05 which is considered quite good. At higher frequencies, however, even slight Dk variations can sometimes be noticeable: at 39 GHz, for example, a Dk shift of 0.05 will cause a change in phase angle of about 15.3 deg. For a tolerance of ± 0.05 or total Dk shift of 0.10, the phase angle at 39 GHz could shift by as much as 30.6 deg. due to circuit material Dk variation alone. This value is good to keep in mind for reference, when considering the phase angle variation numbers in Figure 5. But because the same original panel of material served as the source of circuit material panels for these PTH viahole evaluations, variations in phase angle in this study due to Dk variations can be expected to be minimal. But for studies performed on circuit materials with wider variations, greater phase variations can be expected. Figure 6 provides a comparison of circuit laminates with smooth PTH viahole walls (repeating results for RO3003G2 from Figure 5) and circuit laminates with rough PTH viahole walls (RO4730G3).

As noted, every attempt was made during these studies to minimize variations due to the material, with material panels 1 and 2 in each case coming from the same starting panel. Comparisons of phase angles and any differences is mostly due to circuit fabrication effects. When analysis of results is limited to a single panel, phase angle differences should have minimal influence due to PCB fabrication and minimal influence because of material variations. Because of this, the study of circuits on only one panel provides good insight into the PTH viahole quality for the microstrip circuits on that panel. PCB fabrication procedures can still result in rougher-than-expected PTH viahole wall surfaces. As **Figure 6** shows, each panel exhibits some variation in S21 unwrapped phase angle, but the variation is not significant when considering circuits fabricated on two different materials.

Visibly, using microphotographs, the surface walls of the PTH viaholes used to transition from one circuit material copper layer to another can appear quite dif-

ferent. For example, Figure 2 shows the transitioning PTH viahole for the circuit with ID P1 C1, fabricated on 20-mil-thick RO3003G2 laminate, which can form smooth PTH viahole wall surfaces. The appearance of the transitioning PTH viahole for the circuit with ID P2 C6 shown in **Figure 7**, fabricated on 20.7-mil-thick RO4730G3 circuit material, which is more likely to yield a rough PTH viahole wall surface, is much rougher. Judging by appearance alone, there might be some cause for concern regarding the effects of this PTH viahole wall surface roughness on RF performance. However, several studies have shown that, with respect to the test vehicles considered, differences between rough and smooth appearing PTH viahole side walls appear to be only cosmetic, with there being no apparent impact on RF/microwave/millimeter-wave performance, at least through 40 GHz. (It is recommended that each proposed circuit design be evaluated by the end user to confirm acceptable performance.)

It should be noted that the information reported here is a small sampling of the data collected in these studies of circuit materials with smooth and rough PTH viahole transitions. Although the purpose of these studies was to demonstrate the minimal effects of PTH viahole surface-wall roughness on RF performance, at millimeter-wave frequencies, a great deal more information is available from these studies by contacting a local representative from Rogers Corp.■

References

1. J. W. Reynolds, P. A. LaFrance, J. C. Rautio, and A.F. Horn III, "Effect of conductor profile on the insertion loss, propagation constant, and dispersion in thin high frequency transmission lines," DesignCon 2010.
2. A. F. Horn III, P. A. LaFrance, C. J. Caisse, J. P. Coonrod, and B. B. Fitts, "Effect of conductor profile structure on propagation in transmission lines," DesignCon 2016.



Download Our APP For iPad, iPhone & Android devices

Access Rogers' calculators, literature, technical papers and request samples on your smart phone or tablet through the ROG Mobile App!

Available on the **App Store**



www.rogerscorp.com/rogmobile

 **ROGERS**
CORPORATION

3G

4G

5G

2G

Rogers RO4730G3™ Patented Hollow-Sphere Laminates

RO4730G3™ antenna laminates use Rogers' original patent protected hollow-sphere technology. You can depend on Rogers for innovation leadership, reliability, and experience.

Rogers' innovation engine delivers again! Using patent protected hollow-sphere technology, Rogers RO4730G3 circuit laminates have been engineered for next-generation wireless PCB antennas – delivering reliable performance at 3.0 Dk for more than 3 years.

These low-loss, cost-effective circuit materials are lead-free process compatible and flame retardant. RO4730G3 laminates support broadband antenna designs with excellent PIM performance, outstanding dimensional stability and multilayer board design capability.

Built on the proven technology used in Rogers RO4000® thermoset resin/ceramic/woven glass materials, RO4730G3 94 V-0 laminates expand Rogers antenna grade product family, already the most popular for base station antennas.

For tomorrow's PCB antennas today — RO4730G3 Laminates



MATERIAL	Dk	PIM*
RO4730G3 Ceramic Hydrocarbon	3.0	<-160 dBc
RO4700JXR™ Series Ceramic Hydrocarbon	2.55 to 3.0	<-160 dBc
RO4500™ Series Ceramic Hydrocarbon	3.3 to 3.5	<-157 dBc
AD Series™ PTFE	2.5 to 3.2	<-157 dBc

* On 0.060" (1.524mm) laminate



Download the
**PIM and PCB
Antennas
Brochure**



Advanced Connectivity Solutions

USA - AZ, tel. +1 480-961-1382

EUROPE - BELGIUM, tel. +32 9 235 3611

www.rogerscorp.com