

ODU DOCK



A PERFECT ALLIANCE.

Connectors for Docking and Robot Systems

Clarke & Severn Electronics Ph +612 9482 1944 Email Sales@clarke.com.au www.clarke.com.au
webshop www.cseonline.com.au



Robust Circular Connectors ODU DOCK



Applications

- Industrial robots
- Tool change and depot systems
- Cable connections for robot systems
- Test equipment

Features

- Good safeguarding against failure
- Best guidance features
- Robust design
- High quality standards
- Easy handling during servicing
- Easy to use
- High number of mating cycles/
long lifetime
- Flexible insert configuration
- Best electrical features

All shown connectors are according to DIN EN 61984:2009 connectors without breaking capacity (COC).

All dimensions are in mm. Some figures are for illustrative purposes only. Subject to change without notice. Errors and omissions excepted. We reserve the right to change our products and their technical specifications at any time in the interest of technical improvement. This publication supersedes all prior publications. This publication is also available as a PDF file that can be downloaded from www.odu-connectors.com

Data transmission protocols

These ODU specific connectors can transmit common data transmission protocols such as CAT 6_A, Ethernet, Firewire® or USB® 3.1 Gen1, but they are not CAT, Ethernet Firewire® or USB® standard connectors.

Issue: 2018-04

Table of Contents (Part I)

Chapter		From Page	
1	Product description ODU DOCK	<u>7</u>	
	Main fields of application	<u>8</u>	
	Advantages	<u>9</u>	
	Housing versions	<u>10</u>	
	Contact inserts	<u>11</u>	
	ODU SPRINGTAC	<u>12</u>	
	Inserts with quick-change head technology	<u>13</u>	
	Order information	<u>14</u>	
2	ODU DOCK size 1	<u>17</u>	
	Housing	<u>18</u>	
	Pin and socket inserts with crimp termination	<u>20</u>	
	Pin and socket inserts with solder termination	<u>23</u>	
	Quick-change head system with crimp termination	<u>26</u>	
	Current carrying capacity for fully equipped inserts	<u>27</u>	
3	ODU DOCK size 2	<u>31</u>	
	Housing	<u>32</u>	
	Pin and socket inserts with crimp termination	<u>34</u>	
	Pin and socket inserts with solder termination	<u>37</u>	
	Quick-change head system with crimp termination	<u>40</u>	
	Current carrying capacity for fully equipped inserts	<u>41</u>	
4	ODU DOCK Größe 3	<u>43</u>	
	Housing	<u>44</u>	
	Pin and socket inserts with crimp termination	<u>46</u>	
	Pin and socket inserts with solder termination	<u>51</u>	
	Quick-change head system with crimp termination	<u>57</u>	
	Insert with modular construction	<u>58</u>	
	Modules from the ODU-MAC program	<u>59</u>	
	Current carrying capacity for fully equipped inserts	<u>65</u>	
5	ODU DOCK accessories	<u>69</u>	
	Accessories	<u>70</u>	
	ODU DOCK assembly instruction and crimp information	<u>71</u>	
	Assembly instruction	<u>72</u>	
	Crimping tools and contact preparation	<u>73</u>	
	Removal tools for crimp contacts	<u>77</u>	

Table of Contents (Part II)

Chapter		From Page	
6	Application specific connectors for Docking and Robot Systems	<u>79</u>	
	Additional docking connectors	<u>80</u>	
	Application specific docking systems	<u>81</u>	
7	Technical information	<u>83</u>	
	International Protection (IP) Classes in accordance with DIN EN 60 529	<u>84</u>	
	Explanations and information according to VDE	<u>85</u>	
	Conversions AWG – gross section	<u>88</u>	
	Principles of current carrying capacity	<u>89</u>	
	Current load	<u>90</u>	
	Line current load	<u>91</u>	
	Technical information / definitions / terms	<u>92</u>	
8	Company information	<u>95</u>	
	Quality management	<u>96</u>	
	Your partner in many application areas	<u>97</u>	
	The complete ODU product range	<u>98</u>	
	Everything from one source	<u>99</u>	
	Application specific connectors	<u>100</u>	

Connectors for Docking and Robot Systems – a Special Kind of Connector

Connectors for Docking and Robot Systems are connectors that have restricted guidance and that can be inserted automatically. The force can be applied manually, electrically or pneumatically.

Connectors for Docking and Robot Systems require simple constructed connectors with very different contacts. Often a large number of mating cycles are called for. The docking system stands or falls on the guide and the contact system that are selected.

Following are some of the features that are critical when connectors for Docking and Robot Systems are used:

- Good safeguarding against failure
- Best guidance features
- Robust design
- High quality standards
- Easy handling during servicing
- Easy to use
- High number of mating cycles / long lifetime
- Flexible insert configuration
- Best electrical features.

Connectors for Docking and Robot Systems are ideally suited for such use and satisfy these requirements.

From simple standard connectors for Docking and Robot Systems to the complex docking unit – ODU supplies the complete range.



Application of Connectors for Docking and Robot Systems

Connectors for Docking and Robot Systems have become indispensable in automation engineering. Industrial robots, tool change and depot systems, cable connections and test equipment are just a few examples of the applications for these systems. ODU docking systems are built into combined quick coupling systems (electrical/pneumatic) where they enable the greatest possible flexibility.

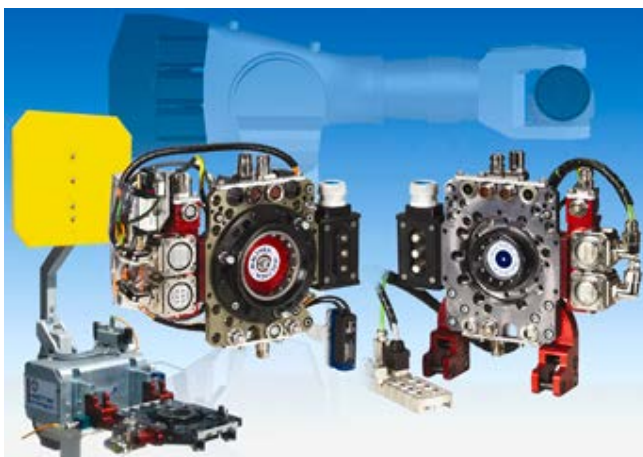

Product Description

ODU DOCK



Main Fields of Application

ODU DOCK systems are mostly used for the following applications:

- Tool change and depot systems
- Test equipment
- Industrial robot systems.

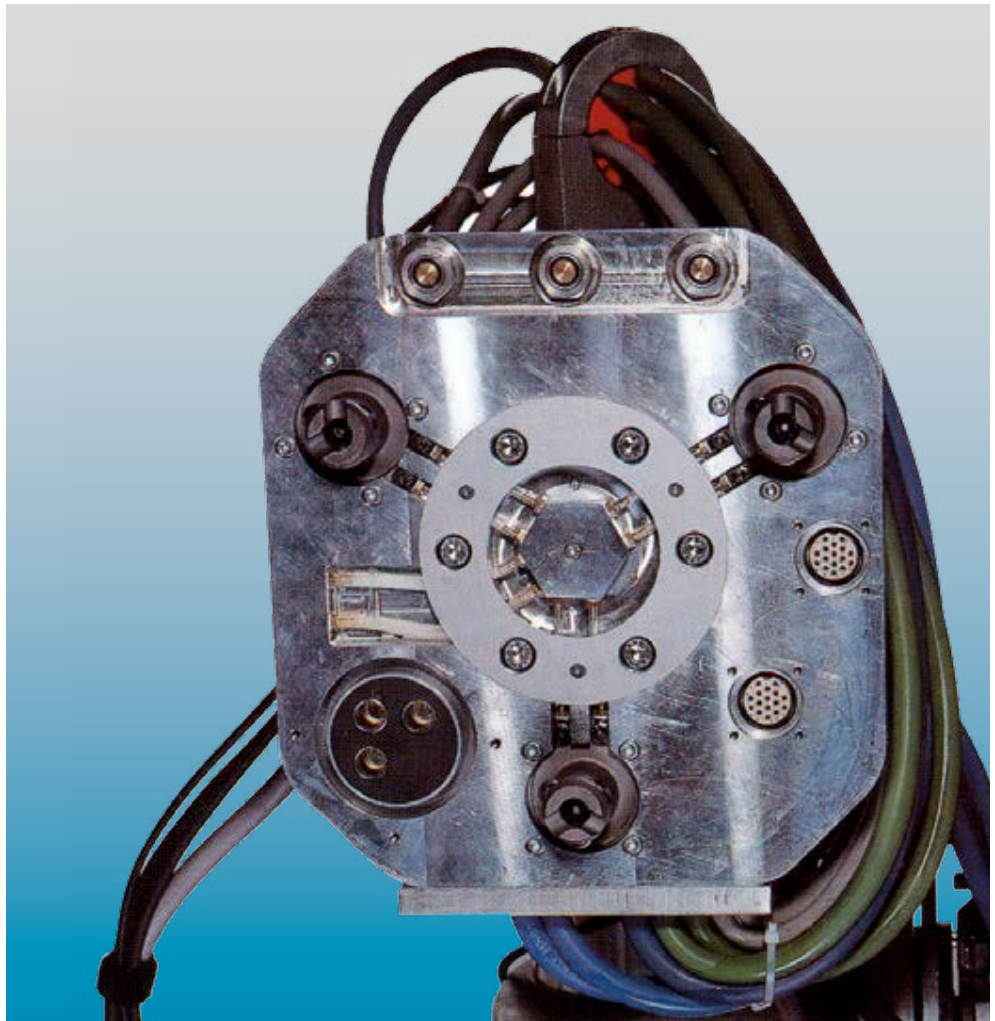
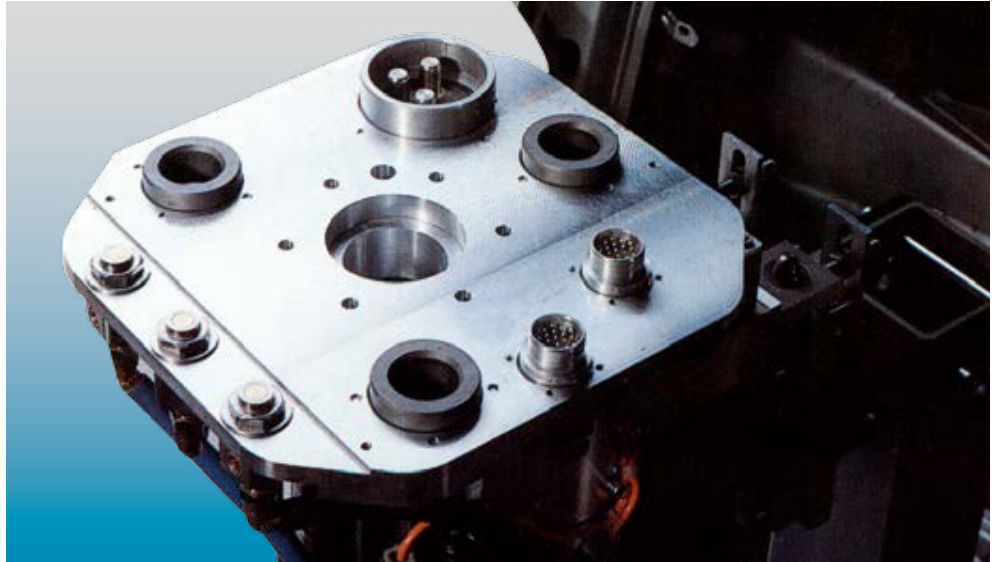

Advantages of the ODU DOCK Connectors



- Easy assembly
- Temperature range: -40° C up to +100° C
- Robust housing made out of aluminium or plastic
- Housing with EMC protection available
- 3 sizes
- Contacts with crimp and solder termination available
- Exchange of crimp contact within a few seconds
- Positions: 2 + PE up to 36 + PE, mixed inserts, power inserts
- Protection class: up to IP 65 available
- Straight and right-angled cable exit possible

- High contact reliability due to the established ODU SPRINGTAC contacts
- High number of mating cycles – up to 100,000
- Versions with quick-change head available for mating cycles of more than 1 million
- Floating mounting on docking plates
- Easy assembly of the insulator – anti-rotation
- High density with small contact diameter (e.g. 31 x Ø 0.76 mm in size 1)
- High variety of contact inserts.

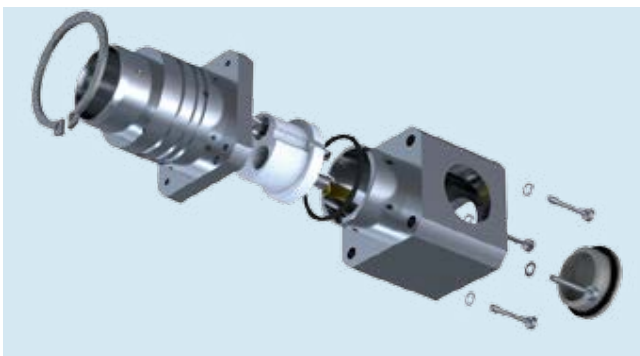

The ODU DOCK connection system consists of housing, insulator and contacts. These three components can be combined in a multitude of ways. In the crimp version, the contacts can be installed into and removed from the insulator in just a few seconds. The appropriate tools are available for this. In the solder version the contacts are permanently mounted in the insulator and cannot be removed.

Housing Versions for ODU DOCK

There are three housing versions available:

- Plastic housing
- Aluminium housing, nickel-plated
- Aluminium housing, black anodized.

Plastic housing

- Material: POM, black
- Protection class: IP 65 in mated condition
- Operating temperature: –40° C up to +100° C
- 3 housing sizes
- Easy assembly from rear of panel
- Straight and right-angled cable exit possible, sealing plug for unused cable exit is included in the delivery
- Two-part housing
- More than 100,000 mating cycles¹⁾

Aluminium housing, nickel-plated

- Material: aluminium, nickel-plated
- Protection class: IP 65 in mated condition (depends on version)
- Operating temperature: –40° C up to +100° C
- 3 housing sizes
- Easy assembly from rear of panel
- Straight and right-angled cable exit possible, sealing plug for unused cable exit is included in the delivery
- Two-part housing
- Available with and without EMC protection
- More than 100,000 mating cycles¹⁾

Aluminium housing, black anodized

- Material: aluminium, black anodized
- Protection class: IP 40
- Operating temperature: –40° C up to +100 °C
- 3 housing sizes
- Mountable from front of panel
- Straight and right-angled cable exit possible, sealing plug for unused cable exit is included in the delivery
- Two-part housing
- More than 100,000 mating cycles¹⁾



Plastic housing



Aluminium housing
nickel-plated



Aluminium housing
black anodized

¹⁾ Housing without shielding and without o-ring: min. 100,000 mating cycles.
Housing with shielding and without o-ring: min. 50,000 mating cycles.
It is recommended to change the front parts of the housing after 50,000 mating cycles, both socket and pin side.
Housing with o-ring: min. 25,000 mating cycles without maintenance and min. 100,000 mating cycles with maintenance.

Contact Inserts for ODU DOCK

Pin and socket inserts with crimp termination

The contact inserts consist of an insulator (contact carrier) and the associated number of pin or socket contacts. In the crimped model, the insulator and contacts must be ordered separately. This flexible design allows the contact insert to be equipped individually. Crimp contacts can be installed and removed very quickly.

Material

Insulator	PBT-GF (UL 94V-0)
Contacts	Cu-alloy surface contact from \varnothing 1.0 mm Au surface contact from \varnothing 1.5 mm Ag

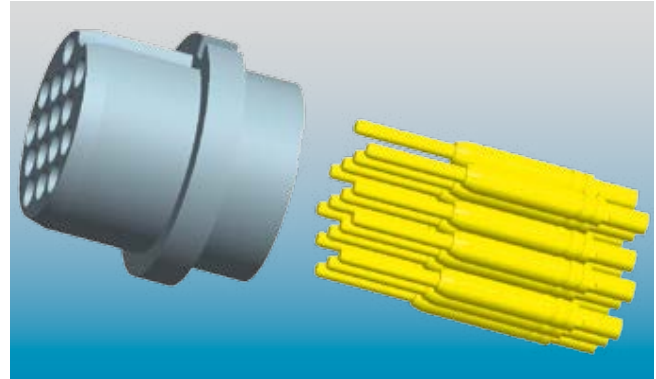

Pin and Socket inserts with solder termination

The contact inserts consist of an insulator (contact carrier) and the associated number of pin or socket contacts. Our solder inserts can cover a larger connection range. The contacts in the solder version are already mounted in the insulator, which means that the delivered contact insert is already completely equipped.

Material

Insulator	fibre-glass reinforced polyester resin (UL 94V-0)
Contacts	surface Ag

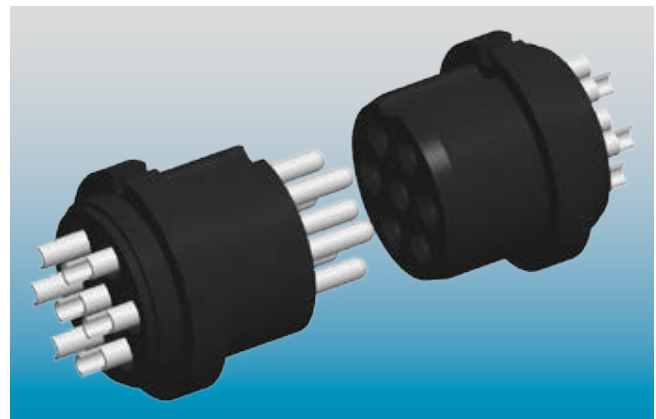

ODU SPRINGTAC® (Contacts with Springwire Technology)

The springwire contact is the inspired invention of Otto Dunkel. It offers the highest number of contact surfaces. The springwires are mounted individually and joined optimally to a turned carrier. The individual springwires contact and cushion independently of one another.

Advantages

- More than 100,000 mating cycles
- Low contact resistances
- Large number of independently cushioning contact springs
- Low insertion forces
- Extremely secure contacting
- High resistance to vibrations and impacts
- Long life span due to premium materials and surfaces.

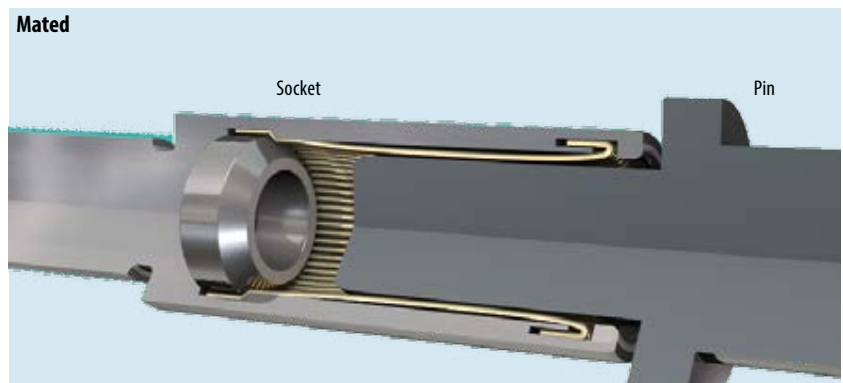
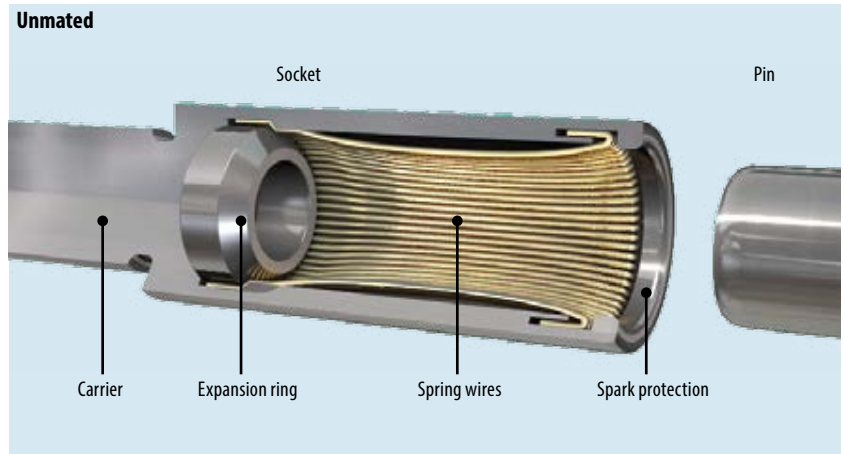

Inserts with Quick-Change Head Technology (QCH) for an extremely high number of mating cycles

Die ODU SPRINGTAC contacts offer contact stability for up to 100,000 mating cycles. The ODU DOCK quick-change head is suitable for applications that require even more mating cycles.

Principle behind the quick-change head

The connection system consists of an interchangeable front part (connector piece) and a back part (terminal piece). When the contacts suffer from wear, the front part is exchanged in a very short time without it being necessary to separate the connections that are made with the contacts of the back part.

Material

Insulator PBT-GF (UL 94V-0)
Contacts Cu-alloy

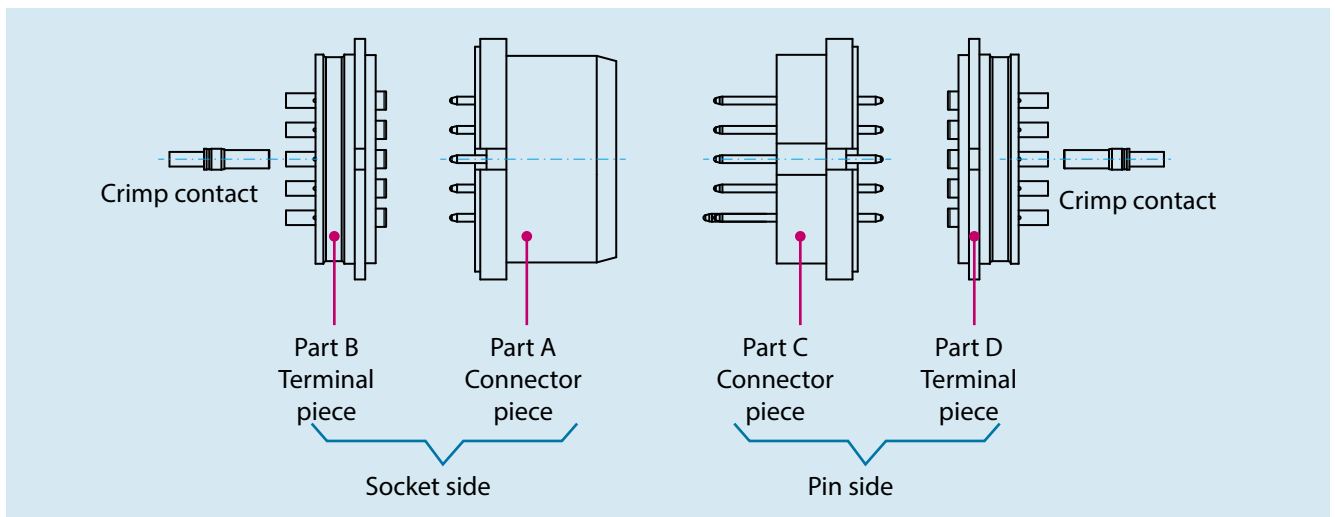

Terminal pieces stay wired.
Connector pieces are exchanged in the Docking System.
Contacts at the Terminal piece B and D are respectively crimp contacts.

Order Information ODU DOCK

Order example with crimp insert

Housing, insulator and contacts must be ordered separately when crimp contacts are used.

- ODU DOCK, size 2
- Housing: Aluminium, black anodized
- 6 positions with earthing pin.

	Socket piece	Pin piece
Housing	1 × 656.162.051.000.000	1 × 656.162.052.000.000
Cable clamp	1 × 027.825.090.170.007	1 × 027.825.090.170.007
Insulator	1 × 208.703.004.007.000	1 × 208.803.004.007.000
Contacts	7 × 170.382.000.201.000	6 × 180.334.000.301.000
Earthing contact		1 × 180.335.000.301.000



Picture for example only.

Order example with solder insert

Housing and insert must be ordered separately when the solder version is used. The contacts are already fixed in the insulator and don't need to be ordered separately.

- ODU DOCK, size 1
- Housing: aluminium, black anodized
- 4 positions.

	Socket part	Pin part
Housing	1 × 656.164.051.000.000	1 × 656.164.052.000.000
Cable clamp	1 × 027.820.070.130.007	1 × 027.820.070.130.007
Insert	1 × 656.164.702.150.004	1 × 656.164.802.150.004



Picture for example only.

Order example with flexible insert

With the flexible inserts, the housing, insulator and the flexibly interchangeable modules must be ordered separately. The insulator must be completely filled with modules.

- ODU DOCK, size 3
- Housing: aluminium, black anodized
- 2 × power modules from the ODU-MAC program for AWG 14.

	Socket part	Pin part
Housing	1 × 656.163.051.000.000	1 × 656.163.052.000.000
Cable clamp	1 × 027.832.070.150.007	1 × 027.832.070.150.007
Flexible insert	1 × 209.610.000.000.000	1 × 209.611.000.000.000
ODU-MAC modules*	2 × 610.162.103.923.000	2 × 611.162.103.923.000
Contacts*	6 × 172.582.100.201.000	6 × 182.582.000.301.000

* Order information and technical data see from [page 59](#), as well as the ODU-MAC product catalogue.

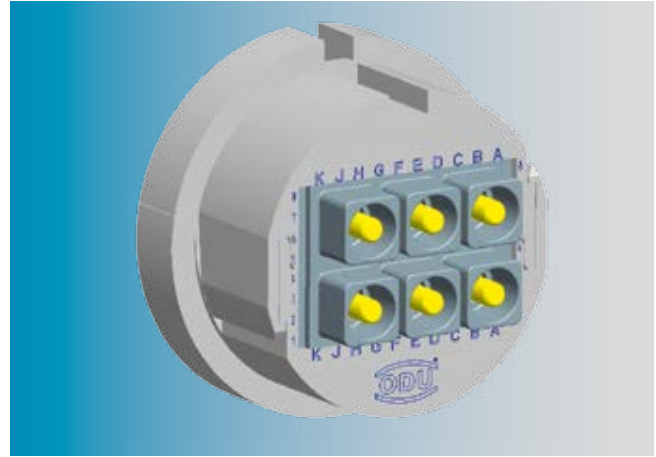

Order example for the quick-change head

The housing and inserts must be ordered separately for the quick-change head version.

The contacts for the inserts are included in the delivery.

- ODU DOCK QCH, size 3
- Housing: plastic
- 36 positions with earthing pin.

	Socket part	Pin part
Housing	1 × 656.163.011.000.000	1 × 656.163.012.000.000
Cable clamp	1 × 027.832.070.150.007	1 × 027.832.070.150.007
Insert QCH	A 1 × 252.058.001.037.000	C 1 × 252.059.001.037.000
	B 1 × 252.061.001.037.000	D 1 × 252.061.002.037.000

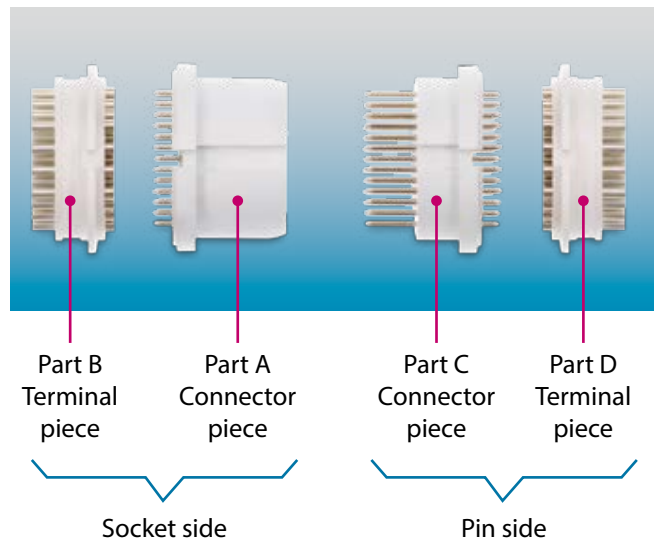



ODU DOCK Size 1

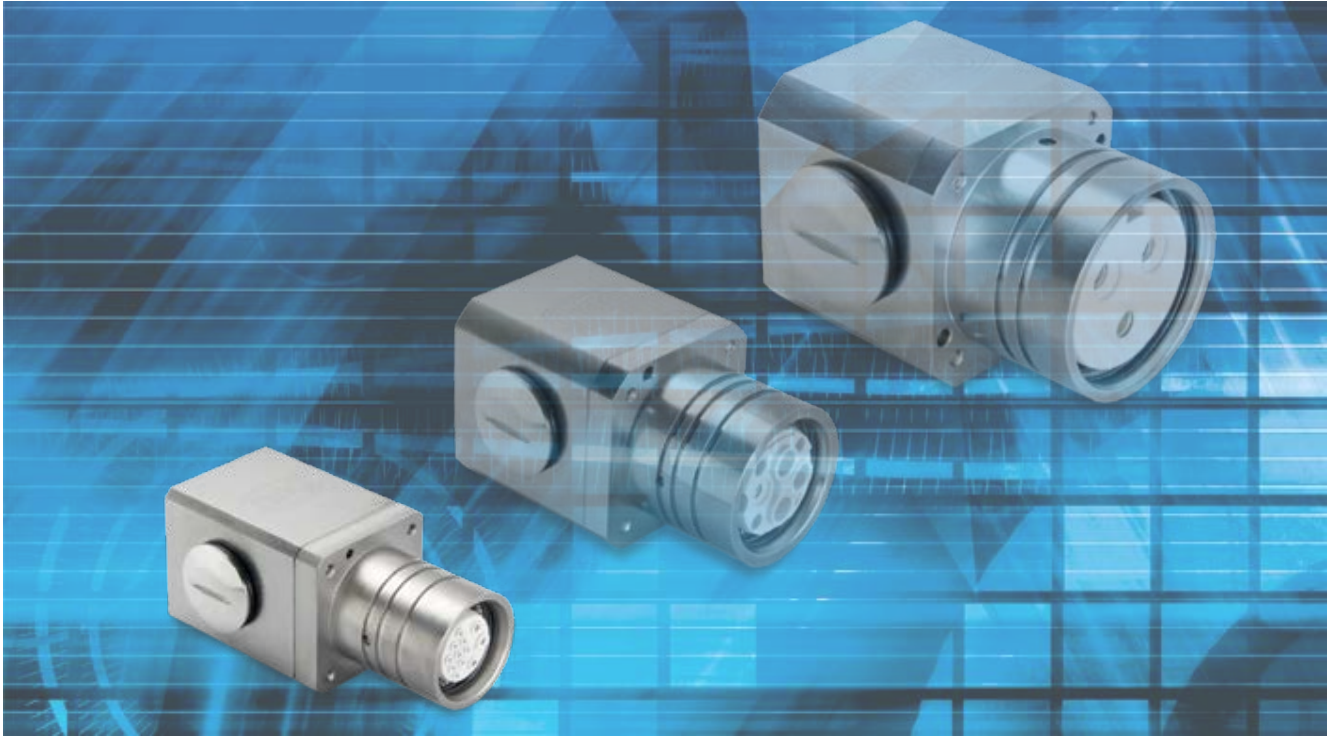

ODU DOCK
Size 1



Housing

Plastic



- Material: POM, black
- Protection class: IP 65 in mated condition
- Operating temperature: -40°C up to +100°C
- Easy assembly from rear of panel
- Straight and right-angled cable exit possible, sealing plug for unused cable exit is included in the delivery
- Two-part housing

Description	Part number			
Socket piece	656.164.011.000.000			
Pin piece	656.164.012.000.000			

Socket piece

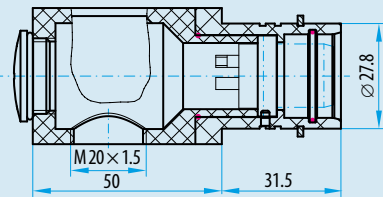

Pin piece

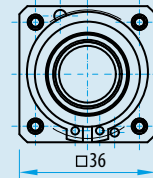
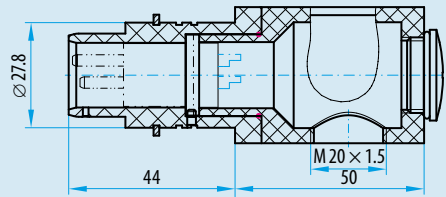

Aluminium, nickel-plated

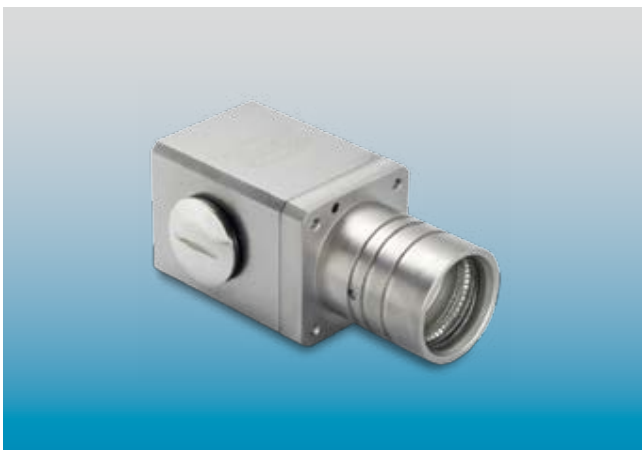

- Material: aluminium, nickel-plated
- Protection class: IP 65 in mated condition (depends on version)
- Operating temperature: -40°C up to +100°C
- Easy assembly from rear of panel
- Straight and right-angled cable exit possible, sealing plug for unused cable exit is included in the delivery
- Two-part housing
- Available with and without EMC protection

Description	Part number	IP 40	IP 65	EMC protection
Socket piece	656.164.021.000.000		•	•
	656.164.023.000.000	•		
	656.164.024.000.000	•		•
	656.164.025.000.000		•	
Pin piece	656.164.022.000.000	•	•	•

Socket piece

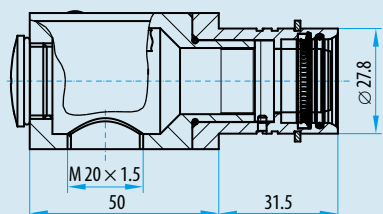

Pin piece

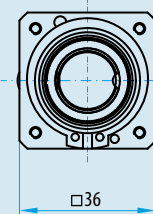
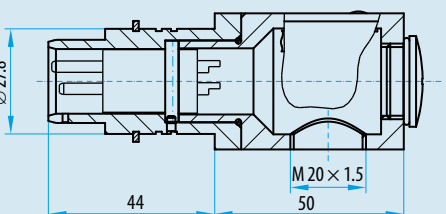

Aluminium, black anodized



- Material: aluminium, black-anodized
- Protection class: IP 40 in mated condition
- Operating temperature: -40°C up to +100°C
- Mountable from front of panel
- Straight and right-angled cable exit possible, sealing plug for unused cable exit is included in the delivery
- Two-part housing

Description	Part number	Thread X
Socket piece	656.164.051.000.000	M 20 × 1.5
	656.164.001.000.000	PG 16
Pin piece	656.164.052.000.000	M 20 × 1.5
	656.164.002.000.000	PG 16

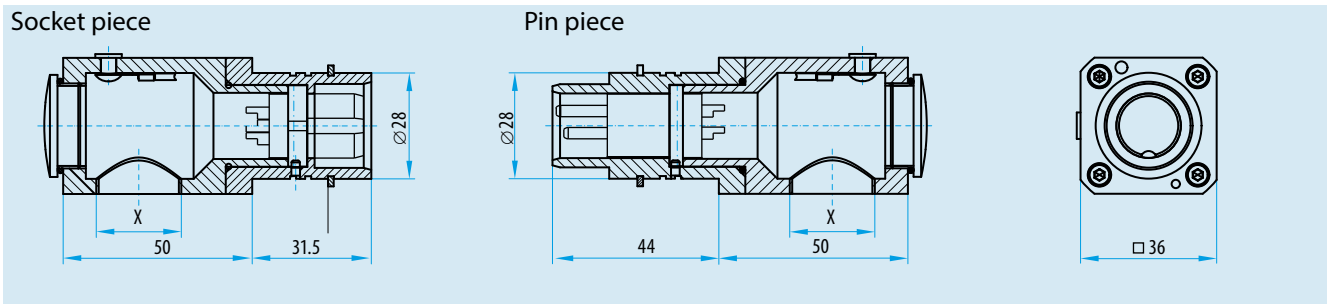

Assembly drilling for all size 1 versions

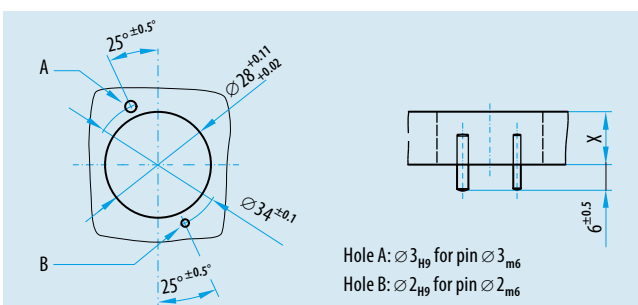

Board spacing
in mated position:
 $61 \pm 0.5 \text{ mm}$

Board thickness "X"
20 mm: ± 0.1
14 mm: ± 0.1
10 mm: ± 0.1

Pin and Socket Inserts with Crimp Termination

2 positions with earthing

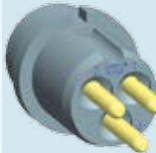
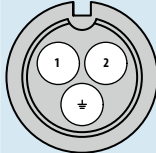
Socket	Pin	Contact configuration Socket View on the mating side	Description	Part number	Current in A nominal single contact current load	Contact diameter in mm	Termination cross-section in mm ²	Mating force in N	Demating force in N
			Insulator socket	207.703.004.003.000					
			Insulator pin	207.803.004.003.000					
			Sealing plug	021.341.136.304.000					
			Socket contact	170.382.000.201.000	30	3.0	2.5	31 ± 10	29 ± 10
			Pin contact	180.334.000.301.000					
			Earthing pin contact	180.335.000.301.000	25	3.0	1.5	31 ± 10	
			Socket contact	170.499.100.201.000					
			Pin contact	180.374.000.301.000					
			Earthing pin contact	180.375.000.301.000					



Voltage information acc. DIN EN*)	Metal housing		Plastic housing	
	500V	200V	630V	250V
Rated voltage	500V	200V	630V	250V
Rated impulse voltage	3 kV		4 kV	
Pollution degree	2	3	2	3

Crimping tools from page 73.
*DIN EN 60664-1 (VDE 0110-1) : 2008-01

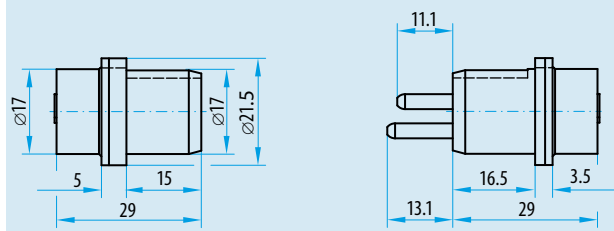
Dimensions insulator (socket piece/pin piece)

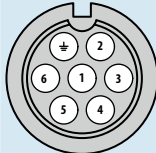

6 positions with earthing

Socket	Pin	Contact configuration Socket View on the mating side	Description	Part number	Current in A nominal single contact current load	Contact diameter in mm	Termination cross-section in mm ²	Mating force in N	Demating force in N
			Insulator socket	207.702.004.007.000					
			Insulator pin	207.802.004.007.000					
			Sealing plug	021.341.135.923.000					
			Socket contact	170.381.000.201.000	25	2.0	1.5	40 ± 13	37 ± 13
			Pin contact	180.332.000.301.000					
			Earthing pin contact	180.333.000.301.000	20	2.0	1.0	40 ± 13	
			Socket contact	170.827.100.201.000					
			Pin contact	180.827.000.301.000					
			Earthing pin contact	180.828.000.301.000					



Voltage information acc. DIN EN*)	Metal housing		Plastic housing	
	500V	160V	500V	200V
Rated voltage	500V	160V	500V	200V
Rated impulse voltage	3 kV		3 kV	
Pollution degree	2	3	2	3

Crimping tools from page 73.
*DIN EN 60664-1 (VDE 0110-1) : 2008-01

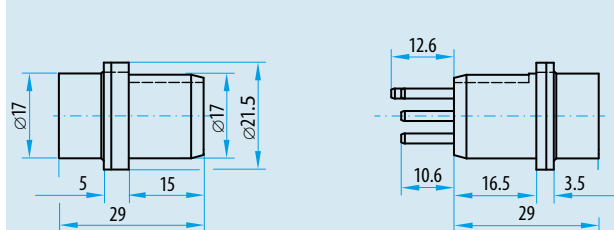
Dimensions insulator (socket piece/pin piece)

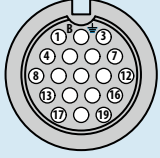

18 positions with earthing

Socket	Pin	Contact configuration Socket View on the mating side	Description	Part number	Current in A nominal single contact current load	Contact diameter in mm	Termination cross- section in mm ²	Mating force in N	Demating force in N
			Insulator socket Insulator pin Sealing plug Socket contact Pin contact	207.701.001.019.000 207.801.001.019.000 021.341.124.300.000 170.362.700.207.000 182.970.000.307.000	12	1.02	0.38 0.50	20 ± 7	18 ± 6

Voltage information acc. DIN EN*)	Metal housing		Plastic housing	
	400V	160V	630V	250V
Rated voltage	400V	160V	630V	250V
Rated impulse voltage	2.5 kV		3 kV	
Pollution degree	2	3	2	3



No extra earth contact necessary. Earthing is provided via the insulator geometry.
Crimping tools from [page 73](#).

*DIN EN 60664-1 (VDE 0110-1) : 2008-01

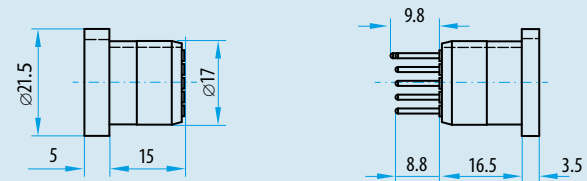
Dimensions insulator (socket piece/pin piece)

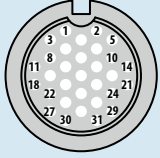

31 positions

Socket	Pin	Contact configuration Socket View on the mating side	Description	Part number	Current in A nominal single contact current load	Contact diameter in mm	Termination cross- section in mm ²	Mating force in N	Demating force in N
			Insulator socket Insulator pin Sealing plug Socket contact Pin contact	207.742.001.031.000 207.842.001.031.000 021.341.123.923.000 170.361.700.207.000 180.381.000.307.000	10	0.76	0.38	30 ± 10	28 ± 10
			Socket contact Pin contact	170.540.700.207.000 180.570.000.307.000	8	0.76	0.08 0.25	30 ± 10	

Voltage information acc. DIN EN*)	Metal housing		Plastic housing	
	250V	50V	320V	80V
Rated voltage	250V	50V	320V	80V
Rated impulse voltage	2 kV		2.5 kV	
Pollution degree	2	3	2	3

Without earthing contact. Crimping tools from [page 73](#).

*DIN EN 60664-1 (VDE 0110-1) : 2008-01

Dimensions insulator (socket piece/pin piece)

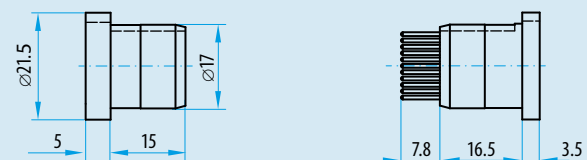

Pin- and Socket Inserts with Crimp Termination

2 positions with earthing and 9 pilot contacts

Socket	Pin	Contact configuration Socket View on the mating side	Description	Part number	Current in A nominal single contact current load	Contact diameter in mm	Termination cross-section in mm ²	Mating force in N	Demating force in N
			Insulator socket	207.700.001.012.000					
			Insulator pin	207.800.001.012.000					
			Sealing plug	021.341.125.923.000		1.5			
			Sealing plug	021.341.124.300.000		1.02			
			Socket contact (10, 11, E)	170.363.100.201.001	25	1.5	1.5	20 ± 7	18 ± 6
			Socket contact (1 to 9)	170.362.700.207.000	12	1.02	0.38/0.5		
			Pin contact (10, 11, E)	180.383.000.301.000	25	1.5	1.5		
			Pin contact (1 to 9)	180.382.000.307.000	12	1.02	0.38/0.5		

Voltage information acc. DIN EN*)	Metal housing		Plastic housing	
for contact diameter 1.5				
Rated voltage	630 V	250 V	800 V	320 V
Rated impulse voltage	3 kV		4 kV	
Pollution degree	2	3	2	3
for contact diameter 1.02				
Rated voltage	400 V	160 V	630 V	250 V
Rated impulse voltage	2.5 kV		3 kV	
Pollution degree	2	3	2	3

Dimensions insulator (socket piece/pin piece)

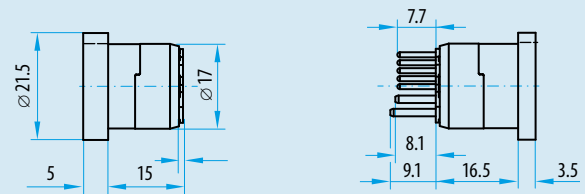



No extra earth contact necessary. Earthing is provided via the insulator geometry.

Crimping tools from [page 73](#).

*DIN EN 60664-1 (VDE 0110-1) : 2008-01

Pin and Socket Inserts with Solder Termination

2 positions

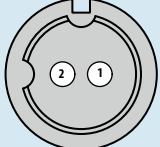
Socket	Pin	Contact configuration Socket View on the mating side	Description	Part number	Current in A nominal single contact current load	Contact diameter in mm	Termination cross-section in mm ²	Mating force in N	Demating force in N
			Socket insert Pin insert	656.164.745.751.002 656.164.845.751.002	25	1.5	2.5	10 ± 3	8 ± 3



Voltage information acc. DIN EN*)	Metal housing		Plastic housing	
	400 V	160 V	400 V	160 V
Rated voltage	400 V	160 V	400 V	160 V
Rated impulse voltage	3 kV		3 kV	
Pollution degree	2	3	2	3

*DIN EN 60664-1 (VDE 0110-1) : 2008-01

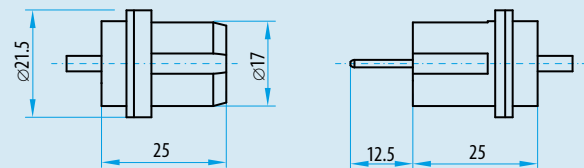
Dimensions insulator (socket piece/pin piece)

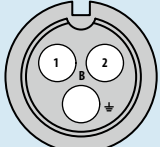

2 positions with earthing

Socket	Pin	Contact configuration Socket View on the mating side	Description	Part number	Current in A nominal single contact current load	Contact diameter in mm	Termination cross-section in mm ²	Mating force in N	Demating force in N
			Socket insert Pin insert	656.164.703.152.003 656.164.803.152.003	30	3.0	2.5	30 ± 10	25 ± 8

Voltage information acc. DIN EN*)	Metal housing		Plastic housing	
	630 V	200 V	630 V	200 V
Rated voltage	630 V	200 V	630 V	200 V
Rated impulse voltage	4 kV		4 kV	
Pollution degree	2	3	2	3



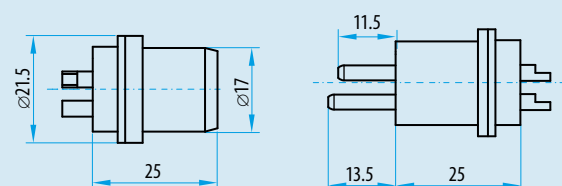

*DIN EN 60664-1 (VDE 0110-1) : 2008-01

Dimensions insulator (socket piece/pin piece)

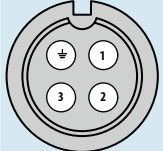

Pin and Socket Inserts with Solder Termination

3 positions with earthing / 4 positions with earthing

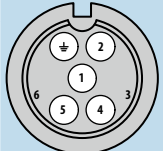
Socket	Pin	Contact configuration Socket View on the mating side	Description	Part number	Current in A nominal single contact current load	Contact diameter in mm	Termination cross-section in mm ²	Mating force in N	Demating force in N
			Socket insert Pin insert	656.164.702.150.004 656.164.802.150.004	30	2.0	2.5	25 ± 8	20 ± 7
			Socket insert Pin insert	656.164.702.150.005 656.164.802.150.005	25	2.0	1.5	30 ± 10	25 ± 8



Voltage information acc. DIN EN*)	Metal housing		Plastic housing	
	500 V	200 V	500 V	200 V
Rated voltage	500 V	200 V	500 V	200 V
Rated impulse voltage	3 kV		3 kV	
Pollution degree	2	3	2	3

*DIN EN 60664-1 (VDE 0110-1) : 2008-01

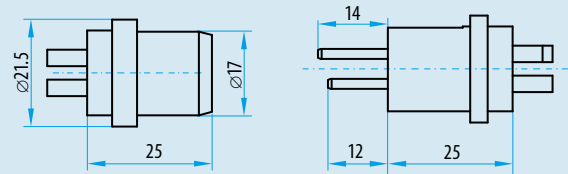
Dimensions insulator (socket piece/pin piece)

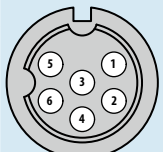

6 positions

Socket	Pin	Contact configuration Socket View on the mating side	Description	Part number	Current in A nominal single contact current load	Contact diameter in mm	Termination cross-section in mm ²	Mating force in N	Demating force in N
			Socket insert Pin insert	656.164.745.751.006 656.164.845.751.006	25	1.5	2.5	25 ± 8	20 ± 7



Voltage information acc. DIN EN*)	Metal housing		Plastic housing	
	800 V	250 V	1,000 V	250 V
Rated voltage	800 V	250 V	1,000 V	250 V
Rated impulse voltage	3 kV		3 kV	
Pollution degree	2	3	2	3

*DIN EN 60664-1 (VDE 0110-1) : 2008-01

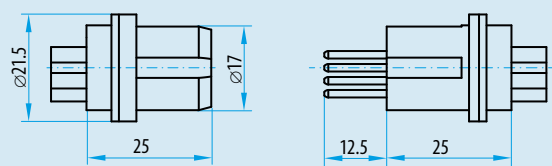
Dimensions insulator (socket piece/pin piece)

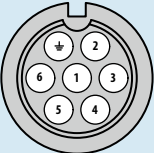

6 positions with earthing

Socket	Pin	Contact configuration Socket View on the mating side	Description	Part number	Current in A nominal single contact current load	Contact diameter in mm	Termination cross-section in mm ²	Mating force in N	Demating force in N
			Socket insert Pin insert	656.164.702.150.007 656.164.802.150.007	25	2.0	1.5	40 ± 12	30 ± 10



Voltage information acc. DIN EN*)	Metal housing		Plastic housing	
	500 V	200 V	500 V	200 V
Rated voltage	500 V	200 V	500 V	200 V
Rated impulse voltage	3 kV		3 kV	
Pollution degree	2	3	2	3

*DIN EN 60664-1 (VDE 0110-1) : 2008-01

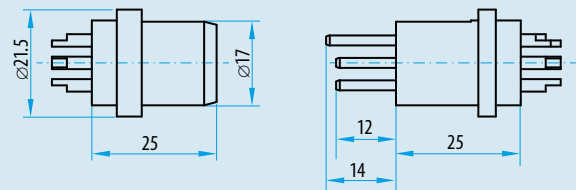
Dimensions insulator (socket piece/pin piece)

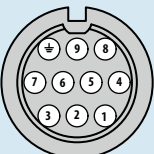

9 positions with earthing

Socket	Pin	Contact configuration Socket View on the mating side	Description	Part number	Current in A nominal single contact current load	Contact diameter in mm	Termination cross-section in mm ²	Mating force in N	Demating force in N
			Socket insert Pin insert	656.164.701.150.010 656.164.801.150.010	12	1.0	1.0	20 ± 7	18 ± 6

Voltage information acc. DIN EN*)	Metal housing		Plastic housing	
	250 V	32 V	320 V	63 V
Rated voltage	250 V	32 V	320 V	63 V
Rated impulse voltage	2 kV		2.5 kV	
Pollution degree	2	3	2	3

*DIN EN 60664-1 (VDE 0110-1) : 2008-01

Dimensions insulator (socket piece/pin piece)

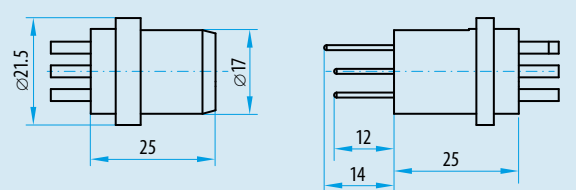

Quick-Change Head System (QCH) with Crimp Termination

6 positions with grounding / 18 positions with grounding

Socket	Pin	Contact configuration Socket View on the mating side	Description	Part number	Current in A nominal single contact current load	Contact diameter X in mm	Termination diameter Y in mm	Termination cross- section in mm ²	Mating force in N	Demating force in N
			Insulator part A	252.087.001.007.000	18	2.0	1.5	0.5 to 1.5	40 ± 13	37 ± 13
			Insulator part B	252.089.001.007.000						
			Insulator part C	252.088.001.007.000						
			Insulator part D	252.089.002.007.000						
			Insulator part A	252.087.001.019.000	12	1.0	0.9	0.5 to 1.0	20 ± 7	18 ± 16
			Insulator part B	252.089.011.019.000						
			Insulator part C	252.088.001.019.000						
			Insulator part D	252.089.012.019.000						

Crimping tools from [page 73](#).

Operating voltage in the metal housing: 50V / 2.5 kV / 3

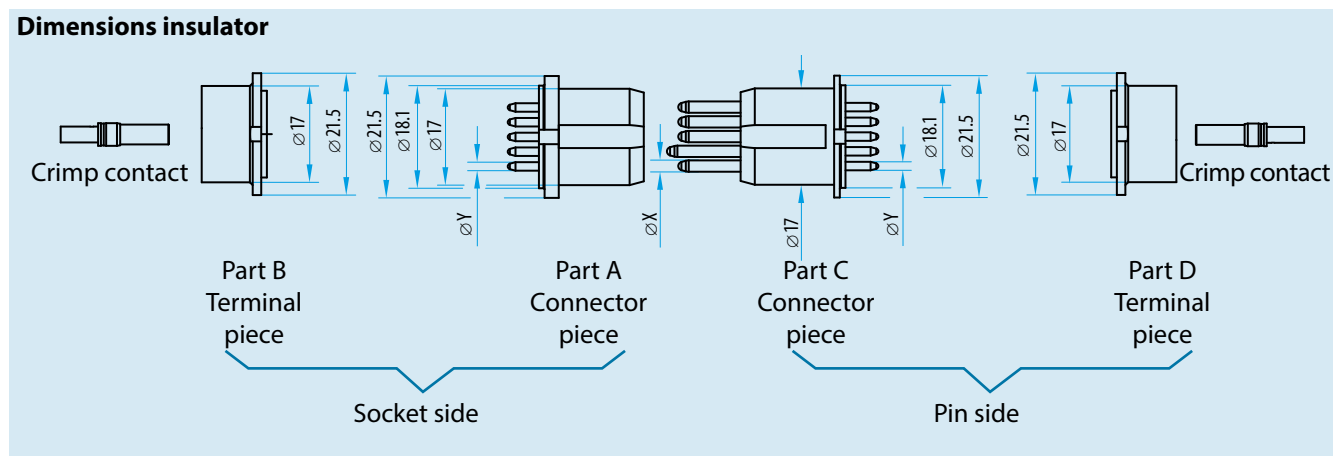

Terminal pieces stay wired.

Connector pieces are exchanged in the Docking System.

Contacts at the Terminal piece B and D are respectively crimp contacts.

Current Carrying Capacity for Fully Equipped Inserts (Excerpt)

Derating curves for crimp inserts

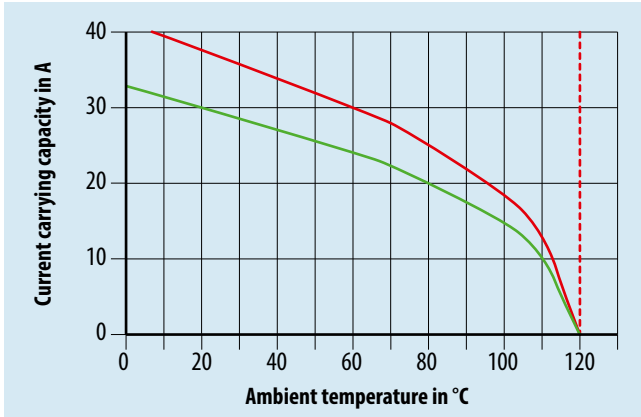

Insert 207.703.004.003.000 with 207.803.004.003.000 equipped with contact diameter 3.0 mm (cable cross-section 2.5 mm²).

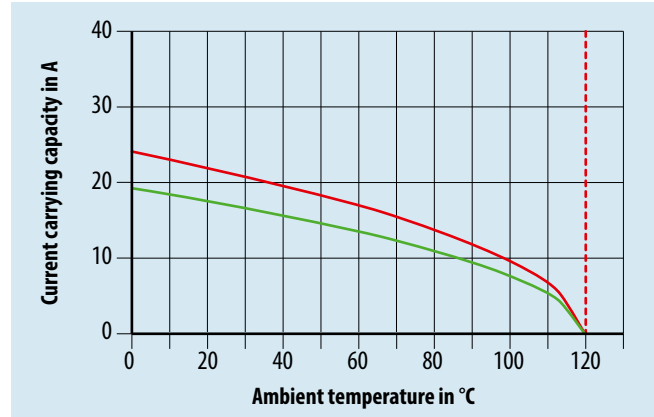

Insert 207.702.004.007.000 with 207.802.004.007.000 equipped with contact diameter 2.0 mm (cable cross section 1.5 mm²).

Derating curves for crimp inserts

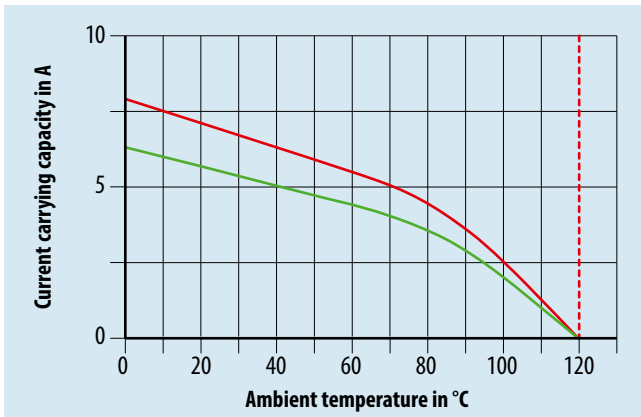

Insert 207.701.001.019.000 with 207.801.001.019.000 equipped with contact diameter 1.02 mm (cable cross-section 0.50 mm²).

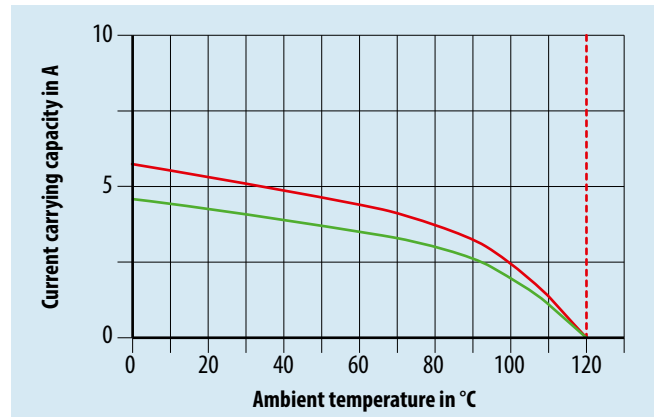

Insert 207.742.001.031.000 with 207.842.001.031.000 equipped with contact diameter 0.76 mm (cable cross-section 0.38 mm²).

Legend of diagrams

- - - Max. temperature of contact material
- Basis curve
- Corrected curve

Further derating curves see next page.

Current Carrying Capacity for Fully Equipped Inserts (Excerpt)

Derating curves for crimp inserts with mixed insert

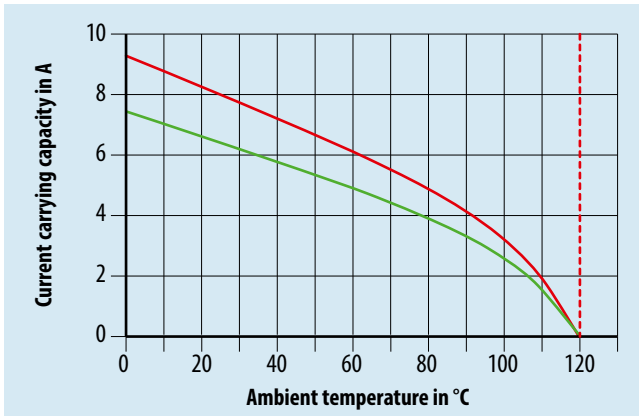

Contact diameter **1.02 mm**

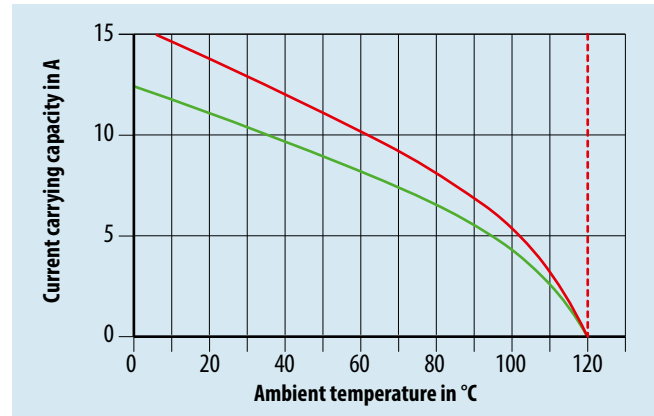

Contact diameter **1.5 mm**

Mixed insert: Insert 207.700.001.012.000 with 207.800.001.012.000 equipped with contact diameter 1.5 mm (cable cross-section 1.5 mm²) and contact diameter 1.02 mm (cable cross-section 0.50 mm²).

Derating curve for quick-change head system

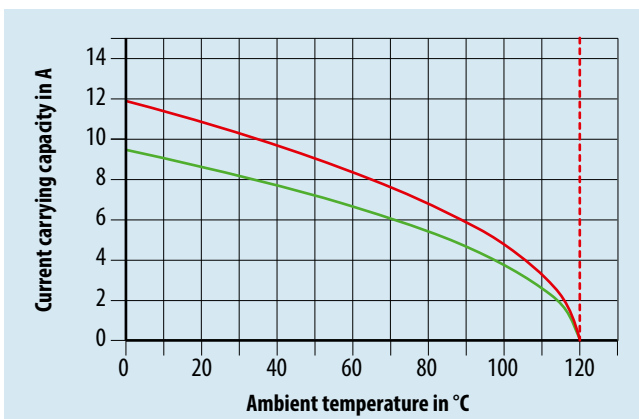

Insert 252.087.001.019.000 / 252.089.011.019.000 with 252.088.001.019.000 / 252.089.012.019.000 equipped with contact diameter 1.0 mm (cable cross-section 1 mm²).

Legend of diagrams

- - - Max. temperature of contact material
- Basis curve
- Corrected curve

Further derating curves on request.





ODU DOCK Size 2

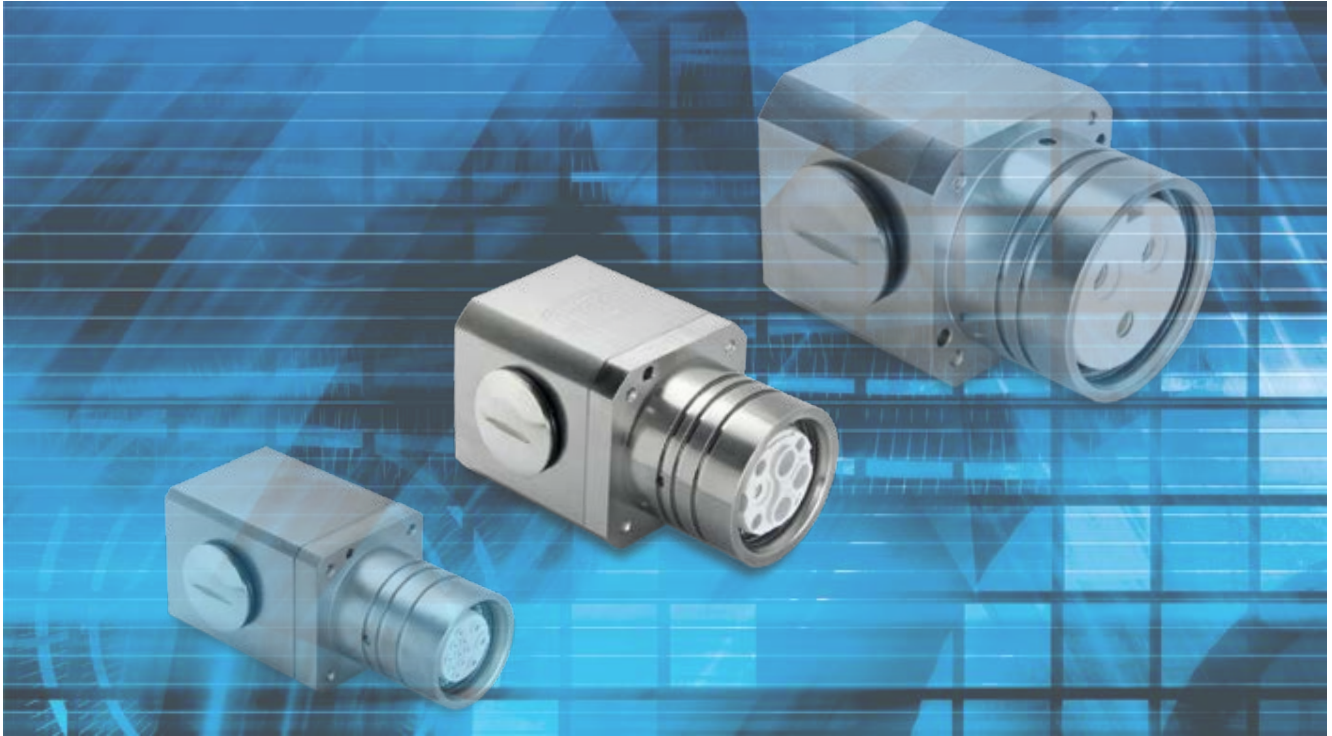

ODU DOCK
Size 2



Housing

Plastic



- Material: POM, black
- Protection class: IP 65 in mated condition
- Operating temperature: -40°C up to +100°C
- Easy Assembly from rear of panel
- Straight and right-angled cable exit possible, sealing plug for unused cable exit is included in the delivery
- Two-part housing

Description	Part number			
Socket piece	656.162.011.000.000			
Pin piece	656.162.012.000.000			

Socket piece

Pin piece

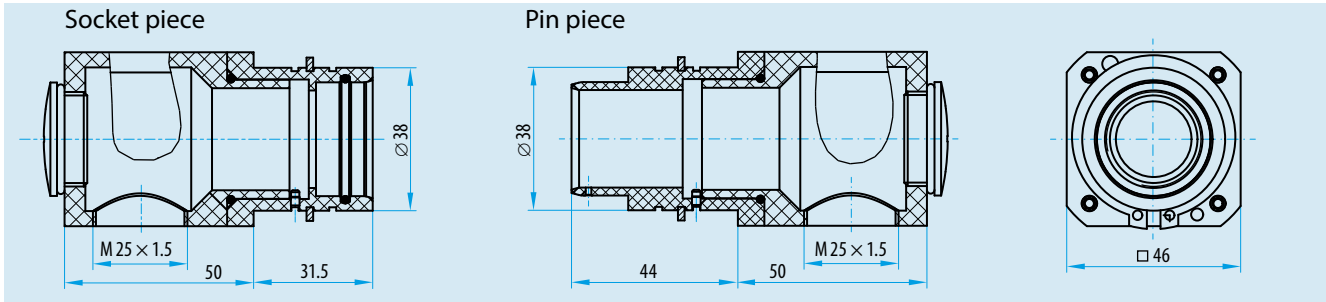

Aluminium, nickel-plated



- Material: aluminium, nickel-plated
- Protection class: IP 65 in mated condition (depends on version)
- Operating temperature: -40°C up to +100°C
- Easy Assembly from rear of panel
- Straight and right-angled cable exit possible, sealing plug for unused cable exit is included in the delivery
- Two-part housing
- Available with and without EMC protection

Description	Part number	IP 40	IP 65	EMC protection
Socket piece	656.162.021.000.000		•	•
	656.162.023.000.000	•		
	656.162.024.000.000	•		•
	656.162.025.000.000		•	
Pin piece	656.162.022.000.000	•	•	•

Socket piece

Pin piece

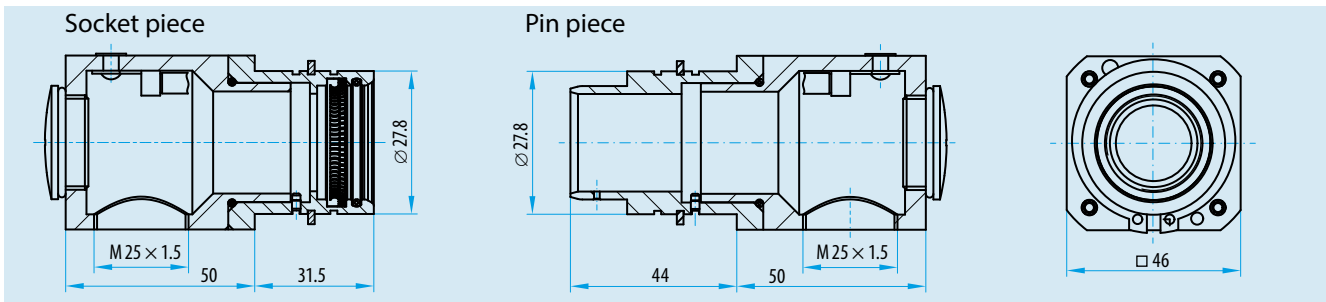

Aluminium, black anodized



- Material: aluminium, black anodized
- Protection class: IP 40
- Operating temperature: -40°C up to +100°C
- Mountable from front of panel
- Straight and right-angled cable exit possible, sealing plug for unused cable exit is included in the delivery
- Two-part housing

Description	Part number	Thread X
Socket piece	656.162.051.000.000	M 25 × 1.5
	656.162.001.000.000	PG 21
Pin piece	656.162.052.000.000	M 25 × 1.5
	656.162.002.000.000	PG 21

ODU DOCK
Size 2

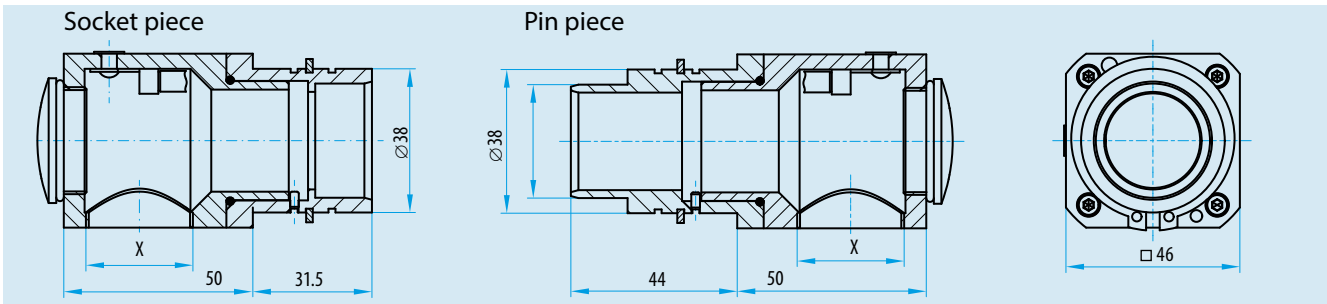

Assembly drilling for all size 2 versions

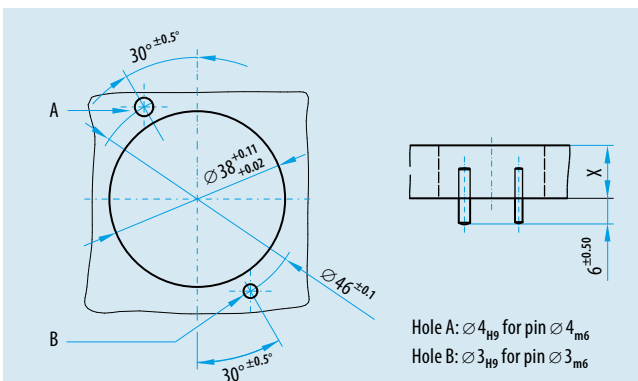

Board spacing
in mated condition:
 61 ± 0.5 mm

Board thickness "X"
20 mm: ± 0.1
14 mm: ± 0.1
10 mm: ± 0.1

Pin and Socket Inserts with Crimp Termination

4 positions with earthing / 6 positions with earthing

Socket	Pin	Contact configuration Socket View on the mating side	Description	Part number	Current in A nominal single contact current load	Contact diameter in mm	Termination cross- section in mm ²	Mating force in N	Demating force in N
			Insulator socket	208.703.004.005.000	30	3.0	2.5	50 ± 15	45 ± 15
			Insulator pin	208.803.004.005.000					
			Sealing plug	021.341.136.304.000					
		Socket contact	170.382.000.201.000	25	3.0	1.5	70 ± 20	60 ± 20	
		Pin contact	180.334.000.301.000						
		Earthing pin contact	180.335.000.301.000						
			Insulator socket	208.703.004.007.000	30	3.0	2.5	70 ± 20	60 ± 20
			Insulator pin	208.803.004.007.000					
			Sealing plug	021.341.136.304.000					
		Socket contact	170.382.000.201.000	25	3.0	1.5	70 ± 20	60 ± 20	
		Pin contact	180.334.000.301.000						
		Earthing pin contact	180.335.000.301.000						
Socket contact	170.499.100.201.000	25	3.0	1.5	70 ± 20	60 ± 20			
Pin contact	180.374.000.301.000								
Earthing pin contact	180.375.000.301.000								

ODU DOCK
Size 2

Voltage information acc. DIN EN*)	Metal housing		Plastic housing	
	800 V	320 V	800 V	320 V
Rated voltage	800 V	320 V	800 V	320 V
Rated impulse voltage	4 kV		4 kV	
Pollution degree	2	3	2	3

Crimping tools from [page 73](#).
 *) DIN EN 60664-1 (VDE 0110-1) : 2008-01

Dimensions insulator (socket piece/pin piece)

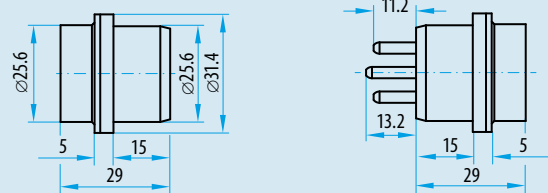

15 positions with earthing

Socket	Pin	Contact configuration Socket View on the mating side	Description	Part number	Current in A nominal single contact current load	Contact diameter in mm	Termination cross- section in mm ²	Mating force in N	Demating force in N
			Insulator socket	208.702.004.016.000					
			Insulator pin	208.802.004.016.000					
			Sealing plug	021.341.135.924.000					
			Socket contact	170.381.000.201.000	25	2.0	1.5	90 ± 30	80 ± 25
			Pin contact	180.332.000.301.000					
			Earthing pin contact	180.333.000.301.000	20	2.0	1.0		
			Socket contact	170.827.100.201.000					
			Pin contact	180.827.000.301.000					
			Earthing pin contact	180.828.000.301.000					

Voltage information acc. DIN EN*)	Metal housing		Plastic housing	
	400 V	160 V	400 V	160 V
Rated voltage	400 V	160 V	400 V	160 V
Rated impulse voltage	3 kV		3 kV	
Pollution degree	2	3	2	3

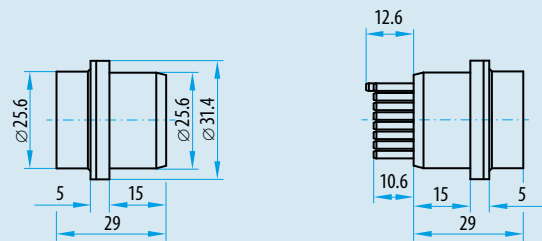

Crimping tools from [page 73](#).
 *)DIN EN 60664-1 (VDE 0110-1) : 2008-01

Dimensions insulator (socket piece/pin piece)



Pin and Socket Inserts with Crimp Termination

3 positions with earthing and 4 pilot contacts

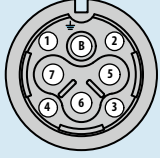
Socket	Pin	Contact configuration Socket View on the mating side	Description	Part number	Current in A nominal single contact current load	Contact diameter in mm	Termination cross-section in mm ²	Mating force in N	Demating force in N
			Insulator socket	208.700.001.008.000					
			Insulator pin	208.800.001.008.000					
			Sealing plug socket/pin	021.341.136.924.000		3.0			
			Sealing plug socket	021.341.131.923.000		1.5			
			Sealing plug pin	021.341.132.923.000		1.5			
			Socket contact	172.085.100.201.000	35	3.0	4	50 ± 15	45 ± 15
			Socket contact	170.363.100.201.001	25	1.5	1.5		
			Pin contact	182.085.000.301.000	35	3.0	4		
			Pin contact	181.135.000.301.000	25	1.5	1.5		
			Socket contact	170.382.000.201.000	30	3.0	2.5		
			Pin contact	180.335.000.301.000					
			Socket contact	170.499.100.201.000	25	3.0	1.5		
			Pin contact	180.375.000.301.000					

ODU DOCK
Size 2

Voltage information acc. DIN EN ^{*)}	Metal housing		Plastic housing	
	1600V	800V	1600V	800V
for contact diameter 3.0				
Rated voltage	1600V	800V	1600V	800V
Rated impulse voltage	6 kV		8 kV	
Pollution degree	2	3	2	3
for contact diameter 1.5				
Rated voltage	630V	250V	1600V	800V
Rated impulse voltage	4 kV		8 kV	
Pollution degree	2	3	2	3

Dimensions insulator (socket piece/pin piece)

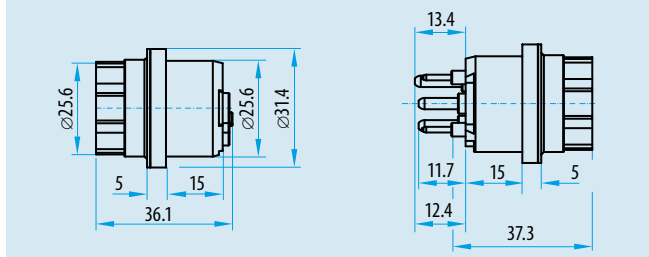

No extra earth contact necessary. Earthing is provided via the insulator geometry.

Crimping tools from [page 73](#).

^{*)}DIN EN 60664-1 (VDE 0110-1) : 2008-01

Pin and Socket Inserts with Solder Termination

2 positions with earthing

Socket	Pin	Contact configuration Socket View on the mating side	Description	Part number	Current in A nominal single contact current load	Contact diameter in mm	Termination cross-section in mm ²	Mating force in N	Demating force in N
			Socket insert Pin insert	656.162.705.150.003 656.162.805.150.003	85	5.0	10	50 ± 15	45 ± 15

Voltage information acc. DIN EN*)	Metal housing		Plastic housing	
	630 V	250 V	800 V	320 V
Rated voltage	630 V	250 V	800 V	320 V
Rated impulse voltage	4 kV		5 kV	
Pollution degree	2	3	2	3

*DIN EN 60664-1 (VDE 0110-1) : 2008-01

Dimensions insulator (socket piece/pin piece)

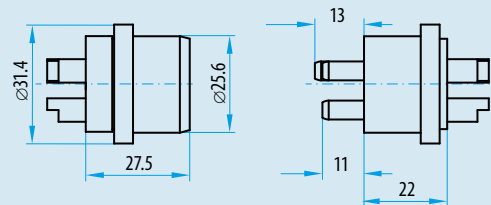

4 positions with earthing / 6 positions with earthing

Socket	Pin	Contact configuration Socket View on the mating side	Description	Part number	Current in A nominal single contact current load	Contact diameter in mm	Termination cross-section in mm ²	Mating force in N	Demating force in N
			Socket insert Pin insert	656.162.703.152.005 656.162.803.152.005	30	3.0	2.5	50 ± 15	45 ± 15
			Socket insert Pin insert	656.162.703.161.007 656.162.803.161.007	30	3.0	2.5	70 ± 20	60 ± 20

Voltage information acc. DIN EN*)	Metal housing		Plastic housing	
	630 V	250 V	800 V	250 V
Rated voltage	630 V	250 V	800 V	250 V
Rated impulse voltage	4 kV		4 kV	
Pollution degree	2	3	2	3

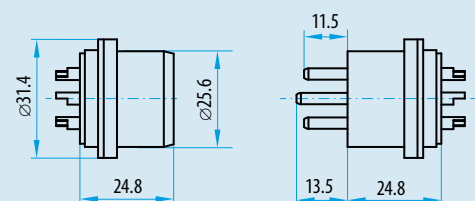

*DIN EN 60664-1 (VDE 0110-1) : 2008-01

Dimensions insulator (socket piece/pin piece)



Pin and Socket Inserts with Solder Termination

15 positions with earthing

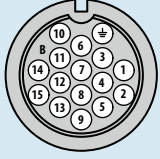
Socket	Pin	Contact configuration Socket View on the mating side	Description	Part number	Current in A nominal single contact current load	Contact diameter in mm	Termination cross-section in mm ²	Mating force in N	Demating force in N
			Socket insert Pin insert	656.162.702.153.016 656.162.802.152.016	25	2.0	1.5	90 ± 30	80 ± 25

Voltage information acc. DIN EN*)	Metal housing		Plastic housing	
	320 V	63 V	320 V	63 V
Rated voltage	320 V	63 V	320 V	63 V
Rated impulse voltage	2.5 kV		2.5 kV	
Pollution degree	2	3	2	3

*DIN EN 60664-1 (VDE 0110-1) : 2008-01

Dimensions insulator (socket piece/pin piece)

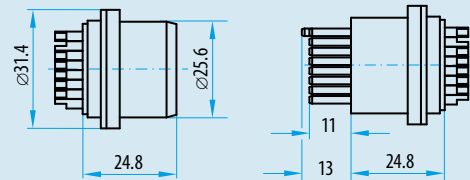

23 positions with earthing

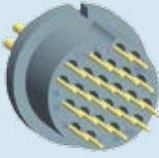
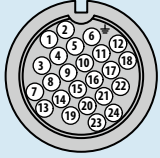
Socket	Pin	Contact configuration Socket View on the mating side	Description	Part number	Current in A nominal single contact current load	Contact diameter in mm	Termination cross-section in mm ²	Mating force in N	Demating force in N
			Socket insert Pin insert	656.162.701.150.024 656.162.801.150.024	12	1.0	1.5	35 ± 12	30 ± 10



Voltage information acc. DIN EN*)	Metal housing		Plastic housing	
	320 V	63 V	320 V	63 V
Rated voltage	320 V	63 V	320 V	63 V
Rated impulse voltage	2.5 kV		2.5 kV	
Pollution degree	2	3	2	3

*DIN EN 60664-1 (VDE 0110-1) : 2008-01

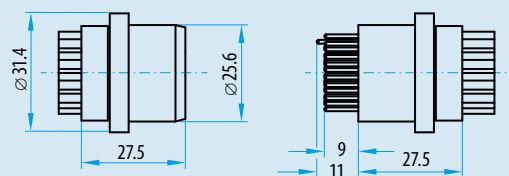
Dimensions insulator (socket piece/pin piece)

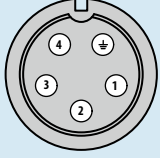

4 positions with earthing

Socket	Pin	Contact configuration Socket View on the mating side	Description	Part number	Current in A nominal single contact current load	Contact diameter in mm	Termination cross-section in mm ²	Mating force in N	Demating force in N
			Socket insert Pin insert	656.162.704.150.005 656.162.804.150.005	55	4.0	6.0	60 ± 20	50 ± 15

Voltage information acc. DIN EN*)	Metal housing		Plastic housing	
	400 V	160 V	400 V	160 V
Rated voltage	400 V	160 V	400 V	160 V
Rated impulse voltage	2.5 kV		2.5 kV	
Pollution degree	2	3	2	3

*DIN EN 60664-1 (VDE 0110-1) : 2008-01

Dimensions insulator (socket piece/pin piece)

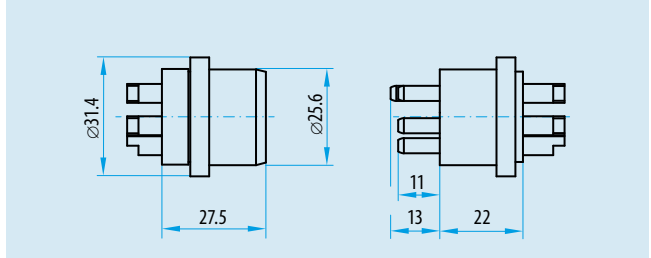

Quick-Change Head System (QCH) with Crimp Termination

6 positions with earthing / 15 positions with earthing

Socket	Pin	Contact configuration Socket View on the mating side	Description	Part number	Current in A nominal single contact current load	Contact diameter in mm	Termination diameter in mm	Termination cross- section in mm ²	Mating force in N	Demating force in N
			Insulator part A Insulator part B Insulator part C Insulator part D	252.080.001.007.000 252.082.011.107.150 252.081.001.007.000 252.082.012.107.150	18	3.0	3.0	0.5 to 1.5	70 ± 20	60 ± 20
			Insulator part A Insulator part B Insulator part C Insulator part D	252.080.001.016.000 252.082.001.016.000 252.081.001.016.000 252.082.002.016.000	18	2.0	1.5	0.5 to 1.5	90 ± 30	80 ± 25

Crimping tools from [page 73](#).

Operating voltage 6 positions with earthing in metal housing: 250 V / 4 kV / 3

Operating voltage 15 positions with earthing in metal housing: 40 V / 2.5 kV / 3

Dimensions insulator

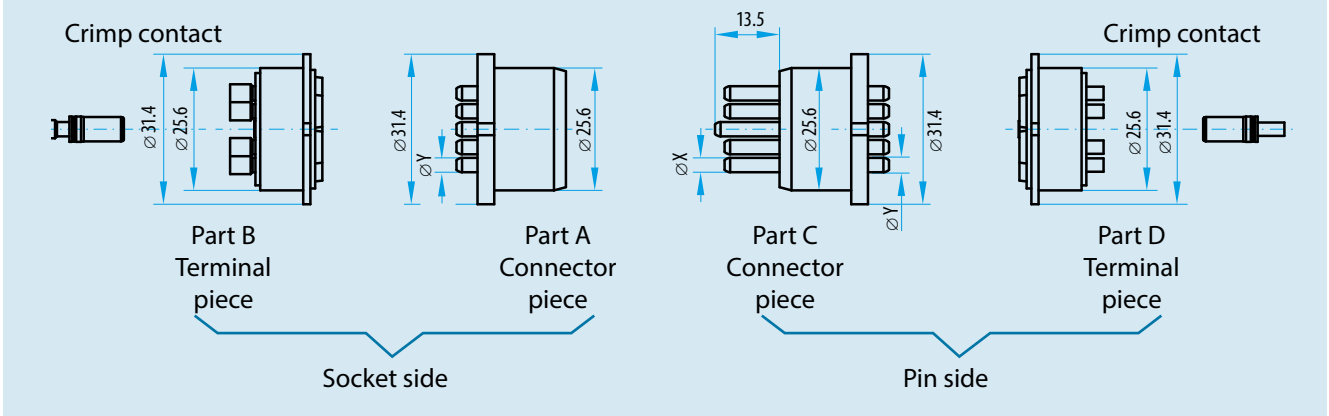

Terminal pieces stay wired.

Connector pieces are exchanged in the Docking System.

Contacts at the Terminal piece B and D are respectively crimp contacts.

Current Carrying Capacity for Fully Equipped Inserts (Excerpt)

Derating curves for crimp inserts

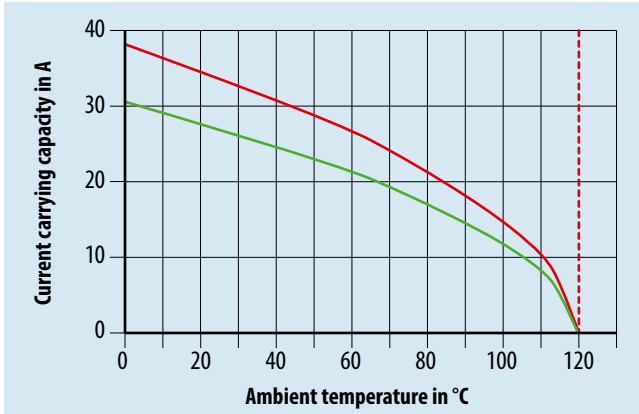

Insert 208.703.004.007.000 with 208.803.004.007.000 equipped with contact diameter 3.0 mm (cable cross-section 2.5 mm²).

For insert 208.803.004.005.000 equipped with contact diameter 3.0 mm (cable cross-section 2.5 mm²) the derating curve from 208.803.004.007.000 can be used.

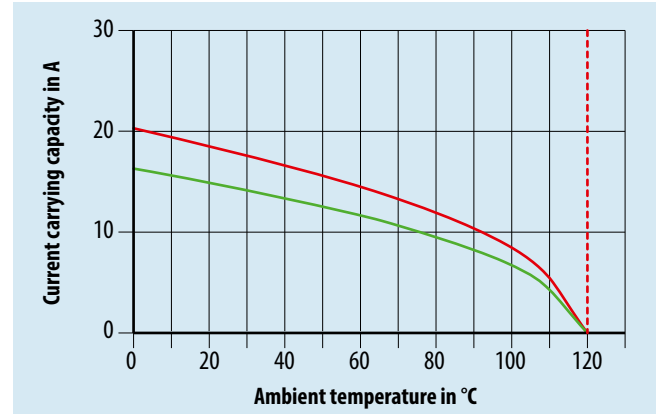

Insert 208.702.004.016.000 with 208.802.004.016.000 equipped with contact diameter 2.0 mm (cable cross-section 1.5 mm²).

ODU DOCK
Size 2

Derating curves for solder inserts

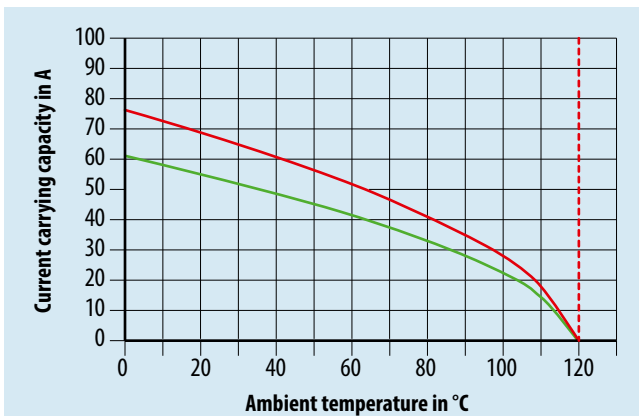

Insert 656.162.704.150.005 with 656.162.804.150.005 equipped with contact diameter 4.0 mm (cable cross-section 6.0 mm²).

Legend of diagrams

- - - Max. temperature of contact material
- Basis curve
- Corrected curve

Further derating curves on request.

ODU DOCK Size 3

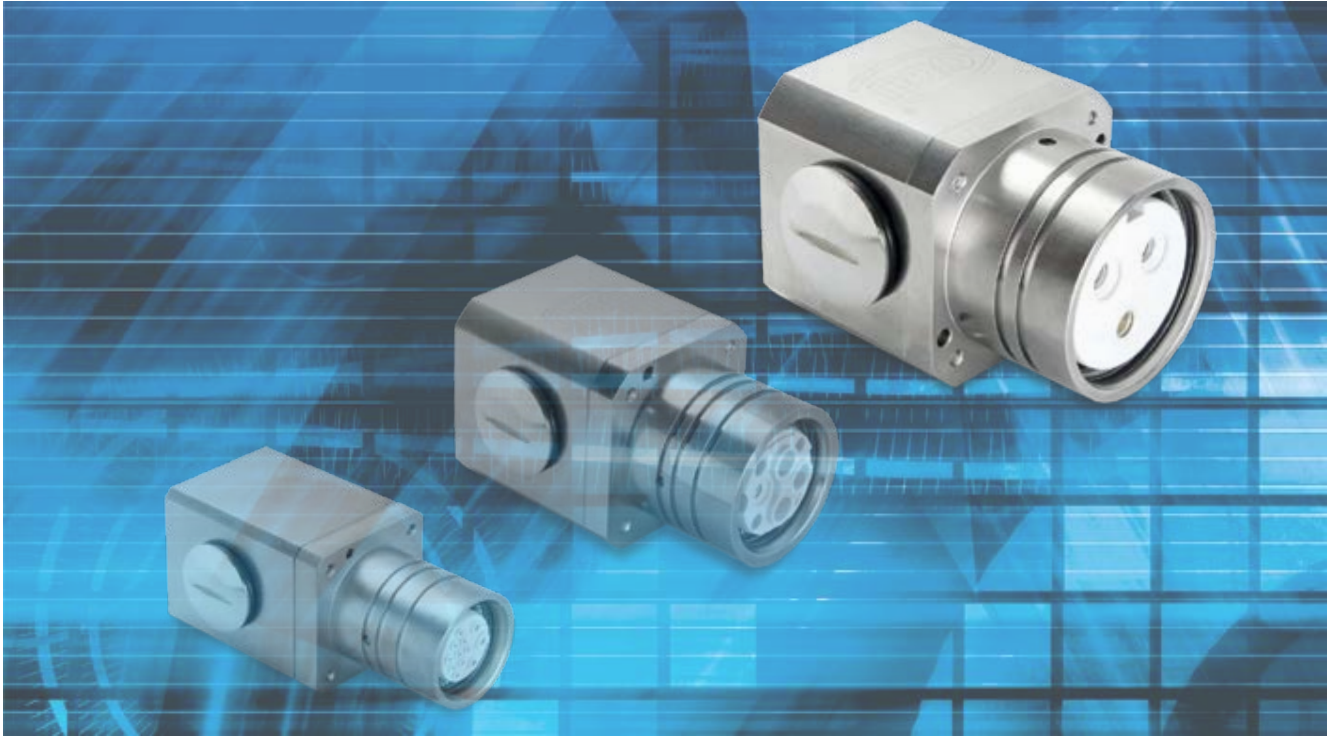

ODU DOCK
Size 3

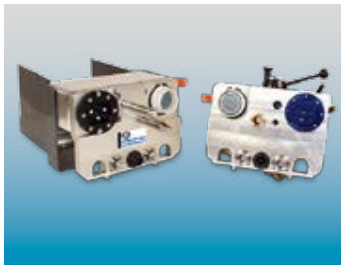

Housing

Plastic



- Material: POM, black
- Protection class: IP 65 in mated condition
- Operating temperature: -40°C up to +100°C
- Easy assembly from rear of panel
- Straight and right-angled cable exit possible, sealing plug for unused cable exit is included in the delivery
- Two-part housing

Description	Part number			
Socket piece	656.163.011.000.000			
Pin piece	656.163.012.000.000			

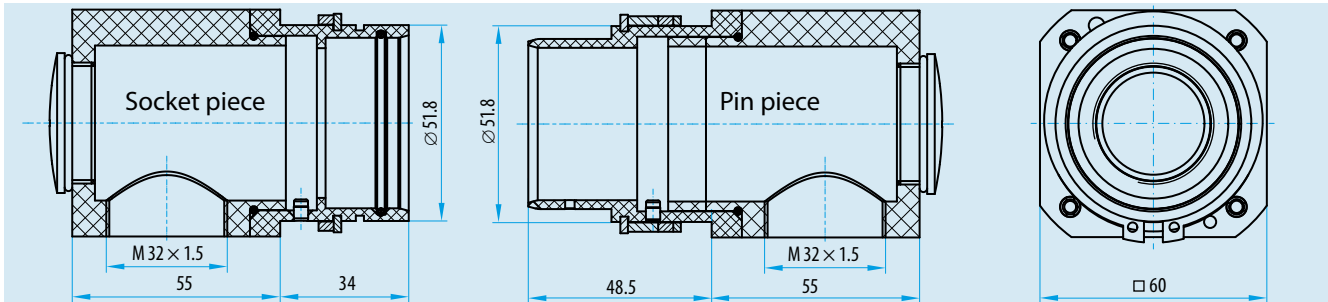

Aluminium, nickel-plated



- Material: aluminium, nickel-plated
- Protection class: IP 65 in mated condition (depends on version)
- Operating temperature: -40°C up to +100°C
- Easy assembly from rear of panel
- Straight and right-angled cable exit possible, sealing plug for unused cable exit is included in the delivery
- Two-part housing
- Available with and without EMC protection

Description	Part number	IP 40	IP 65	EMC protection
Socket piece	656.163.021.000.000		•	•
	656.163.023.000.000	•		
	656.163.024.000.000	•		•
	656.163.025.000.000		•	
Pin piece	656.163.022.000.000	•	•	•

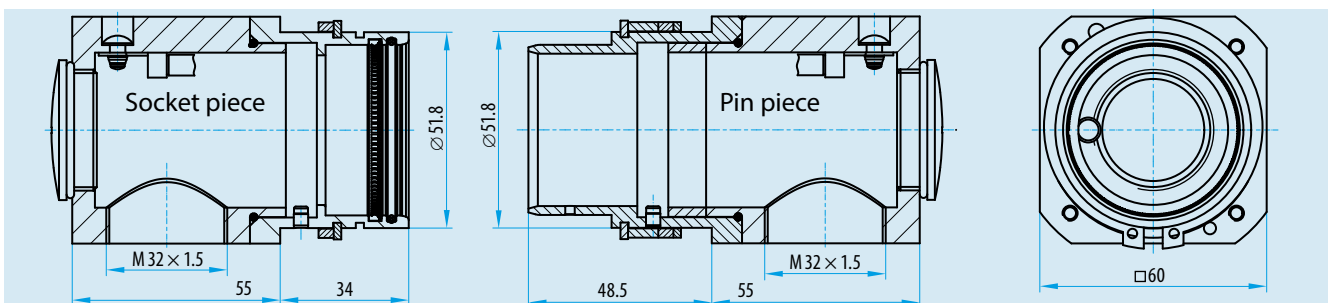

Aluminium, black anodized



- Material: aluminium, black anodized
- Protection class: IP 40
- Operating temperature: -40°C up to +100°C
- Mountable from front of panel
- Straight and right-angled cable exit possible, sealing plug for unused cable exit is included in the delivery
- Two-part housing

Description	Part number	Thread X
Socket piece	656.163.051.000.000	M 32 × 1.5
	656.163.001.000.000	PG 29
Pin piece	656.163.052.000.000	M 32 × 1.5
	656.163.002.000.000	PG 29

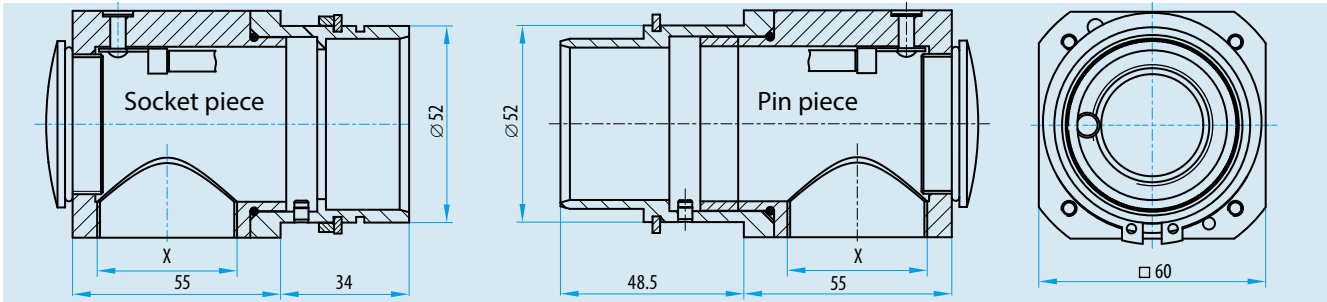

ODU DOCK
Size 3

Assembly drilling for all size 3 versions

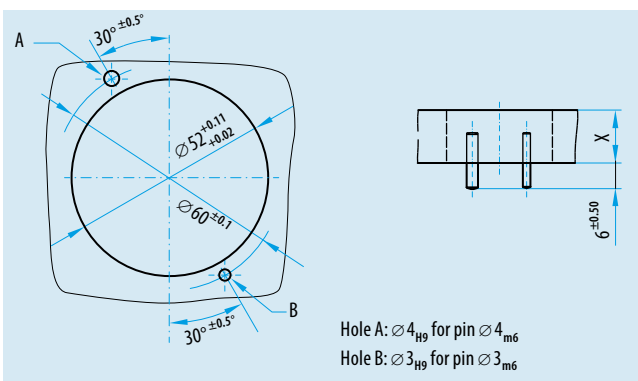



Board spacing
in mated position:
 61 ± 0.5 mm

Board thickness "X"
20 mm: ± 0.1
14 mm: ± 0.1
10 mm: ± 0.1

Pin and Socket Inserts with Crimp Termination

2 positions with earthing

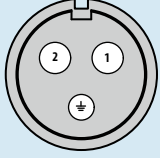
Socket	Pin	Contact configuration Socket View on the mating side	Description	Part number	Current in A nominal single contact current load	Contact diameter in mm	Termination cross- section in mm ²	Mating force in N	Demating force in N
			Insulator socket	209.706.004.003.000					
			Insulator pin	209.806.004.003.000					
			Socket contact	172.929.100.201.000					
			Pin contact	181.146.000.301.000	95	6.0	16.0	60 ± 20	
			Earthing socket	172.930.100.201.000					
			Socket contact	172.927.100.201.000					
			Pin contact	181.144.000.301.000	55	6.0	6.0	60 ± 20	55 ± 20
			Earthing socket	172.928.100.201.000					
			Socket contact	172.925.100.201.000					
			Pin contact	181.142.000.301.000	30	6.0	2.5	60 ± 20	
			Earthing socket	172.926.100.201.000					

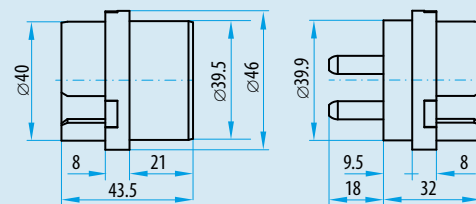

Voltage information acc. DIN EN*)	Metal housing		Plastic housing	
	1,000V	400V	1,600V	800V
Rated voltage				
Rated impulse voltage	5 kV		6 kV	
Pollution degree	2	3	2	3

Dimensions insulator (socket piece/pin piece)



Insulator without holding clip – contacts are inserted from the side.
Crimping tools from page 73.
*DIN EN 60664-1 (VDE 0110-1) : 2008-01

4 positions with earthing

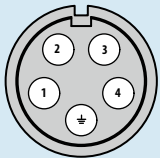
Socket	Pin	Contact configuration Socket View on the mating side	Description	Part number	Current in A nominal single contact current load	Contact diameter in mm	Termination cross- section in mm ²	Mating force in N	Demating force in N
			Insulator socket	209.706.004.005.000					
			Insulator pin	209.806.004.005.000					
			Socket contact	172.650.100.201.000	95	6.0	16	100 ± 35	90 ± 30
			Pin contact	182.504.000.301.000					

Voltage information acc. DIN EN*)	Metal housing		Plastic housing	
	1,000V	400V	1,250V	500V
Rated voltage				
Rated impulse voltage	5 kV		6 kV	
Pollution degree	2	3	2	3

Dimensions insulator (socket piece/pin piece)

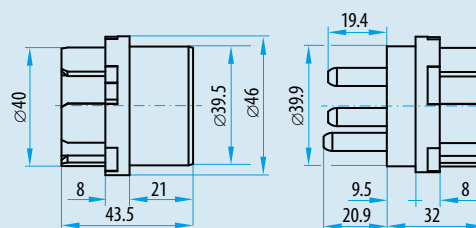

No extra earth contact necessary. Earthing is provided via the insulator geometry.
Insulator without holding clip – contacts are inserted from the side.
Crimping tools from page 73.
*DIN EN 60664-1 (VDE 0110-1) : 2008-01

6 positions with earthing

Socket	Pin	Contact configuration Socket View on the mating side	Description	Part number	Current in A nominal single contact current load	Contact diameter in mm	Termination cross- section in mm ²	Mating force in N	Demating force in N	
			Insulator socket	209.705.004.007.000						
			Insulator pin	209.805.004.007.000						
			Sealing plug socket	021.341.141.924.000						
			Sealing plug pin	021.341.142.924.000						
			Socket contact	170.633.100.201.000						
			Earthing socket contact	170.634.100.201.000	85	5.0	10	130±40	120±40	
			Pin contact	180.633.000.301.000						
			Socket contact	170.452.100.201.000						
			Earthing socket contact	170.453.100.201.000	55	5.0	6			
			Pink contact	180.452.000.301.000						
			Socket contact	172.931.100.201.000						
			Earthing socket contact	172.932.100.201.000	35	5.0	4			
			Pin contact	181.140.000.301.000						
			Socket contact	170.492.100.201.000						
Earthing socket contact	170.493.100.201.000	25	5.0	1.5						
Pin contact	180.492.000.301.000									

Voltage information acc. DIN EN*)	Metal housing		Plastic housing	
	1,600 V	630 V	1,600 V	630 V
Rated voltage	1,600 V	630 V	1,600 V	630 V
Rated impulse voltage	6 kV		6 kV	
Pollution degree	2	3	2	3

Crimping tools from page 73.
*)DIN EN 60664-1 (VDE 0110-1) : 2008-01

Dimensions insulator (socket piece/pin piece)

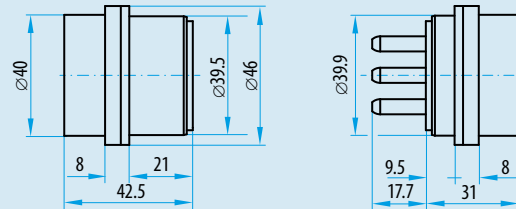

Pin and Socket Inserts with Crimp Termination

13 positions with earthing

Socket	Pin	Contact configuration Socket View on the mating side	Description	Part number	Current in A nominal single contact current load	Contact diameter in mm	Termination cross-section in mm ²	Mating force in N	Demating force in N
			Insulator socket	209.703.004.014.000					
			Insulator pin	209.803.004.014.000					
			Sealing plug socket	021.341.137.300.000					
			Sealing plug pin	021.341.138.300.000					
			Socket contact	172.160.100.201.000					
			Earthing socket contact	172.161.100.201.000	35	3.0	4.0		
			Pin contact	181.160.000.301.000					
			Socket contact	172.918.100.201.000					
			Earthing socket contact	172.919.100.201.000	30	3.0	2.5	130 ± 40	120 ± 40
			Pin contact	181.138.000.301.000					
			Socket contact	172.916.100.201.000					
			Earthing socket contact	172.917.100.201.000	25	3.0	1.5		
			Pin contact	181.136.000.301.000					

Voltage information acc. DIN EN*)	Metal housing		Plastic housing	
	1,600V	630V	1,600V	630V
Rated voltage	1,600V	630V	1,600V	630V
Rated impulse voltage	5 kV		5 kV	
Pollution degree	2	3	2	3

Crimping tools from [page 73](#).
 *)DIN EN 60664-1 (VDE 0110-1) : 2008-01

Dimensions insulator (socket piece/pin piece)

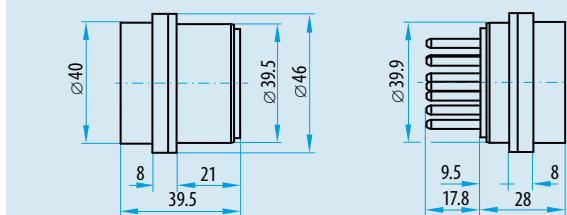

26 positions with earthing

Socket	Pin	Contact configuration Socket View on the mating side	Description	Part number	Current in A nominal single contact current load	Contact diameter in mm	Termination cross-section in mm ²	Mating force in N	Demating force in N
			Insulator socket	209.745.004.027.000	25	1.5	1.5	90 ± 30	80 ± 25
			Insulator pin	209.845.004.027.000					
			Sealing plug socket	021.341.131.923.000					
			Sealing plug pin	021.341.132.923.000					
			Socket contact	170.370.000.201.000					
			Pin contact	181.134.000.301.000					
			Earthing pin contact	181.135.000.301.000					
			Socket contact	172.912.100.201.000					
			Pin contact	181.132.000.301.000					
			Earthing pin contact	181.133.000.301.000					
					12	1.5	0.38 / 0.61		

Voltage information acc. DIN EN*)	Metal housing		Plastic housing	
	800 V	320 V	800 V	320 V
Rated voltage	800 V	320 V	800 V	320 V
Rated impulse voltage	4 kV		4 kV	
Pollution degree	2	3	2	3

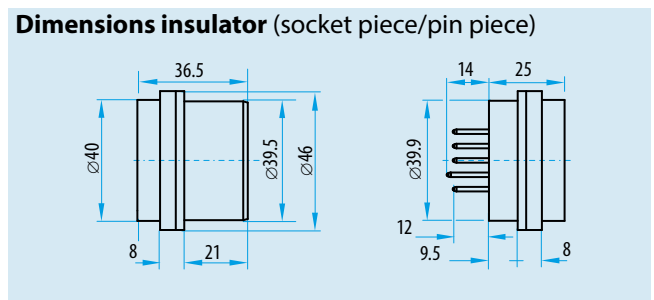

Crimping tools from [page 73](#).
 *DIN EN 60664-1 (VDE 0110-1) : 2008-01

Pin and Socket Inserts with Crimp Termination

36 positions with earthing

Socket	Pin	Contact configuration Socket View on the mating side	Description	Part number	Current in A nominal single contact current load	Contact diameter in mm	Termination cross-section in mm ²	Mating force in N	Demating force in N
			Insulator socket	209.745.004.037.000					
			Insulator pin	209.845.004.037.000					
			Sealing plug socket	021.341.131.923.000					
			Sealing plug pin	021.341.132.923.000					
			Socket contact	170.370.000.201.000					
			Pin contact	181.134.000.301.000	25	1.5	1.5		
			Earthing pin contact	181.135.000.301.000				120 ± 40	110 ± 35
			Socket contact	172.912.100.201.000					
			Pin contact	181.132.000.301.000	12	1.5	0.38 / 0.61		
			Earthing pin contact	181.133.000.301.000					

Voltage information acc. DIN EN*)	Metal housing		Plastic housing	
	800 V	320 V	800 V	320 V
Rated voltage	800 V	320 V	800 V	320 V
Rated impulse voltage	4 kV		4 kV	
Pollution degree	2	3	2	3

Dimensions insulator (socket piece/pin piece)

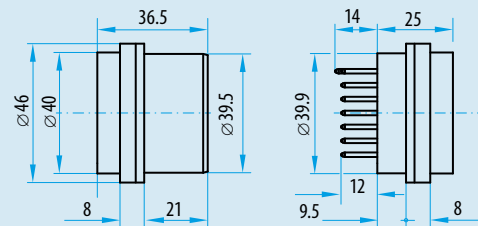

Crimping tools from [page 73](#).
 *DIN EN 60664-1 (VDE 0110-1) : 2008-01

Pin and Socket Inserts with Solder Termination

3 positions with earthing and 2 pilot contacts

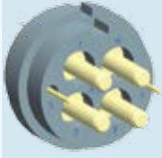
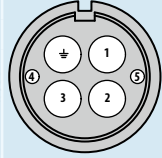
Socket	Pin	Contact configuration Socket View on the mating side	Description	Part number	Current in A nominal single contact current load	Contact diameter in mm	Termination cross-section in mm ²	Mating force in N	Demating force in N
			Socket contact Pin contact	656.163.700.150.006 656.163.800.150.006	95 25	6.0 1.5	4 × 16 2 × 1.5	100 ± 30	90 ± 30

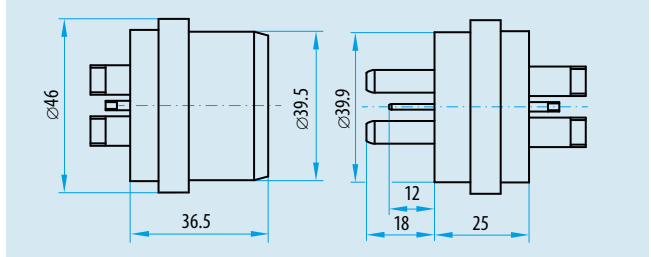

Voltage information acc. DIN EN*)	Metal housing		Plastic housing	
	1,250V	500V	1,250V	500V
for contact diameter 6.0				
Rated voltage	1,250V	500V	1,250V	500V
Rated impulse voltage	5 kV		5 kV	
Pollution degree	2	3	2	3
for contact diameter 1.5				
Rated voltage	630V	250V	1,600V	630V
Rated impulse voltage	4 kV		6 kV	
Pollution degree	2	3	2	3

Dimensions insulator (socket piece/pin piece)



*DIN EN 60664-1 (VDE 0110-1) : 2008-01

3 positions with earthing und 3 pilot contacts

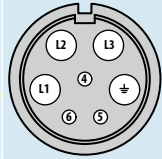
Socket	Pin	Contact configuration Socket View on the mating side	Description	Part number	Current in A nominal single contact current load	Contact diameter in mm	Termination cross-section in mm ²	Mating force in N	Demating force in N
			Socket contact Pin contact	656.163.700.151.007 656.163.800.151.007	85 25	5.0 1.5	4 × 10 3 × 1.5	80 ± 25	70 ± 25

Voltage information acc. DIN EN*)	Metal housing		Plastic housing	
	1,250V	500V	1,600V	630V
for contact diameter 5.0				
Rated voltage	1,250V	500V	1,600V	630V
Rated impulse voltage	5 kV		6 kV	
Pollution degree	2	3	2	3
for contact diameter 1.5				
Rated voltage	1,250V	500V	1,250V	500V
Rated impulse voltage	6 kV		6 kV	
Pollution degree	2	3	2	3

Dimensions insulator (socket piece/pin piece)

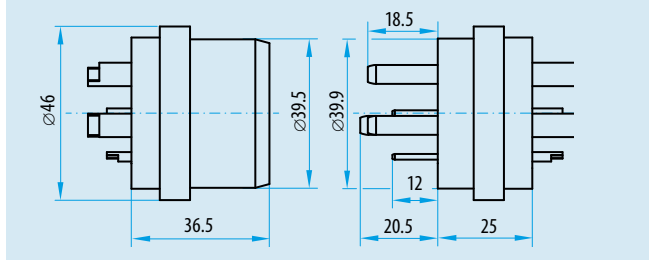

*DIN EN 60664-1 (VDE 0110-1) : 2008-01

Pin and Socket Inserts with Solder Termination

4 positions with earthing

Socket	Pin	Contact configuration Socket View on the mating side	Description	Part number	Current in A nominal single contact current load	Contact diameter in mm	Termination cross-section in mm ²	Mating force in N	Demating force in N
			Socket insert Pin insert	656.163.706.152.005 656.163.806.150.005	95	6.0	16	110 ± 35	100 ± 35

Voltage information acc. DIN EN*)	Metal housing		Plastic housing	
	1,250V	500V	1,250V	500V
Rated voltage	1,250V	500V	1,250V	500V
Rated impulse voltage	5 kV		6 kV	
Pollution degree	2	3	2	3

*DIN EN 60664-1 (VDE 0110-1) : 2008-01

Dimensions insulator (socket piece/pin piece)

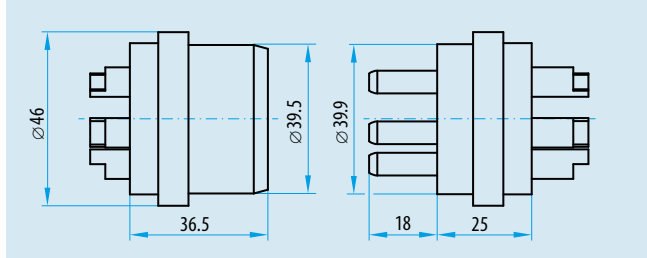

13 positions with earthing

Socket	Pin	Contact configuration Socket View on the mating side	Description	Part number	Current in A nominal single contact current load	Contact diameter in mm	Termination cross-section in mm ²	Mating force in N	Demating force in N
			Socket insert Pin insert	656.163.703.154.014 656.163.803.154.014	35	3.0	4	130 ± 40	120 ± 40

Voltage information acc. DIN EN*)	Metal housing		Plastic housing	
	1,000V	400V	1,250V	500V
Rated voltage	1,000V	400V	1,250V	500V
Rated impulse voltage	4 kV		5 kV	
Pollution degree	2	3	2	3

*DIN EN 60664-1 (VDE 0110-1) : 2008-01

Dimensions insulator (socket piece/pin piece)

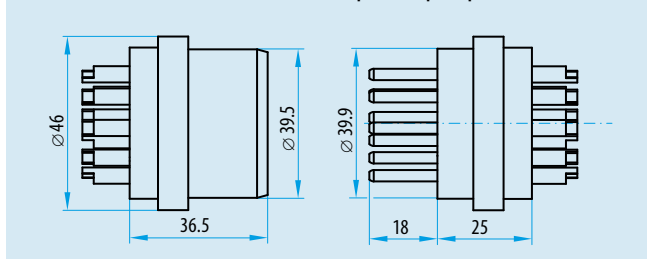

4 positions with earthing / 5 positions with earthing / 6 positions with earthing

Socket	Pin	Contact configuration Socket View on the mating side	Description	Part number	Current in A nominal single contact current load	Contact diameter in mm	Termination cross-section in mm ²	Mating force in N	Demating force in N
			Socket insert Pin insert	656.163.705.150.005 656.163.805.150.005	85	5.0	10	100 ± 35	90 ± 30
			Socket insert Pin insert	656.163.705.150.006 656.163.805.150.006	85	5.0	10	120 ± 40	110 ± 35
			Socket insert Pin insert	656.163.705.150.007 656.163.805.150.007	85	5.0	10	130 ± 40	120 ± 40

Voltage information acc. DIN EN*)	Metal housing		Plastic housing	
	1,000 V	400 V	1,000 V	400 V
Rated voltage	1,000 V	400 V	1,000 V	400 V
Rated impulse voltage	5 kV		5 kV	
Pollution degree	2	3	2	3

*DIN EN 60664-1 (VDE 0110-1) : 2008-01

Dimensions insulator (socket piece/pin piece)

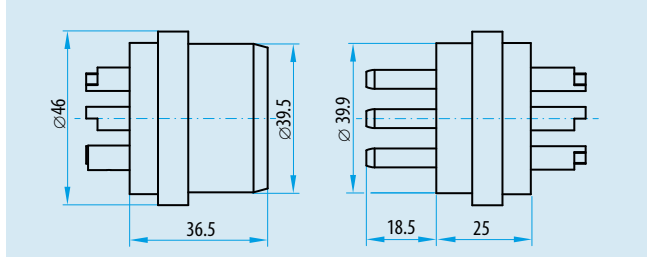

Pin and Socket Inserts with Solder Termination

21 positions with earthing

Socket	Pin	Contact configuration Socket View on the mating side	Description	Part number	Current in A nominal single contact current load	Contact diameter in mm	Termination cross- section in mm ²	Mating force in N	Demating force in N
			Socket insert Pin insert	656.163.746.150.022 656.163.846.150.022	30	2.3	2.5	115 ± 40	105 ± 30

Voltage information acc. DIN EN*)	Metal housing		Plastic housing	
	500 V	200 V	500 V	200 V
Rated voltage	500 V	200 V	500 V	200 V
Rated impulse voltage	3 kV		3 kV	
Pollution degree	2	3	2	3

*DIN EN 60664-1 (VDE 0110-1) : 2008-01

Dimensions insulator (socket piece/pin piece)

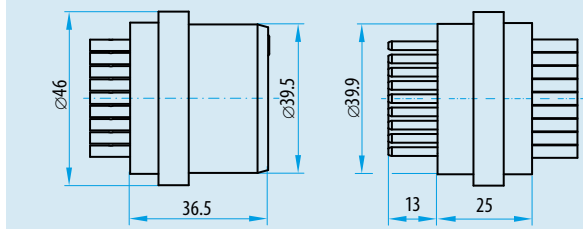

Pin and Socket Inserts with Solder Termination

24 positions with earthing / 26 positions with earthing

Socket	Pin	Contact configuration Socket View on the mating side	Description	Part number	Current in A nominal single contact current load	Contact diameter in mm	Termination cross- section in mm ²	Mating force in N	Demating force in N
			Socket insert Pin insert	656.163.745.150.025 656.163.845.150.025	25	1.5	1.5	85 ± 30	75 ± 25
			Socket insert Pin insert	656.163.745.150.027 656.163.845.150.027	25	1.5	1.5	90 ± 30	80 ± 25

Voltage information acc. DIN EN*)	Metal housing		Plastic housing	
	500V	200V	500V	200V
Rated voltage	500V	200V	500V	200V
Rated impulse voltage	4 kV		4 kV	
Pollution degree	2	3	2	3

*DIN EN 60664-1 (VDE 0110-1) : 2008-01

Dimensions insulator (socket piece/pin piece)

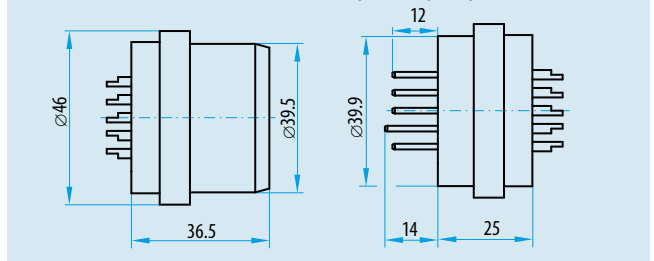

Pin and Socket Inserts with Solder Termination

36 positions with earthing

Socket	Pin	Contact configuration Socket View on the mating side	Description	Part number	Current in A nominal single contact current load	Contact diameter in mm	Termination cross- section in mm ²	Mating force in N	Demating force in N
			Socket insert Pin insert	656.163.745.152.037 656.163.845.152.037	25	1.5	1.5	120 ± 40	110 ± 35

Voltage information acc. DIN EN*)	Metal housing		Plastic housing	
	500 V	200 V	500 V	200 V
Rated voltage	500 V	200 V	500 V	200 V
Rated impulse voltage	3 kV		3 kV	
Pollution degree	2	3	2	3

*DIN EN 60664-1 (VDE 0110-1) : 2008-01

Dimensions insulator (socket piece/pin piece)

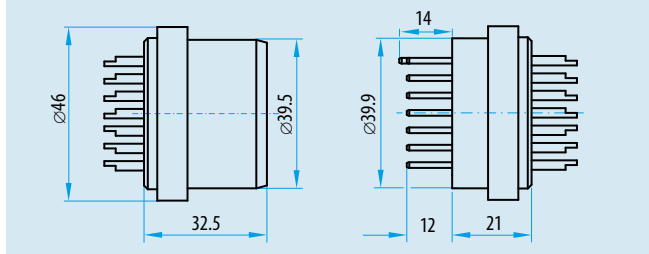

Quick-Change Head System (QCH) with Crimp Termination

26 positions with earthing / 36 positions with earthing

Socket	Pin	Contact configuration Socket View on the mating side	Description	Part number	Current in A		Contact diameter in mm	Termination cross-section in mm ²	Mating force in N	Demating force in N
					nominal single contact current load	Kompletter Einsatz				
			Insulator part A	252.058.002.027.000	16		1.5	0.5 to 1.5	90 ± 30	80 ± 25
			Insulator part B	252.061.002.027.000						
			Insulator part C	252.059.002.027.000						
			Insulator part D	252.061.003.027.000						
			Insulator part A	252.058.001.037.000	16		1.5	0.5 to 1.5	120 ± 40	110 ± 35
			Insulator part B	252.061.001.037.000						
			Insulator part C	252.059.001.037.000						
			Insulator part D	252.061.002.037.000						

Crimping tools from [page 73](#).

Operating voltage 26 positions with earthing in the metal housing: 100V / 2.5 kV / 3

Operating voltage 36 positions with earthing in the metal housing: 63V / 2.5 kV / 3

Dimensions insulator

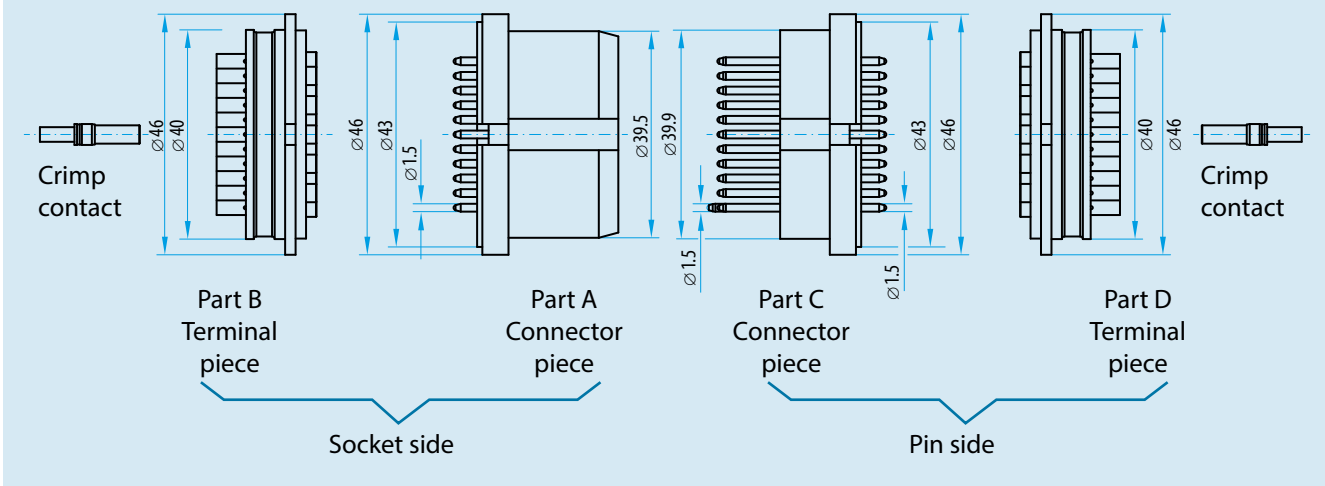

Terminal pieces stay wired.

Connector pieces are exchanged in the Docking System.

Contacts at the Terminal piece B and D are respectively crimp contacts.

ODU DOCK Insert with Modular Construction

The combination of two proven ODU product series allows flexible use of the inserts. You get what you want:

- Combination of ODU DOCK inserts with integrated modules from the ODU-MAC (modular rectangular connector) program
- Room for 8 units (1 unit = 2.54 mm)
- Modules for signals, power, high power, high voltage, fluid, compressed air, fibre-optic and shielded implementation / high-speed-connector can be integrated
- Suitable for housing size 3
- Insulator material: PBT.

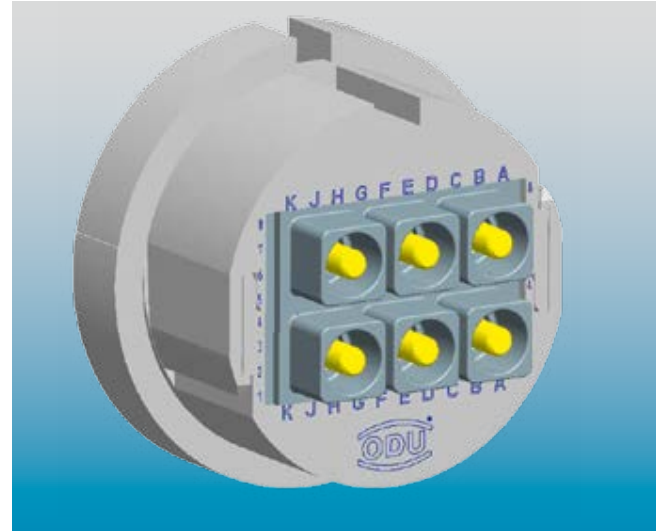



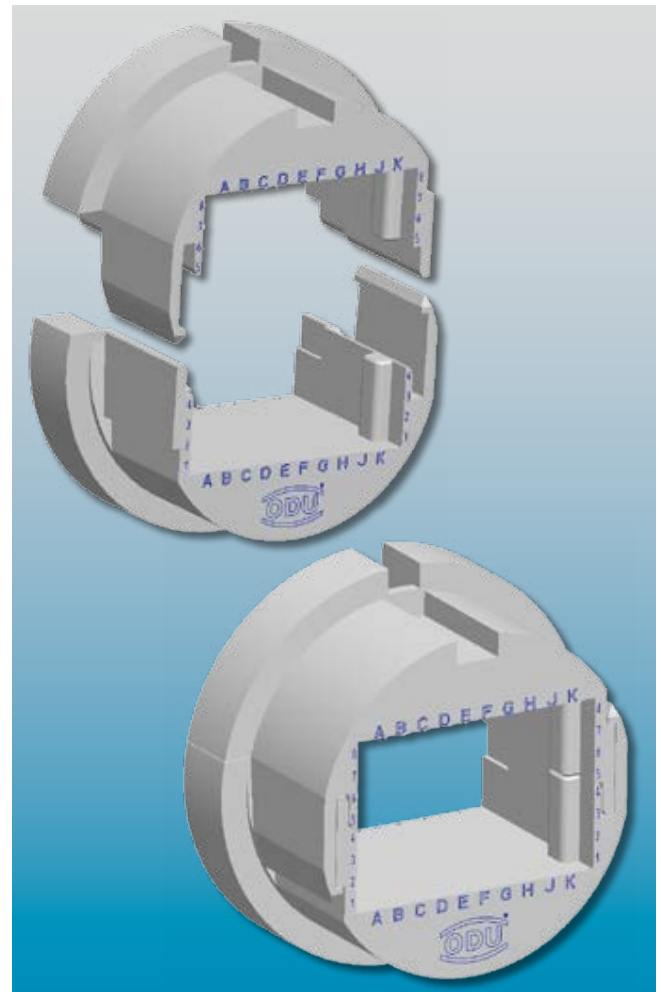

The two-part insulator makes it possible to assemble the ODU-MAC modules without large time expenditures. The modules are simply slide into the insulator and then clipped together after the assembly has been completed.



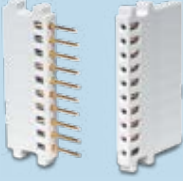

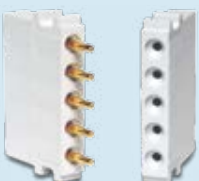



	Part number
Insulator socket	209.610.000.000.000
Insulator pin	209.611.000.000.000

Modules from the ODU-MAC® Program for a Flexible Construction of the ODU DOCK Inserts

Modules	Description	Units/width	Electrical properties
	10 positions for turned contacts contact \varnothing : 0.76 mm	1 unit (2.54 mm)	Operating voltage: ¹⁾ 250V Rated impulse voltage: ¹⁾ 1,500V Continuous current max.: ²⁾ 11 A at 0.38 mm ² Pollution degree: ¹⁾ 2 Mating cycles: min. 100,000
	10 positions for stamped contacts	1 unit (2.54 mm)	Operating voltage: ¹⁾ 32V Rated impulse voltage: ¹⁾ 1,500V Continuous current max.: ²⁾ 6 A at 0.38 mm ² Pollution degree: ¹⁾ 2 Mating cycles: min. 5,000
	6 positions for turned contacts contact \varnothing : 1.02 mm	2 units (5.08 mm)	Operating voltage: ¹⁾ 400V Rated impulse voltage: ¹⁾ 3,000V Continuous current max.: ²⁾ 13.5 A at 0.5 mm ² Pollution degree: ¹⁾ 2 Mating cycles: min. 100,000
	14 positions for turned contacts contact \varnothing : 1.02 mm	3 units (7.62 mm)	Operating voltage: ¹⁾ 320V Rated impulse voltage: ¹⁾ 2,500V Continuous current max.: ²⁾ 13.5 A at 0.5 mm ² Pollution degree: ¹⁾ 2 Mating cycles: min. 100,000
	5 positions for turned contacts contact \varnothing : 1.5 mm	2 units (5.08 mm)	Operating voltage: ¹⁾ 500V Rated impulse voltage: ¹⁾ 2,500V Continuous current max.: ²⁾ 27 A at 1.5 mm ² Pollution degree: ¹⁾ 2 Mating cycles: min. 100,000
	4 positions for turned contacts contact \varnothing : 2.41 mm	3 units (7.62 mm)	Operating voltage: ¹⁾ 500V Rated impulse voltage: ¹⁾ 3,000V Rated current: ²⁾ 28 A at AWG 12 Pollution degree: ¹⁾ 2 Mating cycles: min. 100,000

¹⁾ According to DIN EN 60664.1: 2007 (VDE 0110 part 1).

²⁾ Definition continuous current see [page 92](#).

Modules	Description	Units/width	Electrical properties
	3 positions for turned contacts contact \varnothing : 3.0 mm	3 units (7.62 mm)	Operating voltage: ¹⁾ 500 V Rated impulse voltage: ¹⁾ 3,000 V Continuous current max.: ²⁾ 58 A at 6 mm ² Pollution degree: ¹⁾ 2 Mating cycles: min. 100,000
	2 positions for turned contacts contact \varnothing : 5.0 mm	5 units (12.7 mm)	Operating voltage: ¹⁾ 1,000 V Rated impulse voltage: ¹⁾ 4,000 V Continuous current max.: ²⁾ 119 A at 16 mm ² Pollution degree: ¹⁾ 2 Mating cycles: min. 100,000
	4 positions high voltage module with turned contacts contact \varnothing : 1.5 mm	3 units (7.62 mm)	Operating voltage: ¹⁾ 2,500 V Rated impulse voltage: ¹⁾ 10,000 V Continuous current max.: ²⁾ 27 A at 1.5 mm ² Pollution degree: ¹⁾ 2 Mating cycles: min. 100,000
	3 positions power module with turned contacts contact \varnothing : 3.0 mm	4 units (10.16 mm)	Operating voltage: ¹⁾ 2,500 V Rated impulse voltage: ¹⁾ 10,000 V Continuous current max.: ²⁾ 58 A at 6 mm ² Pollution degree: ¹⁾ 2 Mating cycles: min. 100,000
	2 positions for power contacts ODU LAMTAC® (contacts with lamella technology) with turned contacts contact \varnothing : 8.0 mm	6 units (15.24 mm)	Operating voltage: ¹⁾ 500 V Rated impulse voltage: ¹⁾ 3,000 V Continuous current max.: ²⁾ 154 A at 25 mm ² Pollution degree: ¹⁾ 2 Mating cycles: min. 10,000
	2 positions for power contacts ODU SPRINGTAC® (contacts with springwire technology) with turned contacts contact \varnothing : 8.0 mm	6 units (15.24 mm)	Operating voltage: ¹⁾ 500 V Rated impulse voltage: ¹⁾ 3,000 V Continuous current max.: ²⁾ 142 A at 25 mm ² Pollution degree: ¹⁾ 2 Mating cycles: min. 100,000

¹⁾ According to DIN EN 60664.1: 2007 (VDE 0110 part 1).





²⁾ Definition continuous current see [page 92](#).





Modules	Description	Units/width	Electrical properties																		
	<p>1 position for power contacts ODU LAMTAC® (contacts with lamella technology) contact \varnothing10 mm or contact \varnothing12 mm</p>	<p>7 units (17.78 mm) at both versions</p>	<table border="0"> <tr> <td>Version:</td> <td>10 mm</td> <td>12 mm</td> </tr> <tr> <td>Operating voltage:¹⁾</td> <td>250 V</td> <td>200 V</td> </tr> <tr> <td>Rated impulse voltage:¹⁾</td> <td>4,000 V</td> <td>3,000 V</td> </tr> <tr> <td>Continuous current max.:²⁾</td> <td>179 A at 35 mm²</td> <td>220 A at 50 mm²</td> </tr> <tr> <td>Pollution degree:¹⁾</td> <td>2</td> <td>2</td> </tr> <tr> <td>Mating cycles:</td> <td>min. 10,000</td> <td>min. 10,000</td> </tr> </table>	Version:	10 mm	12 mm	Operating voltage: ¹⁾	250 V	200 V	Rated impulse voltage: ¹⁾	4,000 V	3,000 V	Continuous current max.: ²⁾	179 A at 35 mm ²	220 A at 50 mm ²	Pollution degree: ¹⁾	2	2	Mating cycles:	min. 10,000	min. 10,000
Version:	10 mm	12 mm																			
Operating voltage: ¹⁾	250 V	200 V																			
Rated impulse voltage: ¹⁾	4,000 V	3,000 V																			
Continuous current max.: ²⁾	179 A at 35 mm ²	220 A at 50 mm ²																			
Pollution degree: ¹⁾	2	2																			
Mating cycles:	min. 10,000	min. 10,000																			
	<p>1 position for high voltage contacts</p>	<p>8 units (20.32 mm)</p>	<table border="0"> <tr> <td>Operating voltage:¹⁾</td> <td>6,300 V</td> </tr> <tr> <td>Rated impulse voltage:¹⁾</td> <td>20,000 V</td> </tr> <tr> <td>Pollution degree:¹⁾</td> <td>2</td> </tr> <tr> <td>Mating cycles:</td> <td>min. 10,000</td> </tr> </table>	Operating voltage: ¹⁾	6,300 V	Rated impulse voltage: ¹⁾	20,000 V	Pollution degree: ¹⁾	2	Mating cycles:	min. 10,000										
Operating voltage: ¹⁾	6,300 V																				
Rated impulse voltage: ¹⁾	20,000 V																				
Pollution degree: ¹⁾	2																				
Mating cycles:	min. 10,000																				
	<p>4 positions for 50 Ω coaxial contacts non-magnetic</p>	<p>3 units (7.62 mm)</p>	<table border="0"> <tr> <td>Frequency range:</td> <td>0 to 1.2 GHz</td> </tr> <tr> <td>Mating cycles:</td> <td>min. 60,000</td> </tr> </table>	Frequency range:	0 to 1.2 GHz	Mating cycles:	min. 60,000														
Frequency range:	0 to 1.2 GHz																				
Mating cycles:	min. 60,000																				
	<p>2 positions for 50 Ω coaxial contacts</p>	<p>5 units (12.7 mm)</p>	<table border="0"> <tr> <td>Frequency range:</td> <td>0 to 2.2 GHz</td> </tr> <tr> <td>Mating cycles:</td> <td>min. 100,000</td> </tr> </table>	Frequency range:	0 to 2.2 GHz	Mating cycles:	min. 100,000														
Frequency range:	0 to 2.2 GHz																				
Mating cycles:	min. 100,000																				
	<p>2 positions for 50 Ω coaxial contacts SMA termination</p>	<p>5 units (12.7 mm)</p>	<table border="0"> <tr> <td>Frequency range:</td> <td>0 to 9.0 GHz</td> </tr> <tr> <td>Mating cycles:</td> <td>min. 100,000</td> </tr> </table>	Frequency range:	0 to 9.0 GHz	Mating cycles:	min. 100,000														
Frequency range:	0 to 9.0 GHz																				
Mating cycles:	min. 100,000																				
	<p>2 positions for 50 Ω coaxial contacts high voltage non-magnetic</p>	<p>5 units (12.7 mm)</p>	<table border="0"> <tr> <td>Frequency range:</td> <td>0 to 0.25 GHz</td> </tr> <tr> <td>Mating cycles:</td> <td>min. 100,000</td> </tr> </table>	Frequency range:	0 to 0.25 GHz	Mating cycles:	min. 100,000														
Frequency range:	0 to 0.25 GHz																				
Mating cycles:	min. 100,000																				

ODU DOCK
Size 3

¹ According to DIN EN 60664.1: 2007 (VDE 0110 part 1).

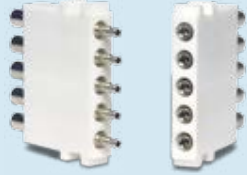
² Definition continuous current see [page 92](#).

Modules	Description	Units/width	Electrical properties
	2 positions for 75 Ω coaxial contacts	5 units (12.7 mm)	Frequency range: 0 to 2 GHz Mating cycles: min. 100,000
	Module 2 positions for compressed air valves	5 units (12.7 mm)	Tube diameter: max. 4 mm Mating cycles: min. 5,000
	Module 1 position for compressed air valve	8 units (20.32 mm)	Tube diameter: max. 6 mm Mating cycles: min. 5,000
	Module 2 positions for compressed air valves	16 units (40.64 mm)	Tube diameter: max. 6 mm Mating cycles: min. 5,000
	Module for fluid coupling plug	5 units (12.7 mm)	Mating cycles: min. 15,000
	2 positions for fibre-optic contacts for plastic fibre	5 units (12.7 mm)	Insertion loss typical: 1.5 dB at 670 nm Mating cycles: min. 100,000

Modules	Description	Units/width	Electrical properties
	5 positions for fibre-optic contacts for plastic fibre POF	2 units (5.08 mm)	Insertion loss typical: 1.5 dB at 670 nm Mating cycles: min. 40,000
	3 positions for fibre-optic contacts for fibre-glass	4 units (10.16 mm)	Insertion loss typical: 1.0 dB at 670 nm Mating cycles: min. 100,000
	2 to 10 positions, shielded implementation / high-speed-connector insert size 0	5 units (12.7 mm)	Mating cycles: min. 5,000 suitable for all common bus systems Ethernet, Firewire®, USB® 3.1 Gen1*
	2 to 14 positions, shielded implementation / high-speed-connector insert size 1	6 units (15.24 mm)	Mating cycles: min. 5,000 With springwire: min. 60,000 suitable for all common bus systems Ethernet*
	4 to 8 positions, shielded implementation / high-speed-connector insert size 2	7 units (17.78 mm)	Mating cycles: min. 5,000 With springwire: min. 60,000 suitable for all common bus systems CAT 6A bis zu 10 Gb/s, Ethernet *
	10 to 30 positions, shielded implementation / high-speed-connector insert size 3	8 units (20.32 mm)	Mating cycles: min. 5,000 suitable for all common bus systems Ethernet*

* For data transmission protocols, please refer to [page 2](#)

Modules	Description	Units/width	Electrical properties	
	Empty modules	1 unit (2.54 mm) 3 units (7.62 mm) 5 units (12.7 mm)		
	Coding modules	1 unit (2.54 mm)		
	Pin protection modules	1 unit (2.54 mm)		

ODU DOCK
Size 3

You can find further information in the catalogue ODU-MAC.

Current Carrying Capacity for Fully Equipped Inserts (Excerpt)

Derating curves for crimp inserts

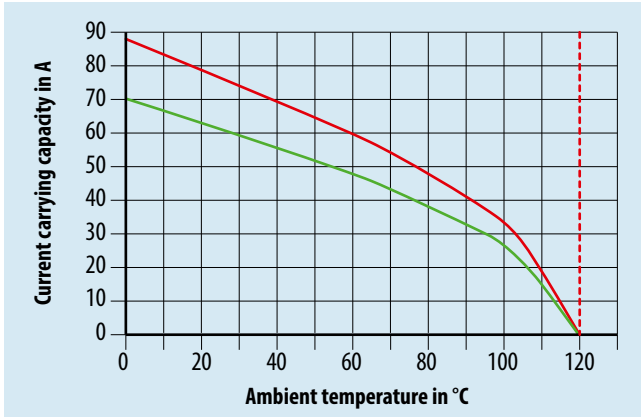

Insert 209.705.004.007.000 with 209.805.004.007.000 equipped with contact diameter 5.0 mm (cable cross-section 10 mm²).

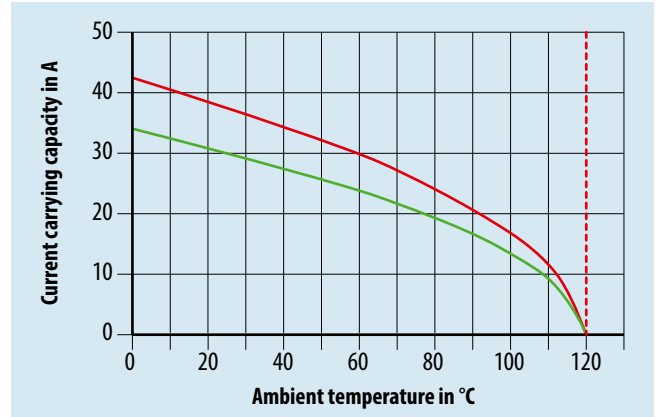

Insert 209.703.004.014.000 with 209.803.004.014.000 equipped with contact diameter 3.0 mm (cable cross-section 4 mm²).

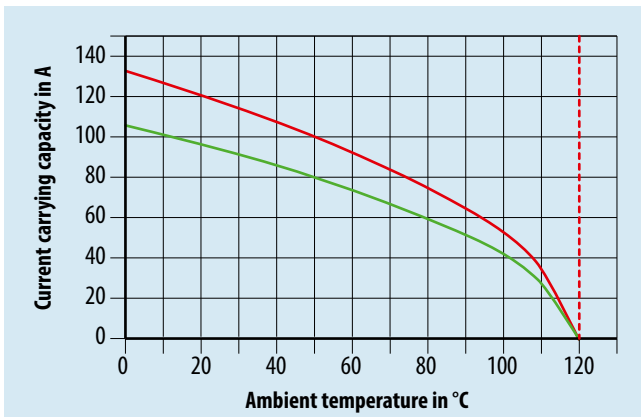

Insert 209.706.004.005.000 with 209.806.004.005.000 equipped with contact diameter 6.0 mm (cable cross-section 16 mm²).

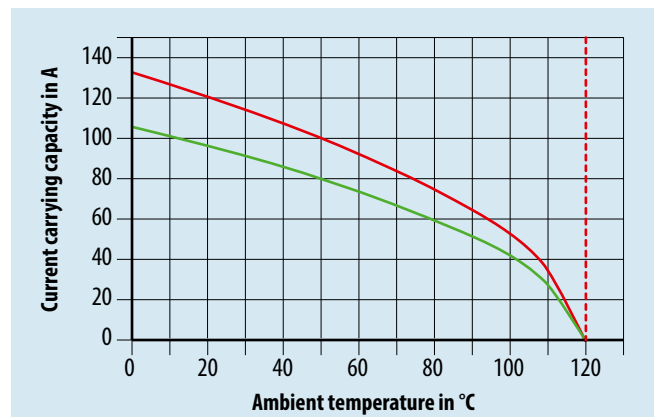

Insert 209.706.004.003.000 with 209.806.004.003.000 equipped with contact diameter 6.0 mm (cable cross-section 16 mm²).

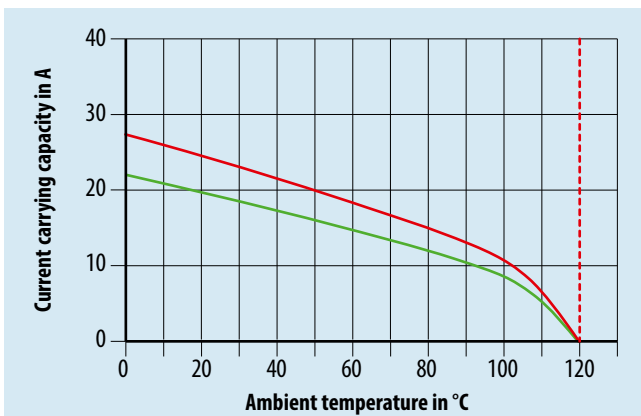

Insert 209.745.004.037.000 with 209.845.004.037.000 equipped with contact diameter 1.5 mm (cable cross-section 1.5 mm²).

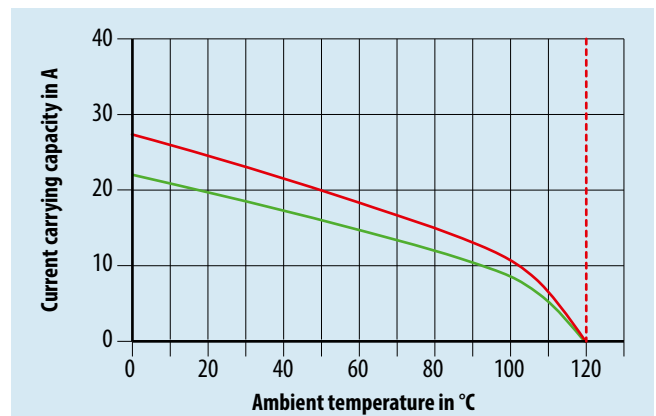

Insert 209.745.004.027.000 with 209.845.004.027.000 equipped with contact diameter 1.5 mm (cable cross-section 1.5 mm²).

Current Carrying Capacity for Fully Equipped Inserts (Excerpt)

Derating curves for solder inserts with mixed inserts

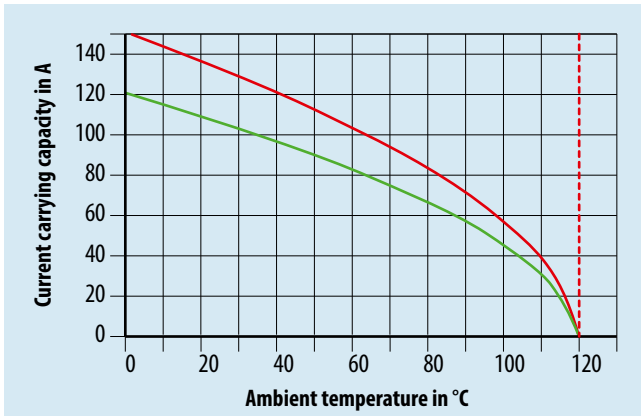

Contact diameter 6.0 mm
Mixed inserts: Insert 656.163.700.150.006 with 656.163.800.150.006 equipped with contact diameter 6.0 mm (cable cross-section $4 \times 16 \text{ mm}^2$) and contact diameter 1.5 mm (cable cross-section $2 \times 1.5 \text{ mm}^2$).

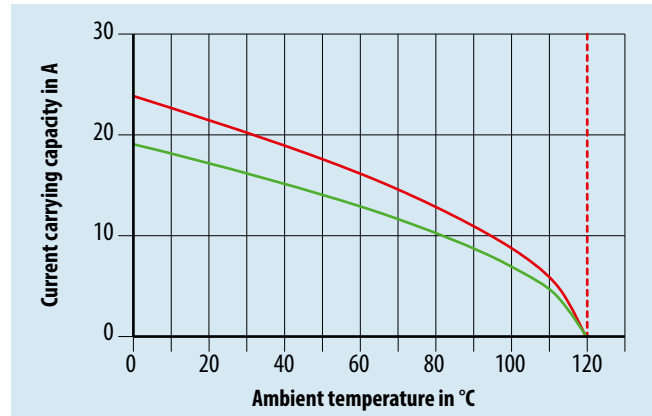

Contact diameter 1.5 mm

ODU DOCK
Size 3

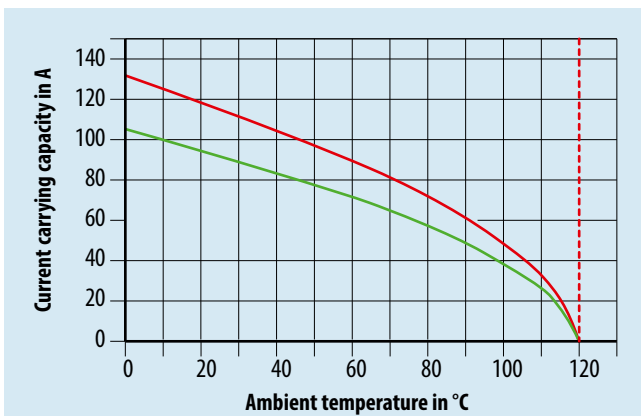

Contact diameter 5.0 mm
Mixed inserts: Insert 656.163.700.151.007 with 656.163.800.151.007 equipped with contact diameter 5.0 mm (cable cross-section $4 \times 10 \text{ mm}^2$) and contact diameter 1.5 mm (cable cross-section $3 \times 1.5 \text{ mm}^2$).

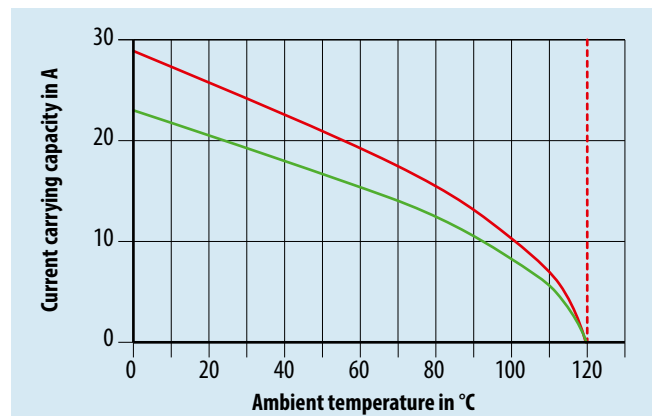

Contact diameter 1.5 mm

Derating curves for solder inserts

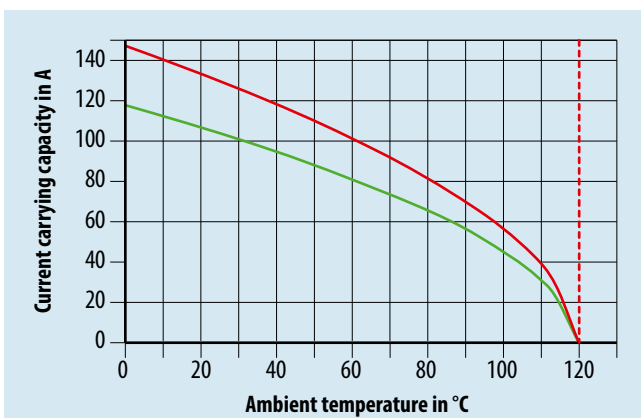

Insert 656.163.706.152.005 with 656.163.806.152.005 equipped with contact diameter 6.0 mm (cable cross-section 16 mm^2).

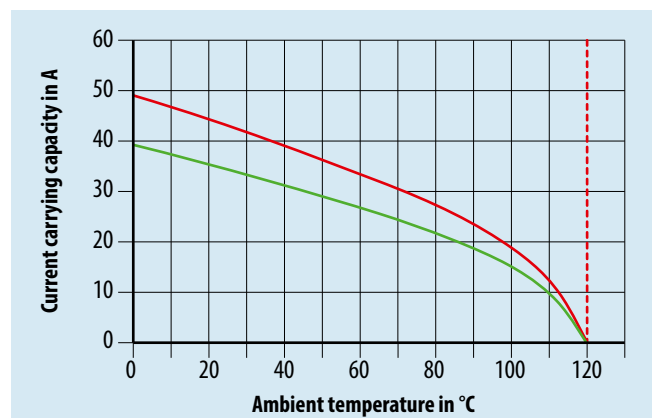

Insert 656.163.703.154.014 with 656.163.803.154.014 equipped with contact diameter 3.0 mm (cable cross-section 4 mm^2).

Current Carrying Capacity for Fully Equipped Inserts (Excerpt)

Derating curves for solder inserts

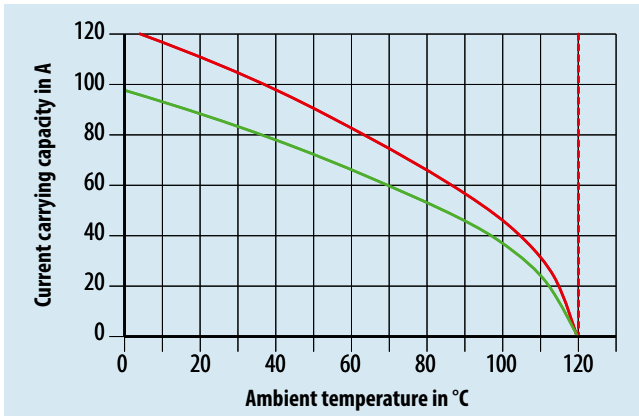

Insert 656.163.705.150.005 with 656.163.805.150.005 equipped with contact diameter 5.0 mm (cable cross-section 10 mm²).

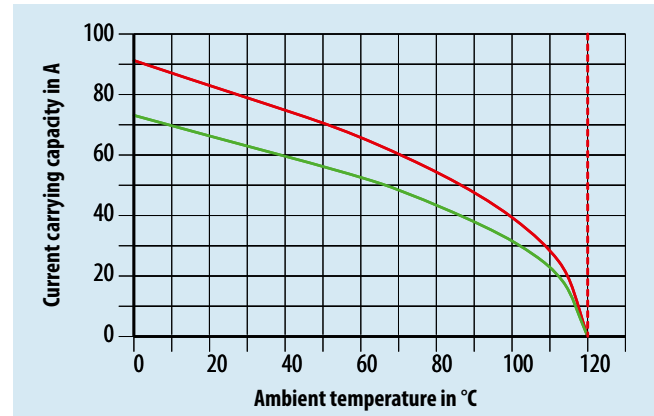

Insert 656.163.705.150.007 with 656.163.805.150.007 equipped with contact diameter 5.0 mm (cable cross-section 10 mm²).

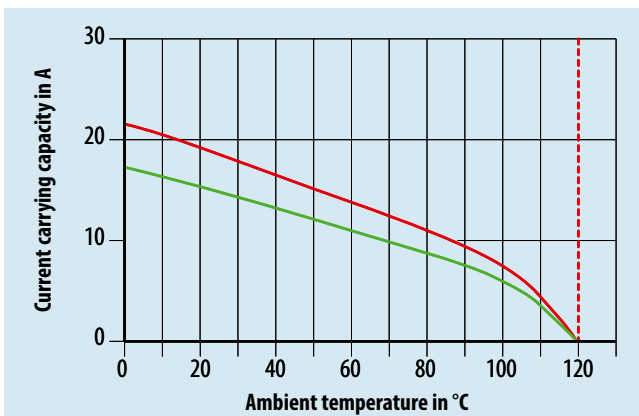

Insert 656.163.746.150.022 with 656.163.846.150.022 equipped with contact diameter 2.3 mm (cable cross-section 2.5 mm²).

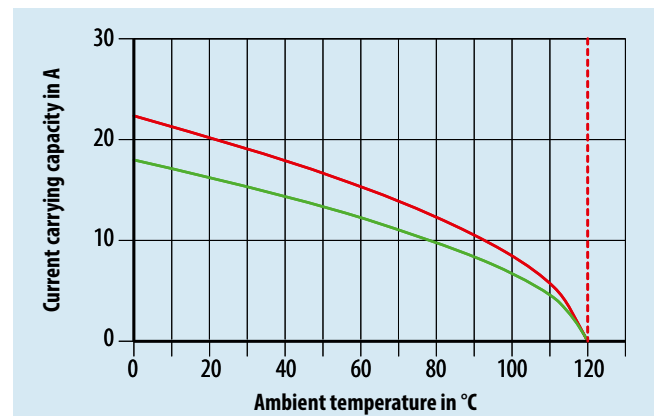

Insert 656.163.745.150.027 with 656.163.845.150.027*^{*)} equipped with contact diameter 1.5 mm (cable cross-section 1.5 mm²).

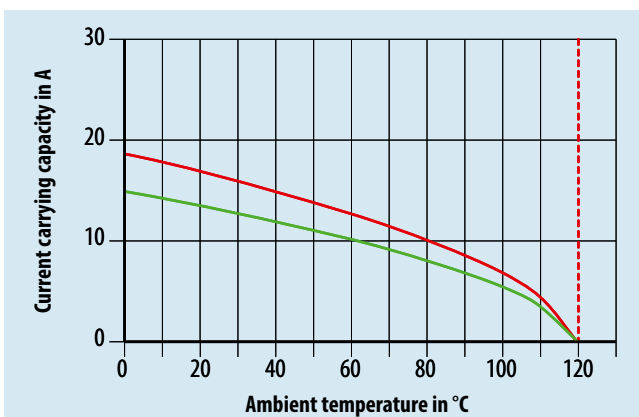

Insert 656.163.745.152.037 with 656.163.845.152.037 equipped with contact diameter 1.5 mm (cable cross-section 1.5 mm²).

* For insert 656.163.745.150.025 with 656.163.845.150.025 equipped with contact diameter 1.5 mm (cable cross-section 1.5 mm²) the derating curve 656.163.745.150.027 with 656.163.845.150.027 can be used.

Legend of diagrams

- Max. temperature of contact material
- Basis curve
- Corrected curve

Further derating curves on request.



ODU DOCK Accessories

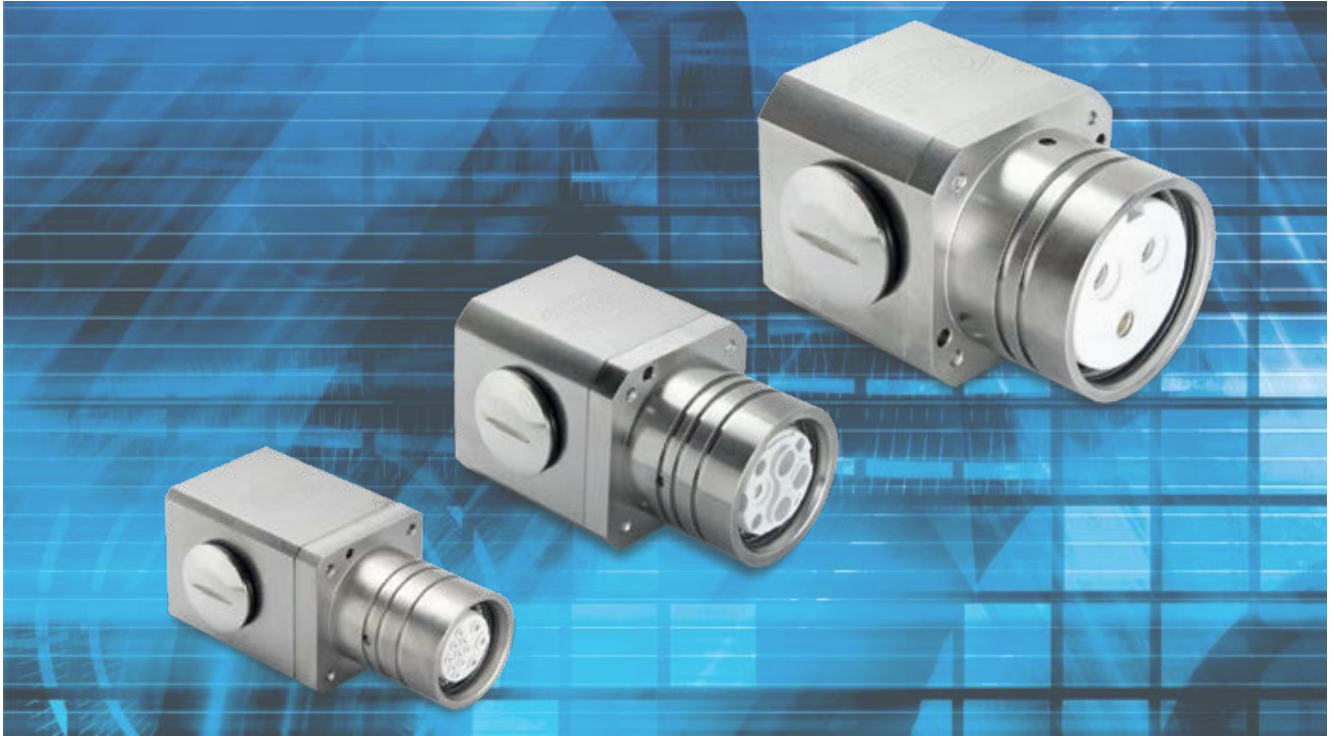

Accessories

Recommended cable clamp

Size	Part number	Cable diameter in mm	Plastic	Metal	For EMC housing	M	PG	Colour
1	026.616.079.169.000	7.9 to 16.9		•			16	brass
	026.616.054.134.000	5.4 to 13.4		•			16	brass
	027.820.070.130.007	7.0 to 13.0	•			20 × 1.5		grey
	028.620.070.125.007	7.0 to 12.5		•	•	20 × 1.5		brass
2	026.621.119.219.000	11.9 to 21.9		•			21	brass
	026.621.054.134.000	5.4 to 13.4		•			21	brass
	027.825.090.170.007	9.0 to 16.5	•			25 × 1.5		grey
	027.825.060.130.007	6.0 to 13.0	•			25 × 1.5		grey
	028.625.090.165.000	9.0 to 16.5		•	•	25 × 1.5		brass
	028.625.070.125.000	7.0 to 12.5		•	•	25 × 1.5		brass
3	026.629.178.298.000	17.8 to 29.8		•			29	brass
	026.629.119.219.000	11.9 to 21.9		•			29	brass
	026.629.070.150.000	7.0 to 15.0		•			29	brass
	027.832.070.150.007	7.0 to 15.0	•			32 × 1.5		grey
	027.832.110.210.007	11.0 to 21.0	•			32 × 1.5		grey
	028.632.110.210.000	11.0 to 21.0		•	•	32 × 1.5		brass
	028.632.090.165.000	9.0 to 16.5		•	•	32 × 1.5		brass

Metric thread cable clamp



PG cable clamp



Material: PA, grey respectively brass, nickel-plated for EMC protection.

Maintenance kit for ODU SPRINGTAC® and ODU LAMTAC® contacts

Contact lubrication improves the mechanical characteristics of contact systems. We recommend that the contact surfaces also be cleaned before being lubricated in order to remove impurities. With proper care, it is possible to minimize significantly the wear caused by frequent matings and reduce the insertion forces. The cleaning and lubrication interval must be adapted individually to the conditions, and these steps should be carried out only with products recommended by the contact manufacturer.

ODU has put together a maintenance kit for this step so that lubrication can be carried out directly at your site. A cleaning brush and a special cleaning towel, together with precise instructions, allow optimal care of the contacts. The maintenance kit can be used for all ODU contacts and connectors as long as no other specifications apply.

Part number: 170.000.000.000.100

The technical characteristics of the maintenance kit are given on our website:
<https://www.odu.de/downloads/>



ODU DOCK Assembly Instruction and Crimp Information

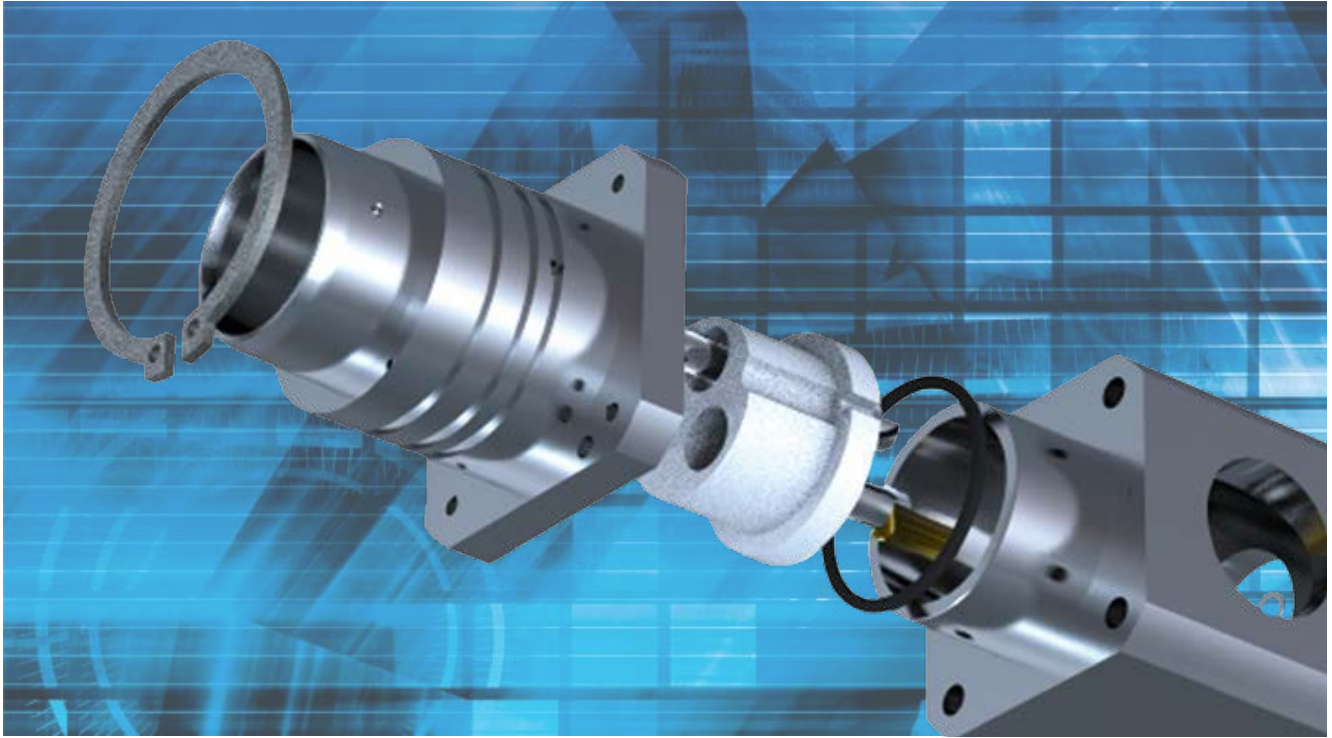

Assembly Instruction

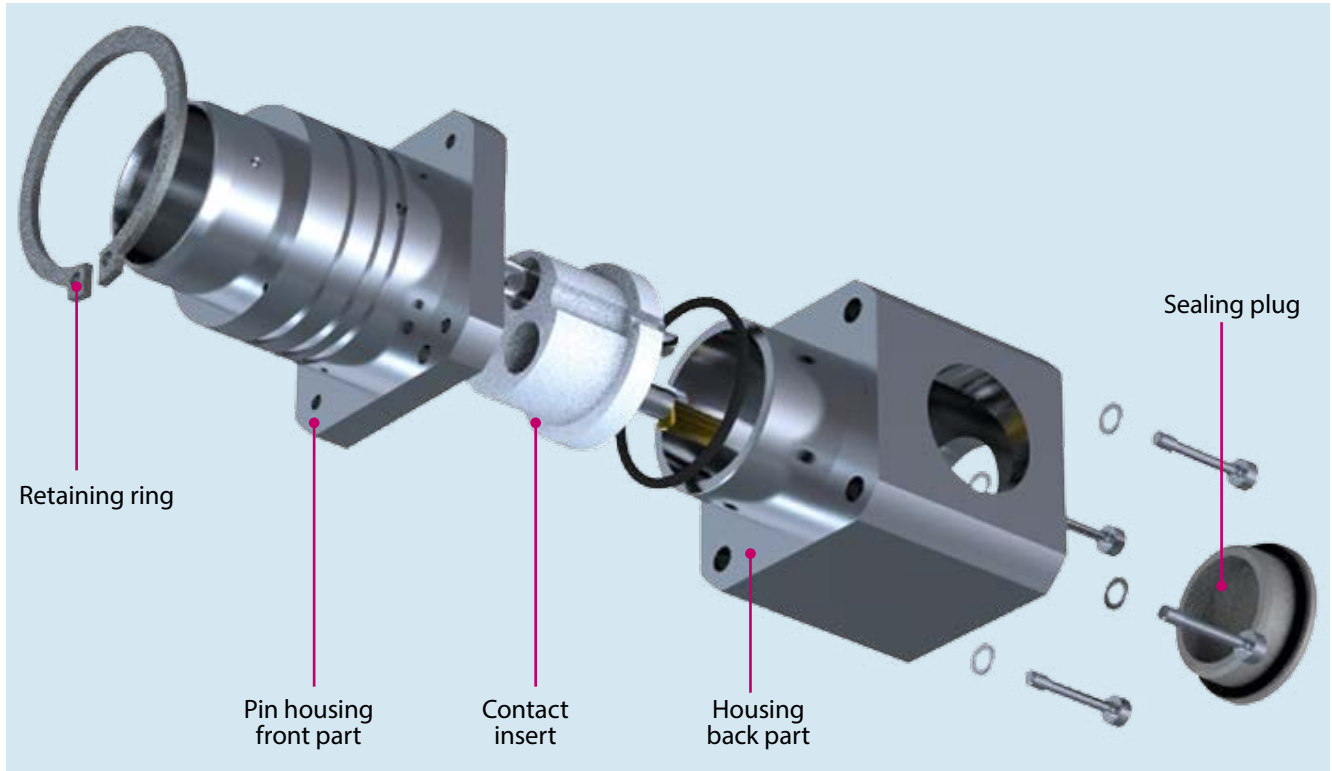

ODU DOCK
Assembly, Crimping

1. Slide the cable clamp and the cables, one after the other, through the back part of the housing.
2. Connect the stripped line to the contacts. If the housing is made of metal, earth the housings earthing wire.
3. Screw the front and back parts of the housing together and tighten the cable clamp.
4. Slide the complete housing into the docking plate and fix in place with retaining ring.

Tightening torque:

Size I und II = 0.8 N
Size III = 2 N

Crimping Tools and Contact Preparation

Contact processing for the production of connecting cables via crimping creates a secure, durable and corrosion-free contact. It requires little skill and can be performed by non-experts.

The cold pressing operation compresses the conductor and contact material, creating a gas-tight connection between contact and conductor. A stiffening of the conductor at the connection, as it is possible with soldering, cannot occur.

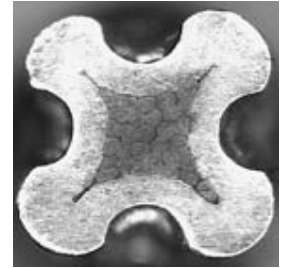
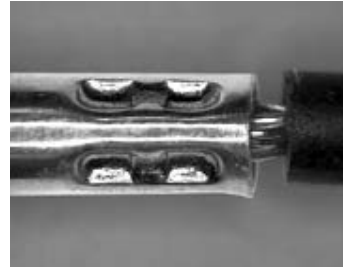

8-point crimping tool

For cross-sections from 0.08 to 2.5 mm² (AWG 28 to AWG 12)*. The crimping tool has an internal ratchet which opens only after the crimp process has been completed. With user-friendly digital display. Part number: 080.000.051.000.000



8-point crimping tool

For cross-sections from 0.38 to 2.5 mm² (AWG 22 to AWG 12)*. The crimping tool has an internal ratchet which opens only after the crimp process has been completed. Part number: 080.000.038.000.000

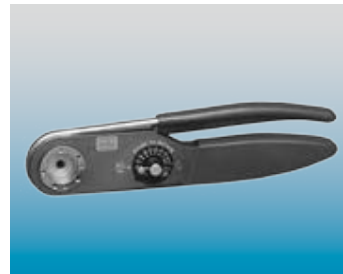

Hexagonal crimping tool

For cross-sections of 1.5 mm², 2.5 mm², 4.0 mm² and 6.0 mm². The crimping tool has an internal ratchet which opens only after the crimp process has been completed. Part number: 080.000.062.000.000

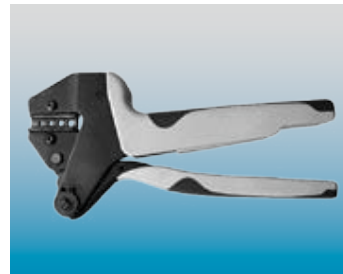

Hydraulic crimping tool

For cross-sections of 16 mm² und 16 mm²*. The crimping tool has an internal ratchet which opens only after the crimp process has been completed. With safety valve for automatic release when correct pressure is reached. Part number: 080.000.026.000.000

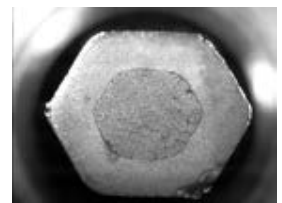

Microsection hexagonal crimping

*Table of adjustment and positioner see next page.

Crimp information size 1

Termination cross-section		Contact diameter	Stripping length	8-point crimping tool 080.000.051.000.000	Hexagonal crimping tool 080.000.062.000.000
mm ²	AWG	mm		Setting ∅ "Y" positioner 080.000.051.103.000	Profile no. Check gauge "X"
0.08/0.25	24/28	0.76	4.5	0.67 Pos. position 1	
0.38	22	0.76	4.5	0.67 Pos. position 1	
0.38/0.50	20/22	1.02	5	0.92 Pos. position 2	
		2	6	0.92 Pos. position 4	
1.0		1.02	5	1.12 Pos. position 2	
		2	7	1.12 Pos. position 4	
1.5	16/15/14*	1.5	5	1.42 Pos. position 3	
		2	7	1.42 Pos. position 4	
		3	8	1.42 Pos. position 5	
2.5	14/13/10*	3	9	1.62 Pos. position 5	2 2.8±0.05

* Use only according to conductor design specifications!

Crimp information quick-change head

Termination cross-section		Contact diameter	Stripping length	8-point crimping tool 080.000.051.000.000	8-point crimping tool 080.000.038.000.000
mm ²	AWG	termination area mm		Setting ∅ "Y" positioner 080.000.051.103.000	Position-no. contact holder
0.5 to 1.0	18 to 20	0.9	4+0.5	1.12 Pos. position 4	
0.5	20	1.5	6+0.5	1.07 Pos. position 4	
0.75				1.12 Pos. position 4	
1	18			1.12 Pos. position 4	
1.5	14			1.42 Pos. position 4	
0.5	20	3	4+0.5		4
0.75					5
1	18				
1.5	14				6

Crimp information size 2

Termination cross-section		Contact diameter mm	Stripping length mm	8-point crimping tool 080.000.051.000.000	Hexagonal crimping tool 080.000.062.000.000
mm ²	AWG			Setting Ø "Y" positioner 080.000.051.103.000	Profile no. Check gauge "X"
1.0		2	7	1.12 Pos. position 4	
1.5		1.5 socket	5	1.42 Pos. position 3	
		1.5 pin	8	1.42 Pos. position 6	
		2	7	1.42 Pos. position 4	
		3	8	1.42 Pos. position 5	
2.5		3	9	1.62 Pos. position 5	2 2.8±0.05
4.0		3	9		3 3.5±0.05

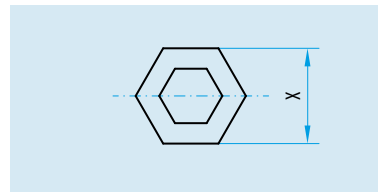

Check gauge (contact)
for hexagonal crimping tools

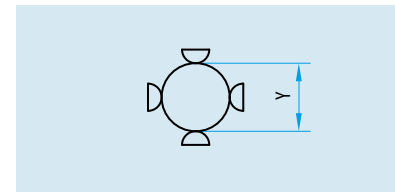

Adjustment dimension (tool)
for 8-point crimping tools

Crimp information size 3

Termination cross-section		Contact diameter	Stripping length	8-point crimping tool *	8-point crimping tool	Hexagonal crimping tool	Hexagonal crimping tool
mm ²	AWG	mm	mm	080.000.014.000.000 Setting ∅ "Y" positioner	080.000.051.000.000 Setting ∅ "Y" positioner 080.000.051.104.000 Positioning setting (socket/PE socket/pin)	080.000.062.000.000 Profile no. Check gauge "X"	080.000.026.000.000 Check gauge "X" crimping jaws
0.08 to 0.25	28/24	1.5	8	0.65 < Y < 0.70 021.345.197.300.000	0.67 (1 / .. / 2)		
0.38 to 0.61		1.5	8	0.90 < Y < 0.95 021.345.197.300.000 021.345.202.300.000 **	0.92 (1 / .. / 2) (6 / .. / 7) **		
1.5	16/15/14*	1.5	8	1.40 < Y < 1.45 021.345.197.300.000	1.42 (1 / .. / 2)		
		3		1.40 < Y < 1.45 021.345.197.300.000	1.42 (3 / 8 / 5)		
		5	10			1 2.15 ± 0.05	
2.5	14/13/12*	3	9		1.62 (3 / 8 / 5)	2 2.8 ± 0.05	
		6	10				
4		3	10			3 3.5 ± 0.05	
		5					
6		5	10			3 3.5 ± 0.05	
		6				4 4.2 ± 0.05	
10		5	11				080.000.026.110.000
16		6	13				6.5 ± 0.05 080.000.026.116.000
		11					

* Use only according to conductor design specifications!

** Longitudinally watertight

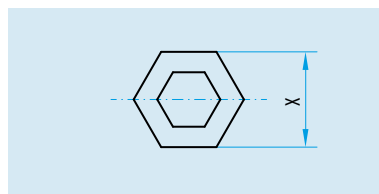

Check gauge (contact) for hexagonal crimping tools

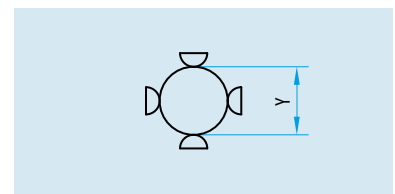

Adjustment dimension (tool) for 8-point crimping tools

Removal Tools for Crimp Contacts

Removal of the already assembled contact (including cable)

Contact diameter mm	Straight model	Right-angle model	Half-shells
0.76	-----	087.170.361.000.000	
1.02	-----	087.170.362.000.000	
1.5	087.170.138.000.000	087.170.363.000.000	
2.0	-----	087.170.364.000.000	
3.0	087.170.136.000.000	087.170.366.000.000	
5.0	-----	-----	087.170.391.000.000



Straight model



Right-angle model

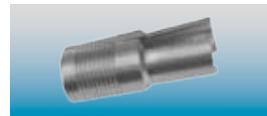

Half-shells

Removal of the contact that has not yet been assembled

Contact diameter mm	Straight model		
0.76			
1.02			
1.5	087.611.001.001.000		
3.0			

Without cable – may have to be cut.



Tool for crimp contacts in the quick-change head version

Contact diameter mm	Insertion tool	Removal tool
1.5 und 2.0	085.170.323.000.000	087.170.323.000.000
3.0	085.178.069.000.000	087.178.057.000.000

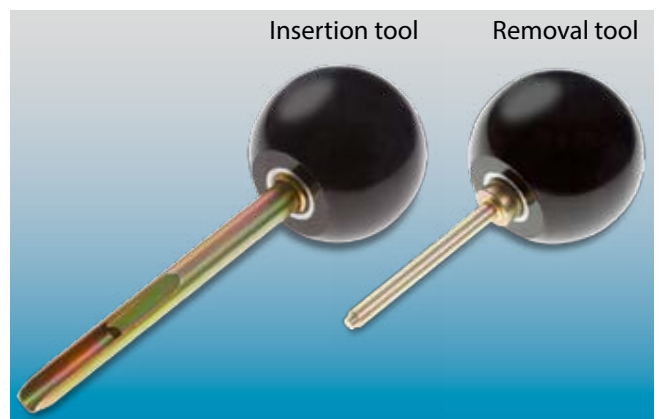

Application Specific Connectors for Docking and Robot Systems

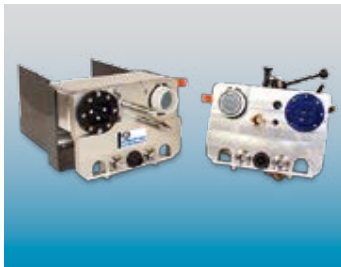
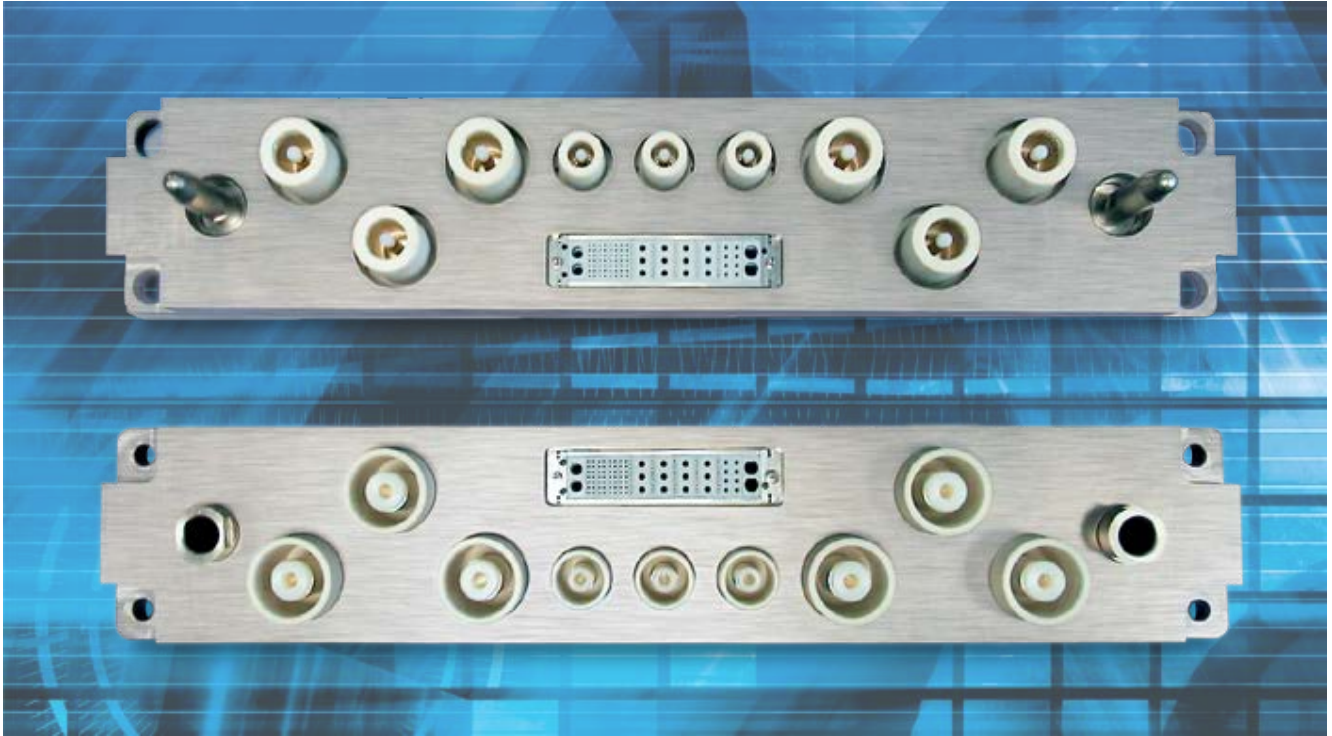

Additional Docking Connectors

Modular rectangular connector

The frames can be given a floating mounting and consequently automatically docked. There are versions with axial play of ± 0.4 mm and radial play of ± 1.2 mm.

Modules are available for signals, power, high frequency, fibre-optic, pneumatic, media and shielded implementations / high-speed-connectors.



Small docking connectors

Docking connectors from the ODU MINI-SNAP series L Push-Pull product program can have an outer diameter from 9.5 to 24 mm. The pin and groove coding makes incorrect mating almost impossible.

Suitable for creating a docking connection between two devices (such as at a charging station) 2 to 40 positions. Versions with IP 50 and IP 68 sealing of the end device are available.



Application Specific Docking Systems



Application specific docking unit for AC/DC converter. Interface to the inverter.

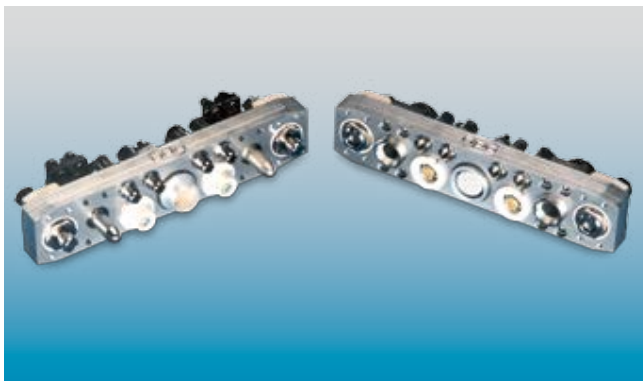

Application specific docking unit for electric cars.



Application specific docking unit for electric cars.

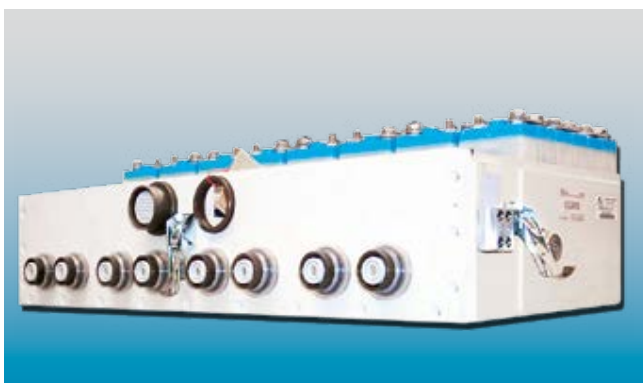

Application specific docking units for the Transrapid in Shanghai.

Docking plate in magnetic resonance imaging (contacting of the gradient coil) with 6 contact pins, diameter 22 mm.



Technical Information



International Protection (IP) Classes in Accordance with DIN EN 60 529 (or IEC 529 /VDE 0470 T1, respectively)

Code letters (International Protection)		First code number (Protection against solid foreign bodies)		Second code number (Protection against water)		
IP		6		5		
Code number	Extent of protection		Code number	Extent of protection		
0	No protection		No protection against contact, no protection against solid foreign bodies	0	No protection against water	No protection against water
1	Protection against large foreign bodies		Protection against large-surface contact with the back of the hand, protection against foreign bodies $\varnothing \geq 50$ mm	1	Protection against dripping water	Protection against vertically falling water drops
2	Protection against medium-sized foreign bodies		Protection against contact with the fingers, protection against foreign bodies. $\varnothing \geq 12$ mm	2	Protection against dripping water when tilted	Protection against falling water drops when tilted (any angle up to 15° from the vertical)
3	Protection against small foreign bodies		Protection against contact with tools, wires, or the like with $\varnothing \geq 2.5$ mm, protection against foreign bodies $\varnothing \geq 2.5$ mm	3	Protected against spraying water	Protection against water spraying at any angle up to 60° from the vertical
4	Protection against granular foreign bodies		The same as 3, except $\varnothing \geq 1$ mm	4	Protection against splashing water	Protection against splashing water from all directions
5	Protection against dust deposits		Protection against contact, protection against harmful dust deposit in the interior	5	Protection against water jet	Protection against water jet (nozzle) from any angle
6	Protection against dust ingress		Protection against foreign bodies $\varnothing \geq 1$ mm, protection against dust ingress	6	Protection against powerful water jet	Protection against powerful water jet from any angle
				7	Protection against immersion	Protection against water ingress during temporary immersion
				8	Protection against continuous immersion	Protection against pressurized water during continuous immersion
				9	Protection against high pressure	Protection against water from high-pressure/ steam jet cleaners.

Explanations and Information in Compliance with VDE

Standards applied

DIN EN 60664-1 (VDE 0110 – part 1) and
DIN EN 61984 (VDE 0627)
(Original DIN EN 60664-1:2007 and DIN EN 61984:2009
remain authoritative for all technical information given).

General information

A connector cannot be chosen by taking into consideration only functionality, number of contacts and current or voltage characteristics. The consideration of the place where it will be used and the installation conditions that prevail there are essential. Depending on the installation conditions and local conditions, the connector can be used in different voltage and current ranges, according to the standardization.

All voltage information listed in this catalog refers to use of insulators in ODU MAC massive frame for DIN housings or ODU MAC aluminium frames.

The most important influencing quantities and the electrical characteristics tuned to them are explained in more detail in the following. If you have further questions, we would be happy to provide support.

The following texts and tables are excerpts from the specified standards. The originals, DIN EN 60664-1 from Nov. 2003 and DIN EN 61984 from Sep. 2002, remain authoritative for all technical information given.

Overvoltage category

Using the overvoltage category, the necessary rated impulse voltage is defined according to table F.1 and the nominal voltage used. The particular overvoltage category for the device, depending on the installation location, is selected according to the criteria listed below.

– Overvoltage category I

Devices for connection to electric circuits in which measures have been taken to limit transient overvoltages to a suitable low level.

For example: Connectors for the power supply of computer hardware that is permanently connected to a power pack with electronic overvoltage limiting.

– Overvoltage category II

Devices that consume energy and that are supplied from the fixed wiring system.

For example: Household appliances, portable tools and similar devices.

– Overvoltage category III

(= standard, if no special overvoltage category is given).

Devices in fixed wiring systems and for those cases in which particular demands are placed on the reliability and availability of the devices.

For example: Switches in fixed wiring systems and devices for industrial use with permanent connection to the fixed wiring system.

– Overvoltage category IV

Devices for use at the wiring system connecting point.
For example: Electric meters and primary overvoltage protective devices

DIN EN 60664-1: Table F.1 – Rated impulse voltage for devices that are fed directly from the low-voltage system.

Nominal voltage of the electric power supply system according to IEC 60038		Voltage line to neutral, derived from nominal voltages a.c. or d.c. up to and including	Rated impulse voltage			
Three-phase-system	Single-phase-system		Overvoltage category			
V	V	V	I	II	III	IV
			V	V	V	V
		50	330	500	800	1500
		100	500	800	1,500	2,500
	120 to 240	160	800	1500	2,500	4,000
230/400 277/480		300	1,500	2,500	4,000	5,000
400/692		600	2,500	4,000	6,000	8,000
1,000		1,000	4,000	6,000	8,000	12,000

Pollution degree

Combined with moisture, any pollution that may arise can influence the insulating property on the surface of the connector. For defining the different rated values, a pollution degree must be selected for the device, according to the criteria listed below. For a connector with a degree of protection of at least IP 54 (to IEC 60529), the insulating parts inside the encapsulation may be measured for a lower pollution degree according to the standard. This also applies to inserted connectors where the encapsulation is ensured by the connector housing and that are detached only for testing and maintenance purposes.

– Pollution degree 1

There is either no pollution or only dry, non-conductive pollution; the pollution has no influence.
For example: Measuring instruments and hardware in computer systems.

– Pollution degree 2

Only non-conductive pollution occurs. Transient conductivity caused by dewfall must be expected occasionally, however.
For example: Devices in laboratories and in living areas and sales and other commercial areas.

– Pollution degree 3

(= standard, if no special pollution degree is given).
Conductive pollution occurs or dry, non-conductive pollution that becomes conductive because of dewfall must be expected.
For example: Devices in industrial, commercial and agricultural operations, unheated storage areas and workshops.

– Pollution degree 4

Continuous conductivity occurs, caused by conductive dust, rain or wetness.
For example: Devices in open-air plants and on construction machines.

Operating voltage (VDE: Rated voltage)

The level of a voltage that is specified by the manufacturer for a component, device or piece of equipment and to which the operating and performance parameters apply. The rated voltage depends on the connector's insulating material group and the respective creepage distances between the separate contacts, according to the specified pollution degree. By using empty modules and by differing the positioning of the contacts in the insulators, it is possible to influence the rated voltage considerably.

Devices are permitted to have more than one value for the rated voltage or to have a range of rated voltages) (see table F.4 in DIN EN60664-1:2007).

Nominal voltage

A suitable rounded voltage level, which is specified for a device by the manufacturer for labeling or identification. In these explanations, the term nominal voltage is used for the value of the output voltage specified by the power company or the manufacturer of the voltage source for classification of the overvoltage category.

Rated impulse voltage

Value of the impulse test voltage that is specified by the manufacturer for a device or a part thereof and that indicates the defined staying power of its accompanying insulation against transient (short-term, lasting a few milliseconds) overvoltages. The impulse test voltage here is the highest level of the impulse voltage of a defined shape and polarity that is not permitted to lead to any insulation disruptive discharge under defined conditions.

The rated impulse voltage depends on the clearance distance between the separate contacts, according to the specified pollution degree. By using empty modules and by differing the positioning of the contacts in the insulators, it is possible to influence the rated impulse voltage considerably (see table F.2 in DIN EN60664-1:2007).

In the most recent version of DIN EN 60664-1:2009, resources that are not connected directly to the low voltage supply should be designed for the minimum clearance distance according to the possible continuous voltage, the temporary overvoltages or the periodic peak voltage (see table F.7 in DIN EN 60664-1:2007).

Impulse test voltage / power-frequency test voltage

Highest value of the impulse voltage of a defined shape and polarity that is not permitted to lead to any insulation disruptive discharge or sparkover under defined conditions.

Clearance distance

Shortest distance between two conductive parts, through the air.

Creepage distance

Shortest distance between two conductive parts, along the surface of an insulating material. The creepage distance is influenced by the pollution degree used.

Test voltage

The connector's electric strength is tested to the standard according to the specified rated impulse voltage by applying the test voltage (impulse test voltage or power-frequency test voltage according to table F.5) over a defined time period.

DIN EN 60664-1: Table F.5 – Test voltages for testing clearance distances at different altitudes

(The voltage levels are valid only to verify the clearance distances)

Rated impulse voltage	Test impulse voltage		
	At sea level (NN)	at 200 m elevation	at 500 m elevation
\hat{u} kV	\hat{u} kV	\hat{u} kV	\hat{u} kV
0.33	0.357	0.355	0.350
0.5	0.541	0.537	0.531
0.8	0.934	0.920	0.899
1.5	1.751	1.725	1.685
2.5	2.920	2.874	2.808
4.0	4.923	4.874	4.675
6.0	7.385	7.236	7.013
8.0	9.847	9.648	9.950
12.0	14.770	14.471	14.025

Conversions AWG – Cross Section (AWG = American Wire Gauge)

The AWG system describes the cross section of a wire using a gauge number for every 26% increase in conductor cross section. With larger wire diameters, the AWG gauge numbers decrease; as the wire sizes increase, the AWG gauge numbers decrease. **This is only valid for solid conductors.**

Most wires are made with **stranded conductors**. Compared to solid conductors stranded wires offer higher durability, higher flexibility and better performance under bending and vibration.

Stranded wires are made from wires with smaller gauge sizes (higher AWG gauge number). The AWG gauge number of the stranded wire is equal to that of a solid conductor of the same size wire. The cross section of the stranded conductor is the sum of cross sections of the single conductors.

For example, a AWG-20 stranded wire of 7 AWG-28 conductors has a cross section of 0.563 mm²; an AWG-20 stranded wire with 19 AWG-32 conductors has a cross section of 0.616 mm².

Conversion table AWG/mm²

AWG	Circular wire				
	Diameter		Cross section mm ²	Weight kg/km	Max. resistance Ω/km
	Inch	mm			
10 (1)	0.1020	2.5900	5.2700	47.000	3.45
10 (37/26)	0.1109	2.7500	4.5300	43.600	4.13
12 (1)	0.0808	2.0500	3.3100	29.500	5.45
12 (19/25)	0.0895	2.2500	3.0800	28.600	6.14
12 (37/28)	0.0858	2.1800	2.9700	26.300	6.36
14 (1)	0.0641	1.6300	2.0800	18.500	8.79
14 (19/27)	0.0670	1.7000	1.9400	18.000	9.94
14 (37/30)	0.0673	1.7100	1.8700	17.400	10.50
16 (1)	0.0508	1.2900	1.3100	11.600	13.94
16 (19/29)	0.0551	1.4000	1.2300	11.000	15.70
18 (1)	0.0403	1.0200	0.8200	7.320	22.18
18 (19/30)	0.0480	1.2200	0.9600	8.840	20.40
20 (1)	0.0320	0.8130	0.5200	4.610	35.10
20 (7/28)	0.0366	0.9300	0.5600	5.150	34.10
20 (19/32)	0.0384	0.9800	0.6200	5.450	32.00
22 (1)	0.0252	0.6400	0.3240	2.890	57.70
22 (7/30)	0.0288	0.7310	0.3540	3.240	54.80
22 (19/34)	0.0307	0.7800	0.3820	3.410	51.80
24 (1)	0.0197	0.5000	0.1960	1.830	91.20
24 (7/32)	0.0230	0.5850	0.2270	2.080	86.00
24 (19/36)	0.0252	0.6400	0.2400	2.160	83.30
26 (1)	0.1570	0.4000	0.1220	1.140	147.00
26 (7/34)	0.0189	0.4800	0.1400	1.290	140.00
26 (19/38)	0.0192	0.4870	0.1500	1.400	131.00
28 (1)	0.0126	0.3200	0.0800	0.716	231.00
28 (7/36)	0.0150	0.3810	0.0890	0.813	224.00
28 (19/40)	0.0151	0.3850	0.0950	0.931	207.00
30 (1)	0.0098	0.2500	0.0506	0.451	374.00
30 (7/38)	0.0115	0.2930	0.0550	0.519	354.00
30 (19/42)	0.0123	0.3120	0.0720	0.622	310.00
32 (1)	0.0080	0.2030	0.0320	0.289	561.00
32 (7/40)	0.0094	0.2400	0.0350	0.340	597.10
32 (19/44)	0.0100	0.2540	0.0440	0.356	492.00
34 (1)	0.0063	0.1600	0.0201	0.179	951.00
34 (7/42)	0.0083	0.2110	0.0266	0.113	1,491.00
36 (1)	0.0050	0.1270	0.0127	0.072	1,519.00
36 (7/44)	0.0064	0.1630	0.0161	0.130	1,322.00
38 (1)	0.0040	0.1000	0.0078	0.072	2,402.00
40 (1)	0.0031	0.0800	0.0050	0.043	3,878.60
42 (1)	0.0028	0.0700	0.0038	0.028	5,964.00
44 (1)	0.0021	0.0540	0.0023	0.018	8,660.00

Source: Gore & Associates, Pleinfeld

Principles of Current Carrying Capacity

Derating measurement procedure (DIN EN 60512-5-2:2002)

Structure of the basis current carrying capacity curve

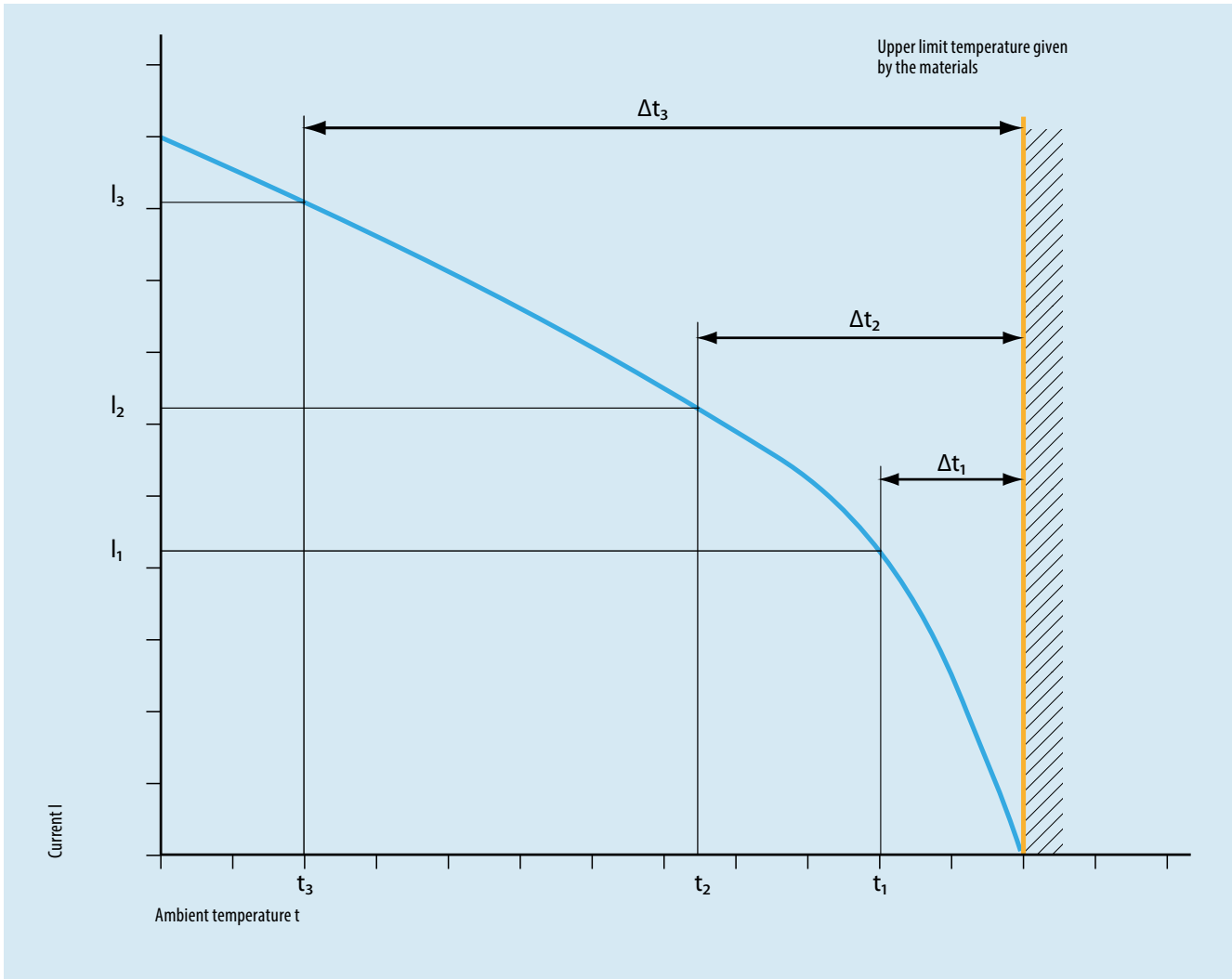

A connector's current carrying capacity is determined by measurement. It is determined by taking into account the self-heating due to Joule heat and the ambient temperature, and is limited by the thermal properties of the contact materials used; the upper limit temperatures of these materials should not be exceeded.

The relationship between current, the temperature increase caused as a result of the power dissipation at the contact resistor and the ambient temperature is depicted in a curve. The curve is drawn in a linear coordinate system with the current "I" as the ordinate and the temperature "t" as the abscissa. The upper limit temperature is used as a limit for the diagram.

In three measurements, the temperature rise due to Joule heat (Δt) is determined at different currents in at least three connectors and the points determined in this process are connected into a parabolic basis curve.

The corrected current carrying capacity curve (derating curve) can be derived from the basis curve. The safety factor ($0.8 \times I_n$) can be used to give consideration to such values as manufacturing tolerances as well as uncertainties in the temperature measurement and in the measurement setup.

Current Load

The heating in multi-position connectors and cables is greater than the heating in single contacts. A **reduction factor** is therefore used in the calculation. There is no direct regulation for connectors in this regard. For this reason, the reduction factors for multi-wire cables as given in DIN 57 298 Part 2 / VDE 0298 Part 2 are used. The reduction factor applies for 5 or more loaded wires (cf. also DIN 41 640, Part 3).

The nominal current is the current intensity that leads to a contact temperature increase of 45 K in a contact. Nominal current refers to individually loaded contacts.

Example

A cable with 24 wires (24 positions) is used. The nominal cross-section of a wire is 6 mm².

A reduction factor (e.g. cable laid in air) of 0.4 is to be applied for the load reduction depending on the number of loaded cable wires.

According to the current carrying capacity, a 6 mm² Cu line can be used for 44 amperes.

The 24 positions cable can accordingly be loaded with a max. 17.6 A/wire (0.4 × 44 A).

Technical information / application examples

Example: Termination cross-sections

The current load curve for the contact diameter 3 mm refers to a termination cross-section of 6 mm². If the contact (∅ 3 mm) is connected to a cable with a cross-section of 2.5 mm², the max. permissible current intensity is limited by the conductor. To determine the max. permissible current intensity, a smaller contact with corresponding cross-section is then selected.

Contact ∅ 3 mm with 6 mm²

= max. nominal single contact current load 50 A

Contact ∅ 3 mm with 2.5 mm² (with ∅ 2 mm)

= max. nominal single contact current load 40 A

Reduction factors

Multi-wire cable with the conductor cross-sections from 1.5 to 10 mm² when laid in air.

Cable in air

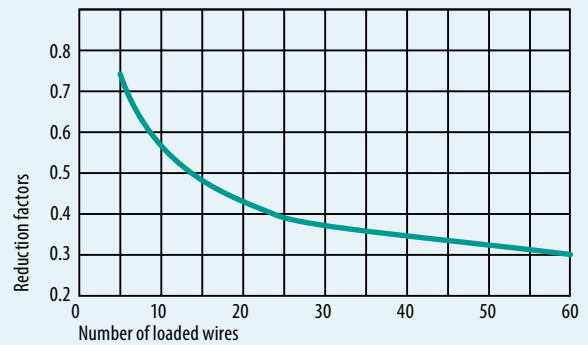

Load reduction factors

For plastic cable from 1.5 to 10 mm² when laid in air.

Number of loaded wires	Reduction factors
5	0.75
7	0.65
10	0.55
14	0.50
19	0.45
24	0.40
40	0.35
61	0.30

Line Current Load

Laid	Exposed in air	Or on surfaces		
	Single-wire lines PVC, PE, PUR, TPE heat resistant	Multi-wire highly flexible lines for hand-held devices, wire/sheath cold-resistant, PVC insulated		Multi-wire movable lines standard program harmonized series
Number of loaded wires	1	2	3	2 or 3
Nominal cross-section of copper conductor in mm ²	Current load in A			
0.14	3			2
0.25	5			4
0.34	8			6
0.5	12	3	3	9
0.75	15	6	6	12
1	19	10	10	15
1.5	24	16	16	18
2.5	32	25	20	26
4	42			36
6	54			44
10	73			62
16	98			81
25	129			108
35	158			135
50	198			168
Current load according to	DIN VDE 0100 T.523 1981-06 group 3	following the principles of HD21S2T.1 based on H05VV-F VDE 0281		DIN VDE 0100T523 1981-06 group 2 DIN VDE 0298 T4 table 9

Permissible loads on insulated lines up to 30°C
Ambient temperature following the principles of
VDE 0100 part 523, 0298 part 4 and 0891 part 1.

Current load, flexible lines with nominal voltages up to
1,000V at ambient temperature +30°C.

Technical Terms / Definitions / Information

Basis curve for ODU DOCK

Current carrying capacity curve for connectors as determined by measurement according to the measurement procedure described in DIN EN 60512-5-2:2002 depending on the permissible limit temperature of the materials.

Clearance distance

The shortest distance, measured as a thread measure, between two live metallic parts in the air.

Connector = ODU DOCK

A component that allows the connection of electrical conductors and that is intended to set up connections to a suitable mating component and/or to such separate connections. Connectors are operating materials that are not permitted to be inserted or separated when used as intended (when energized or loaded). The connector consists of the connector housing and the contact element.

Connectors, fixed (receptacles)

Are intended for attachment to racks, slide-in modules, devices or walls.

Connectors, loose (plugs)

Are intended for attachment to free ends of moving lines and cables.

Contact resistance

Total resistance from termination to termination. The contact resistance here is considerably less than the volume resistance. The values given are average values.

Creepage distances

Shortest distances between live parts on the surface of insulation bodies. All elevations and depressions in the insulation body are taken into account as far as specified minimum dimensions are available.

Crimp area

The area of the crimp barrel in which the crimp connection is made by compressive deformation or compressive forming of the sleeve around the conductor.

Current carrying capacity (nominal current and max. continuous current)

The information refers to sufficiently dimensioned connection cable in accordance with DIN VDE 0295 (DIN EN 60228) in class 5, so that no stronger temperature increase is caused from here. The specified temperature increase takes place through the contact. The information provided refers to average values.

Derating curve

The corrected current carrying capacity curve, derived from the established basis curve (0.8 x measured current). It takes into consideration production spreads as well as uncertainties in the temperature measurement and the measurement setup.

Derating measurement procedure (DIN EN 60512-5-2)

Measurement procedure for determining the current carrying capacity of connectors, taking the maximum permissible limit temperature into consideration.

Insertion or withdrawal force

Force that, without the influence of a coupling or locking device, is required for completely inserting or withdrawing pluggable components.

Insulator

Part of a connector, usually identical to the contact carrier.

Lubrication

The contacts are pre-lubricated at the factory.

Mating cycles

Mechanical activation of connectors and plug-and-socket devices by insertion and withdrawal. A mating cycle consists of an insertion and withdrawal step.

Max. continuous current

The metrologically determined current intensity at room temperature (approx. 20°C) that leads to a rise in the contact temperature to the limit temperature.

Nominal current

The metrologically determined current intensity that leads to an increase of 45° Kelvin in the contact temperature. The nominal current is determined according to the derating measurement procedure (DIN EN 60512-5-2:2002). The information refers to the basis curve.

Nominal single contact current load

The current carrying capacity with which each single contact can be separately loaded.

Nominal voltage

The voltage stated for a connector by the manufacturer; this is used as a reference for the operating and performance characteristics.

Operating temperature

for the ODU DOCK: -40°C to +100°C
(-40 to 212°F).

Operating voltage

The nominal voltage of the current source for which the connector is intended for use. The operating voltage is not permitted to be greater than the connectors nominal voltage.

Plug device

Operating materials that are permitted to be inserted or separated during the intended use (when energized or electrically charged).

Rated current (IEC 61984)

The metrologically determined current intensity that leads to an increase of 45° Kelvin in the contact

temperature. The current is determined according to the derating measurement procedure (DIN EN 60512-5-2:2002) and is derived from the basis curve

Rated voltage

The voltage according to which the connectors are dimensioned and to which the particular operating properties are related.

Reference voltage

The standardized voltage (VDE 0110 or DIN EN 60664-1) for which a connectors insulation is dimensioned.

Solder connections

Termination technology in which a melted added metal (solder), whose melting temperature is less than that of the base metals to be connected, is used to join two metallic materials.

Surge current

One-time power pulse current with a load period of 10 ms.

Termination cross-section

The specified cross-sections correspond to DIN VDE 0295 (DIN EN 60228) Class 5.

Termination technologies

Methods for connecting the lines to the electro-mechanical components, such as solderless connections in accordance with DIN EN 60352: crimp, press-fit connection, etc. or solder connection.

Test voltage

The voltage that a connector can withstand under defined conditions without disruptive discharge or sparkover.

Wire

Conductor with its insulation, including any guiding layers that may be present.

Cables or lines can have one or more wires.

Suitable safety precautions must be taken in order to ensure that personnel do not come into contact with live conductors during installation and operation. All entries were reviewed with maximum care before this catalogue was printed.

ODU reserves the right to make changes in accordance with the current state of the art without advance notice, and without being obligated to provide replacement deliveries or to continue production of older designs.

Company Information

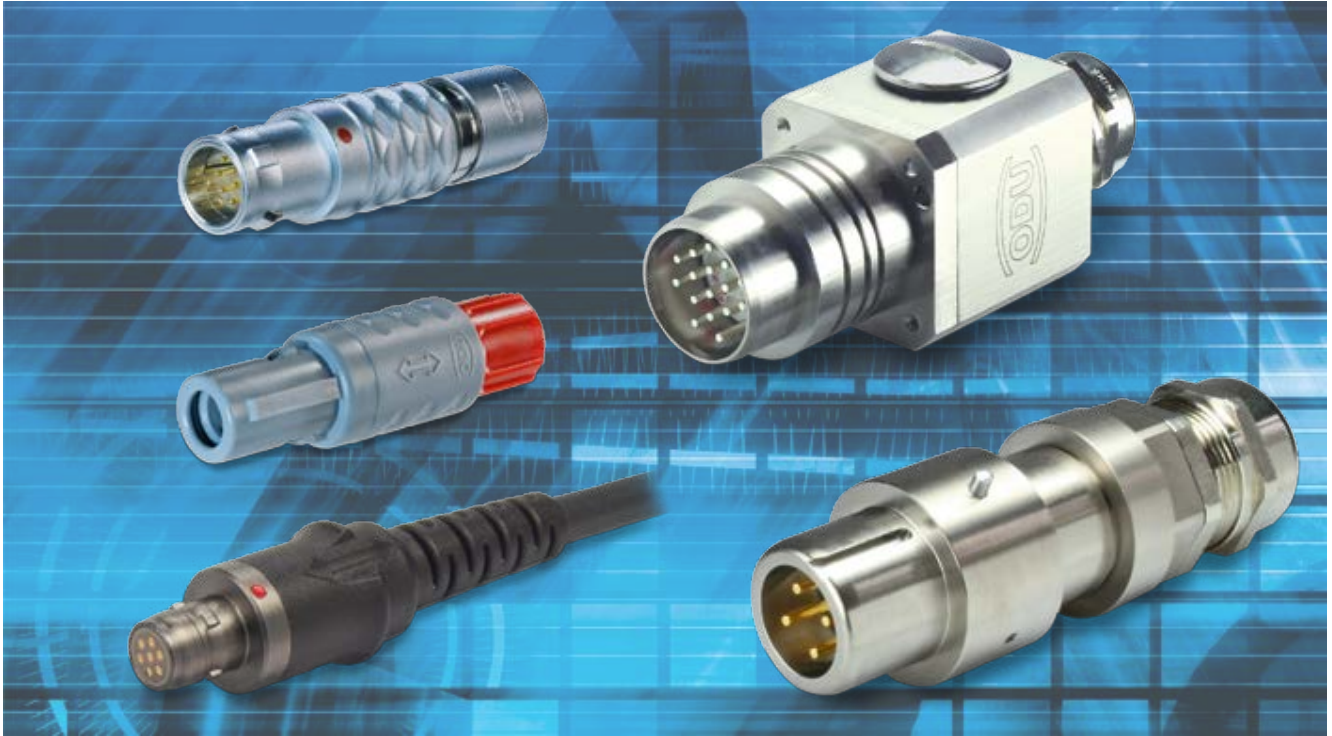

Quality Management and Certifications

ODU has had a powerful quality management system in place for years. ODU has been successfully certified to DIN EN ISO 9001 since 1994. In addition, the automotive sector of the company group is certified to ISO/TS 16949.

The certification process was carried out by the internationally active BVQI (Bureau Veritas Quality International) company.

ODU is also certified according to the medical standard ISO 13485:2003 + AC:2007.

Additional to this ODU is certified to DIN EN ISO 14001:2009 as well as to different certifications: VDE, UL, UL wiring harness, CSA, VG.

ODU-USA is registered with the DDTC and able to complete ITAR restricted manufacturing projects





Your Partner in Many Application Areas

ODU stands for quality, flexibility and reliability. This is why customers working in many application areas rely on ODU products in markets such as the following:

- Medical
- Industrial
- Measuring and testing
- Military and security
- Energy
- eMobility.

The Complete ODU Product Range



Everything From One Source

Each connection needs its individual cable. Make no compromises when it comes to the quality of the complete connection system. ODU gives you the complete system solution from one source, with no intermediary suppliers.

Cable assembly is a very complex subject. It requires equal measures of expertise in the areas of connectors, cables and assembly. ODU meets all these requirements in full.

Our competent assembly team tests the complete system according your specifications. Our assembly service promises you the same quality found in our connectors – without compromises.

ODU offers you all from one source

- 100% final inspections
- Production in clean room acc. to EN ISO14644-1 possible
- Automatic processes (cutting, stripping, attaching)
- Extrusion possible with a hot-melt and high pressure/temperature process
- Ultrasound welding
- EMC compatible assembly
- Application specific labeling
- Widest range of potting possibilities for sealed systems
- Extruded cable crossovers.

Advantages for the customer

- Modern manufacturing facilities in Mühldorf (Germany), Shanghai (China) and Sibiu (Romania)
- Reliability thanks to our company-wide quality strategy
- Products with durability and functional reliability
- Production according to UL (file: E333666) possible
- Inspections, such as crimp force monitoring, during production.



Application Specific Connectors



Innovative, dynamic markets call for innovative connectors.

As an expert for special applications and requirements, we develop forward-looking, appropriate connectors attuned to your needs!

In spite of the global trend toward standardized connectors, there are always applications that call for an application specific solution. We accept this challenge and

develop innovative products for our customers based on our many years of extensive know-how, our creativity and, not least, our high level of vertical integration. Technology access and technology mastery, combined with intensive cooperation with the user, form the basis for achieving success together.

Design-to-cost is joined by design-for-application for the customer's benefit.



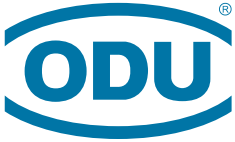

A PERFECT ALLIANCE.

ODU GROUP WORLDWIDE

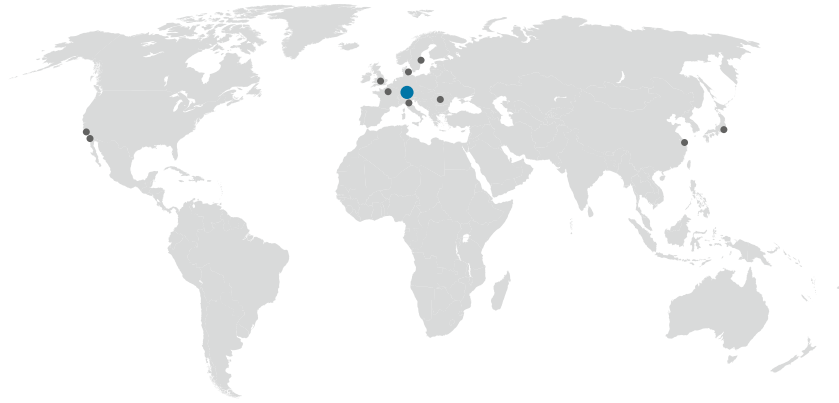

HEADQUARTERS

ODU GmbH & Co. KG

Pregelstraße 11, 84453 Mühldorf a. Inn, Germany
Phone: +49 8631 6156-0, Fax: +49 8631 6156-49, E-mail: zentral@odu.de

SALES SUBSIDIARIES

ODU Denmark ApS

Phone: +45 2233 5335
E-mail: sales@odu-denmark.dk
www.odu-denmark.dk

ODU Japan K.K.

Phone: +81 3 6441 3210
E-mail: sales@odu.co.jp
www.odu.co.jp

ODU-UK Ltd.

Phone: +44 330 002 0640
E-mail: sales@odu-uk.co.uk
www.odu-uk.co.uk

ODU France SARL

Phone: +33 1 3935-4690
E-mail: odu@odu.fr
www.odu.fr

ODU Scandinavia AB

Phone: +46 176 18262
E-mail: sales@odu.se
www.odu.se

ODU-USA, Inc.

Phone: +1 805 484-0540
E-mail: sales@odu-usa.com
www.odu-usa.com

ODU Italia S.R.L.

Phone: +39 331 8708847
E-mail: sales@odu-italia.it
www.odu-italia.it

ODU (Shanghai)

International Trading Co., Ltd.
Phone: +86 21 58347828-0
E-mail: oduchina@odu.com.cn
www.odu.com.cn

Further information and specialized representatives can be found at:

www.odu-connectors.com/contact

PRODUCTION AND LOGISTICS SITES

Germany Otto Dunkel GmbH
China ODU (Shanghai) Connectors Manufacturing Co. LTD
Mexico ODU Mexico Manufacturing S.R.L. de C.V.
Romania ODU Romania Manufacturing S.R.L.
USA ODU-USA, Inc.
ODU North American Logistics



Simply scan the QR code
to download the entire brochure.

KOMMA Werbeagentur | D-84453 Mühldorf a. Inn

ODU00CK/B_0448/E