

MICRO 360[®] Plastic



Micro Circular Solder Cup (Type SS)

Electrical-Mechanical Specifications

- Operating Temperature: _____ -55°C to 125°C (200°C w/ High Temp Epoxy)
- Dielectric Withstand Voltage: _____ 600 VAC RMS @sea level
- Contact Resistance: _____ 26 milliohms(65 mV) Max @2.5 Amps
- Current Rating: _____ 3 Amps per contact
- Durability: _____ >2000 Mating Cycles min
- Insulation Resistance: _____ 5000 megohms @ 500 VDC
- Shock: _____ 50 g's with no discontinuities > 1 microsecond
- Vibration: _____ 20 g's with no discontinuities > 1 microsecond
- Thermal Vacuum Outgassing (Space Class): _____ 1.0% max TML, 0.03% max CVCM
- Mating/Unmating Force: _____ 3 oz (85 g) typical per contact

Material Specifications

- Contact: _____ Copper Alloy per MIL-DTL-83513
- Contact Finish: _____ Gold per ASTM B488, Type II, Class 1.27, Code C
Over Nickel Underplate
- Insulator: _____ Thermoplastic per MIL-M-24519

Plastic - Pin - Solder Cup

MCP-SS

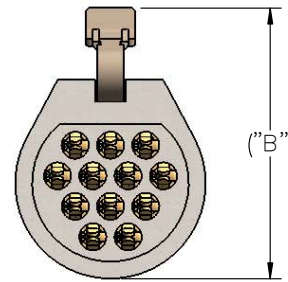
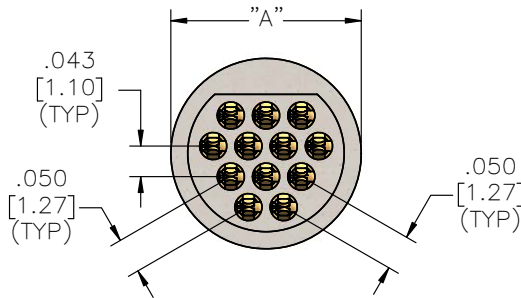
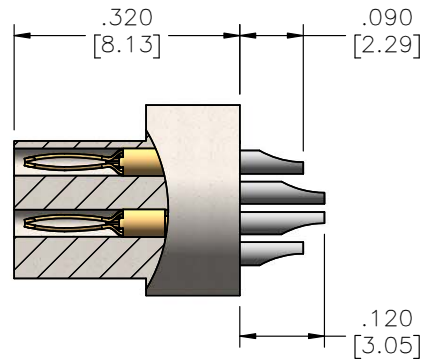

English (IN) Metric (MM)

Part #	Contacts	A	A
A22000-001	5	0.220	5.59
A22004-001	12	0.270	6.86
A22032-001	16	0.325	8.26
A22012-001	27	0.395	10.03
A22394-001	39	0.445	11.30

LATCHING OPTION

English (IN) Metric (MM)

Part #	Contacts	B	B
A22027-001	5	0.310	7.87
A22066-001	7	0.340	8.64
A22029-001	12	0.380	9.65
A22038-001	16	0.410	10.41
A22031-001	27	0.480	12.19

Plastic - Socket - Solder Cup

MCS-SS

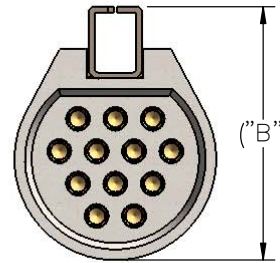
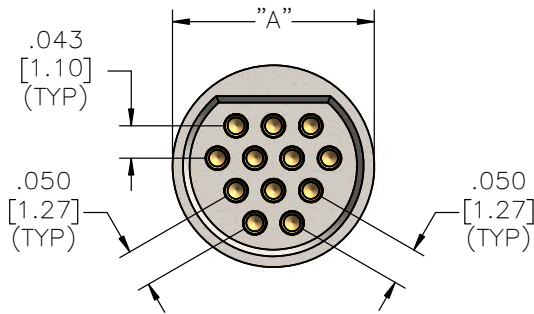
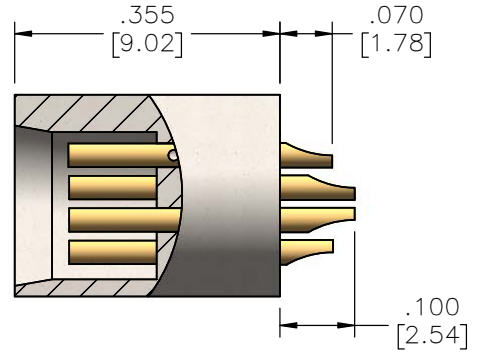
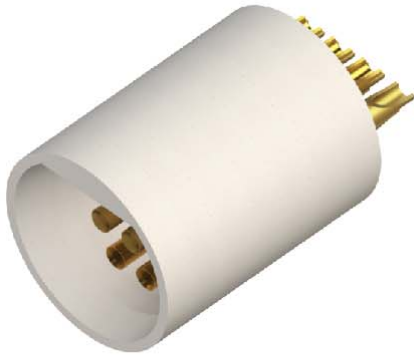





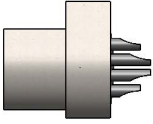

Part #	Contacts	English	Metric
		(IN)	(MM)
A22001-001	5	A	A
A22005-001	12	0.220	5.59
A22033-001	16	0.270	6.86
A22013-001	27	0.325	8.26
A22402-001	39	0.395	10.03
		0.445	11.30

LATCHING OPTION

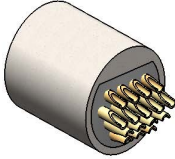
Part #	Contacts	English	Metric
		(IN)	(MM)
A22026-001	5	B	B
A22067-001	7	0.260	6.60
A22028-001	12	0.300	7.62
A22039-001	16	0.340	8.64
A22031-001	27	0.370	9.40
		0.440	11.18

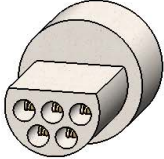
MICRO CIRCULAR SOLDER CUP (TYPE SS)

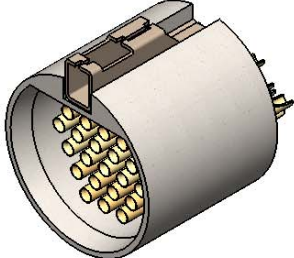
Series	# of Contacts	Termination Type	Options
MC	5	SS: Solder Cup	LT
	7		Latch
Male (P - Pin)	12		
	16		CLIP
	27		Locking Clip
	39		
Female (S - Socket)			RH
			RoHS COMPLIANT
			
			
		EXAMPLE: MCS-27-SS-LT	