

# MICRO 360<sup>®</sup> Plastic

**Micro Circular Straight Thru-Hole Tail (Type DD)**

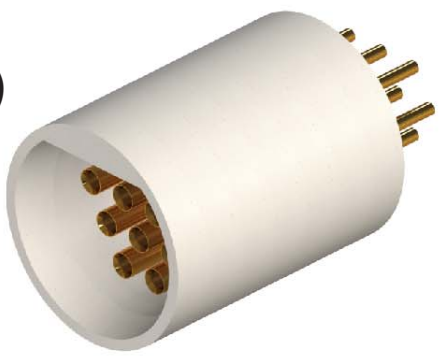

## Electrical-Mechanical Specifications

- Operating Temperature: \_\_\_\_\_ -55°C to 125°C (200°C w/ High Temp Epoxy)
- Dielectric Withstand Voltage: \_\_\_\_\_ 600 VAC RMS @sea level
- Contact Resistance: \_\_\_\_\_ 26 milliohms(65 mV) Max @2.5 Amps
- Current Rating: \_\_\_\_\_ 3 Amps per contact
- Durability: \_\_\_\_\_ >2000 Mating Cycles min
- Insulation Resistance: \_\_\_\_\_ 5000 megohms @ 500 VDC
- Shock: \_\_\_\_\_ 50 g's with no discontinuities > 1 microsecond
- Vibration: \_\_\_\_\_ 20 g's with no discontinuities > 1 microsecond
- Thermal Vacuum Outgassing (Space Class): \_\_\_\_\_ 1.0% max TML, 0.03% max CVCM
- Mating/Unmating Force: \_\_\_\_\_ 3 oz (85 g) typical per contact

## Material Specifications

- Contact: \_\_\_\_\_ Copper Alloy per MIL-DTL-83513
- Contact Finish: \_\_\_\_\_ Gold per ASTM B488, Type II, Class 1.27, Code C  
 Over Nickel Underplate
- Insulator: \_\_\_\_\_ Thermoplastic per MIL-M-24519

# Plastic - Pin - Straight Tail

## MCP-DD

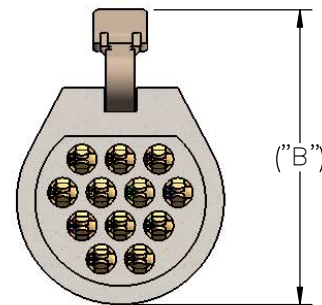
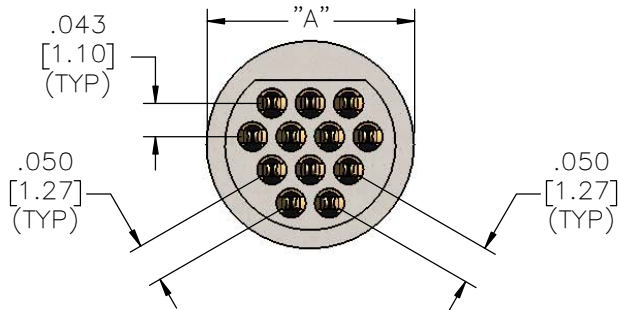
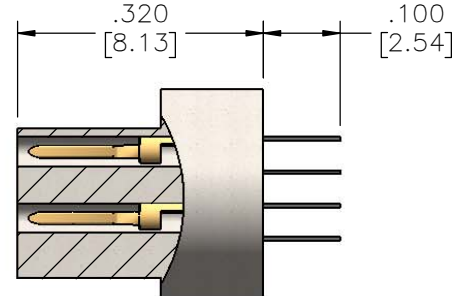
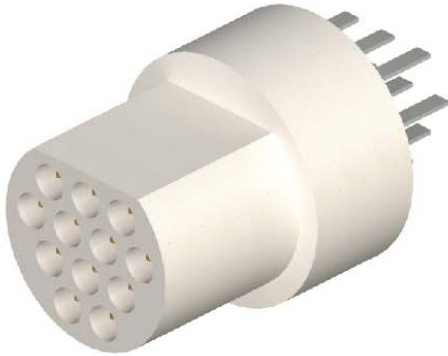

**English (IN)    Metric (MM)**

Part #	Contacts	A	A
A22015-001	5	0.220	5.59
A22017-001	12	0.270	6.86
A22036-001	16	0.325	8.26
A22019-001	27	0.395	10.03
A22392-001	39	0.445	11.30

LATCHING OPTION

**English (IN)    Metric (MM)**

Part #	Contacts	B	B
A22044-001	5	0.310	7.87
A22068-001	7	0.340	8.64
A22046-001	12	0.380	9.65
A22050-001	16	0.410	10.41
A22048-001	27	0.480	12.19

# Plastic - Socket - Straight Tail

MCS-DD

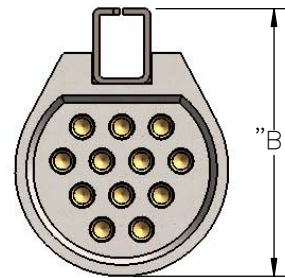
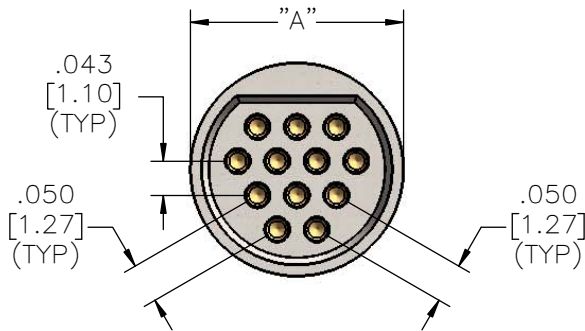
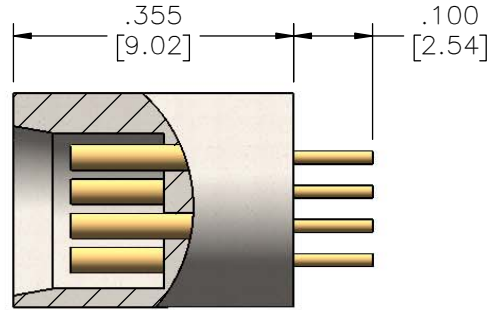
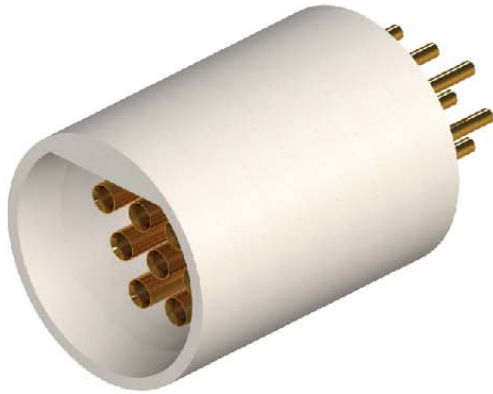





Part #	Contacts	English	Metric
		(IN)	(MM)
A22014-001	5	A	A
A22016-001	12	0.220	5.59
A22037-001	16	0.270	6.86
A22018-001	27	0.325	8.26
A22018-001	27	0.395	10.03
A22400-001	39	0.445	11.30

LATCHING OPTION

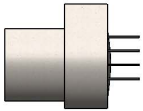
Part #	Contacts	English	Metric
		(IN)	(MM)
A22045-001	5	B	B
A22069-001	7	0.310	7.87
A22047-001	12	0.340	8.64
A22047-001	12	0.380	9.65
A22051-001	16	0.410	10.41
A22049-001	27	0.480	12.19

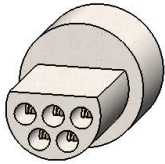
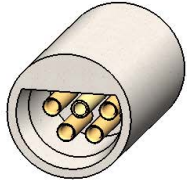
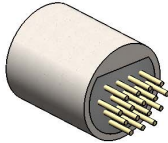
# MICRO CIRCULAR STRAIGHT THRU-HOLE TAIL (TYPE DD)

Series	# of Contacts	Termination Type	Options	
<b>MC</b>	<b>5</b>	<b>DD: Straight Thru-Hole</b>	<b>LT</b>	
	<b>7</b>		Latch	
Male (P - Pin)	<b>12</b>			
	<b>16</b>			
	<b>27</b>			
	<b>39</b>		<b>RH</b>	
Female (S - Socket)			RoHS COMPLIANT	
				

**EXAMPLE:**  
MCP-16-DD-LT

