

Clarke & Severn Electronics  
Ph +612 9482 1944  
Email sales@clarke.com.au  
www.clarke.com.au  
www.cseonline.com.au

 Mini-Circuits®



  
2019

# TEST SOLUTIONS GUIDE





# TABLE OF CONTENTS



**4**  
MODULAR TEST SYSTEMS



**10**  
MECHANICAL SWITCH MATRICES



**12**  
SOLID STATE SWITCH MATRICES



**14**  
PROGRAMMABLE ATTENUATORS

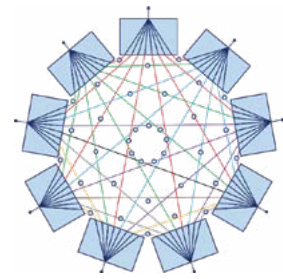

**18**  
MESH NETWORK TEST SYSTEMS

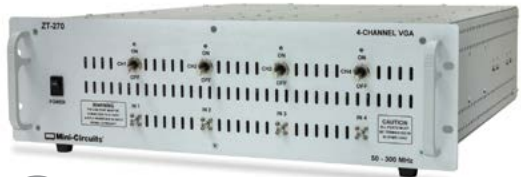

**22**  
INSTRUMENTATION AMPLIFIERS



**24**  
NxM SWITCH MATRICES



**30**  
SIGNAL GENERATION,  
MEASUREMENT & CONTROL



**32**  
HIGH POWER TEST SYSTEMS



**34**  
PANEL MOUNTED STRUCTURES



**38**  
SIGNAL DISTRIBUTION



**42**  
CUSTOM SYSTEMS



# MODULAR TEST SYSTEMS



## HIGHLIGHTS

- Your choice of rack-mount or bench-top structures
- Customizable front-panel layout
- USB and Ethernet control interfaces
- User-friendly GUI and API included
- **2 weeks or sooner!**

## RCM CONFIGURATION TOOL

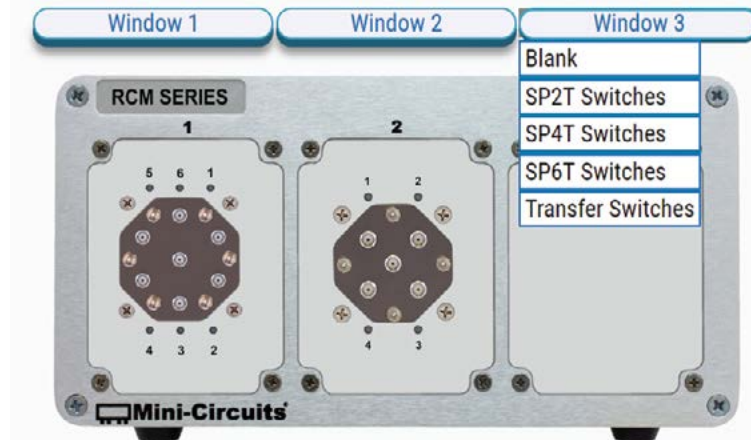

Window	Window Contents	Model Number(s)	Frequency
1	One SP6T Switch	MSP6TA-12+	DC – 12 GHz
2	One SP4T Switch	MSP4TA-18+	DC – 18 GHz
3	Blank Window	None	None

## RCM-SERIES



Module	
Window 1	MSP8TA-12D+
Window 2	MSP8TA-12D+



Module	
Window 1	MSP4TA-18+
Window 2	MSP2TA-18XL+
Window 3	Dual MTS-18XL-B+

## RCM MODEL EXAMPLES

Module	Window 1	Window 2	Window 3
RCM-1SP8T-12	SP8T		Blank
RCM-2SP8T-12	SP8T		SP8T
RCM-3SP4T-18	SP4T	SP4T	SP4T
RCM-202	SP4T	1SPDT	SP4T
RCM-203	SP6T12	SP4T	Blank
RCM-204	SP4T	1SPDT	Blank
RCM-205	1SPDT	2MTS	1SPDT
RCM-206	SP6T26	SP4T26	SP6T26
RCM-207	SP4T	2SPDT	SP4T
RCM-208	SP4T	1SPDT	2SPDT
RCM-209	SP6T12	SP6T12	2SPDT

# ZTM CONFIGURATION TOOL

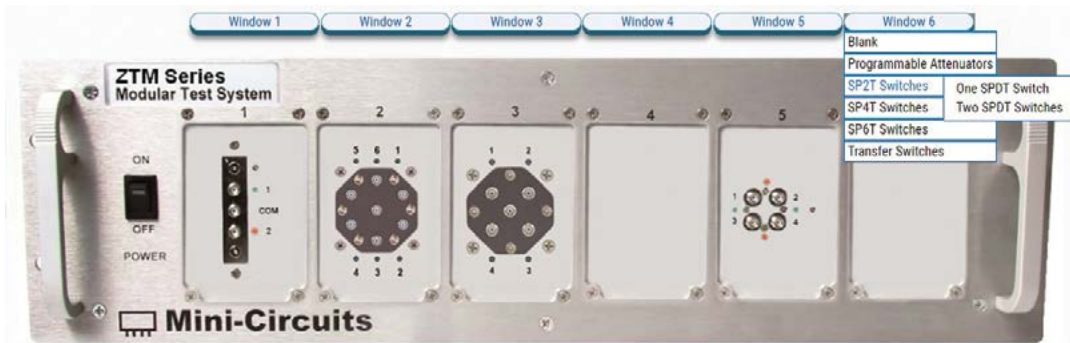

Window	Window Contents	Model Number(s)	Frequency
1	One SPDT Switch	MSP2TA-18XL+	DC to 18 GHz
2	One SP6T Switch	MSP6TA-12+	DC to 12 GHz
3	One SP4T Switch	MSP4TA-18	DC to 18 GHz
4	Blank Window	None	None
5	One Transfer Switch	MTS-18XL+	DC to 18 GHz
6	Blank Window	None	None

## ZTM-SERIES

Module	
Window 1	MSP4TA-18+
Window 2	MSP4TA-18+
Window 3	Dual MTS-18XL-B+
Window 4	Dual MSP2TA-18XL+
Window 5	MSP4TA-18+
Window 6	MSP4TA-18+



## ZTMR-1 SERIES

Module	
Window 1	Dual MSP2TA-18XL+
Window 2	Dual MSP2TA-18XL+
Window 3	Dual MSP2TA-18XL+
Window 4	MSP4TA-18+
Window 5	Dual MSP2TA-18XL+



# ZTM MODEL EXAMPLES

Model Name	Window 1	Window 2	Window 3	Window 4	Window 5	Window 6
ZTM-4SP8T-12	SP8T	SP8T	SP8T	SP8T	Blank	Blank
ZTM-5SP4T	SP4T	SP4T	SP4T	SP4T	SP4T	Blank
ZTM-6SP4T-40	SP4T40	SP4T40	SP4T40	SP4T40	SP4T40	SP4T40
ZTM-6SP6T-26	SP6T26	SP6T26	SP6T26	SP6T26	SP6T26	SP6T26
ZTM-10	2SPDT	SP4T	SP4T	2SPDT	2MTS	2SPDT
ZTM-11	SP4T	1SPDT	SP4T	SP4T	1SPDT	SP4T
ZTM-12	SP6T12	1MTS	SP4T	SP6T12	1SPDT	1SPDT
ZTM-13	2SPDT	2SPDT	SP6T12	SP6T12	2SPDT	2SPDT
ZTM-14	SP4T	SP4T	SP4T	SP4T	SP4T	SP4T
ZTM-15	SP6T12	SP6T12	SP6T12	SP6T12	SP6T12	SP6T12
ZTM-16	SP4T	1SPDT	SP4T	1SPDT	Blank	Blank
ZTM-46	SP6T12	SP6T12	SP6T12	SP6T12	SP6T12	2SPDT
ZTM-49	SP6T12	2SPDT	SP6T12	SP6T12	2SPDT	SP6T12
ZTM-51	SP6T12	SP6T12	SP4T	SP6T12	SP4T	Blank
ZTM-53	SP4T	SP4T	1SPDT	SP4T	SP4T	SP4T
ZTM-54	2SPDT	SP6T12	SP6T12	SP6T12	2SPDT	2SPDT
ZTM-57	SP6T12	R30	ZFL1000	SP6T12	R30	ZFL1000
ZTM-58	SP6T12	SP6T12	SP6T12	SP6T12	Blank	Blank
ZTM-59	SP6T12	Blank	SP6T12	SP6T12	Blank	SP6T12
ZTM-60	SP4T	SP4T	SP4T	2SPDT	R60	R90
ZTM-62	SP6T12	SP6T12	SP6T12	2SPDT	2SPDT	2SPDT
ZTM-63	R60R60	2SPDT	2MTS	SP6T12	SP6T12	2SPDT
ZTM-64	SP4T	SP4T	SP4T	2SPDT	SP4T	SP4T
ZTM-65	2SPDT	1MTS	SP4T	R110110	ZX10R14	ZX10R14
ZTM-66	Blank	1SPDT	SP6T12	SP6T12	1SPDT	Blank
ZTM-67	SP4T	SP4T	1SPDT	R120	Blank	Blank
ZTM-69	SP4T	Blank	SP4T	ZN2PD263	2MTS	Blank
ZTM-71	2SPDT	2SPDT	2SPDT	SP6T12	SP6T12	Blank
ZTM-73	1SPDT26	1SPDT26	1SPDT26	SP4T	SP4T	Blank
ZTM-74	SP6T12	2SPDT	SP6T12	SP6T12	SP6T12	SP6T12
ZTM-77	SP4T26	SP4T26	SP4T26	2SPDT26	SP4T26	SP4T26
ZTM-78	2SPDT26	2SPDT26	2MTS26	SP4T26	SP4T26	SP4T26
ZTM-79	R120120	SP6T12	SP6T12	SP6T12	Blank	Blank
ZTM-82	2SPDT	2SPDT	2SPDT	2SPDT	SP4T	SP4T
ZTM-83	SP4T	2SPDT	2SPDT	2SPDT	Blank	Blank
ZTM-84	SP6T12	SP6T12	SP6T12	SP4T	SP4T	2SPDT
ZTM-85	SP6T26	SP6T26	SP4T	SP4T	2SPDT	Blank
ZTM-86	SP6T18	SP6T18	SP6T18	SP6T18	2SPDT	Blank
ZTM-87	SP4T	SP6T12	1SPDT	SP6T12	Blank	Blank
ZTM-88	2MTS	2MTS	2MTS	2MTS	2MTS	Blank



# ZTM2 CONFIGURATION TOOL



## TOP ROW

Slot	Window Contents	Model Number(s)	Frequency
1	SP8T Switch	MSP8TA-12+	DC to 12 GHz
4	SP8T Switch	MSP8TA-12+	DC to 12 GHz
7	Blank Window	None	None
8	Transfer Switch	MTS-18XL+	DC to 18 GHz
9	Transfer Switch	MTS-18XL+	DC to 18 GHz
10	SP6T Switch	MSP6TA-12+	DC to 12 GHz
12	Blank Window	None	None

## BOTTOM ROW

Slot	Window Contents	Model Number(s)	Frequency
1	SPDT Switch	MSP2TA-18XL+	DC to 18 GHz
2	SP4T Switch	MSP4TA-18	DC to 18 GHz
4	SP8T Switch	MSP8TA-12+	DC to 12 GHz
7	Blank Window	None	None
8	Blank Window	None	None
9	2-Way Splitter	ZN2PD2-63-S+	350 to 6000 MHz
11	2-Way Splitter	ZN2PD2-63-S+	350 to 6000 MHz

## ZTM2-SERIES

Module		
Slot 1	Slot 2	Dual MSP2TA-18XL+
Slot 3	Slot 4	MSP6TA-12+
Slot 5	Slot 6	ZN2PD2-63-S+
Slot 7	Slot 8	ZN2PD2-63-S+
Slot 9	Slot 10	ZN2PD2-63-S+
Slot 11	Slot 12	ZN2PD2-63-S+
Slot 13	Slot 14	MSP6TA-12+
Slot 15	Slot 16	MSP6TA-12+
Slot 17	Slot 18	MSP6TA-12+
Slot 19	Slot 20	Dual MSP2TA-18XL+
Slot 21	Slot 22	MSP6TA-12+
Slot 23	Slot 24	Dual MSP2TA-18XL+



# ZTM2 MODEL EXAMPLES

Model Name	Row	Slot 1	Slot 2	Slot 3	Slot 4	Slot 5	Slot 6	Slot 7	Slot 8	Slot 9	Slot 10	Slot 11	Slot 12
ZTM2-1	1	SP4T	SPDT	SP4T	Blank	Blank	SP4T	SPDT	SP4T				
	2	SP4T	SPDT	SP4T	Blank	Blank	SP4T	SPDT	SP4T				
ZTM2-2	1	SPDT	SPDT	SP6T12	SPDT	SPDT	SPDT	SPDT	SP6T12	SPDT	SPDT		
	2	SPDT	SPDT	SP6T12	SPDT	SPDT	SPDT	SPDT	SP6T12	SPDT	SPDT		
ZTM2-3	1	Blank	Blank	SP6T40	Blank	Blank	Blank	SP6T40	SP4T40				
	2	Blank	SPDT	SPDT	SPDT	SPDT	SPDT	SPDT	SPDT	SPDT	SPDT	SPDT	SPDT
ZTM2-4	1	SPDT	SPDT	SPDT	SPDT	SPDT	SPDT	SPDT	SPDT	SPDT	SPDT	Blank	Blank
	2	SP6T12	SP6T12	SP6T12	SP6T12	SP6T12	SP6T12	Blank	Blank	Blank	Blank	Blank	Blank
ZTM2-5	1	Blank	Blank	SP6T12	SP4T	SP4T	SP6T12	Blank	Blank	Blank	Blank	Blank	Blank
	2	SP8T	SP8T	SP8T	SP8T	SP8T	SP8T	SP8T	SP8T	SP8T	SP8T	SP8T	SP8T
ZTM2-6SP8T-12	1	SP8T	SP8T	SP8T	SP8T	SP8T	SP8T	SP8T	SP8T	SP8T	SP8T	SP8T	SP8T
	2	SP8T	SP8T	SP8T	SP8T	SP8T	SP8T	SP8T	SP8T	SP8T	SP8T	SP8T	SP8T
ZTM2-8SP8T-12	1	SP8T	SP8T	SP8T	SP8T	SP8T	SP8T	SP8T	SP8T	SP8T	SP8T	SP8T	SP8T
	2	SP8T	SP8T	SP8T	SP8T	SP8T	SP8T	SP8T	SP8T	SP8T	SP8T	SP8T	SP8T
ZTM2-12SP6T-12	1	SP6T12	SP6T12	SP6T12	SP6T12	SP6T12	SP6T12	SP6T12	SP6T12	SP6T12	SP6T12	SP6T12	SP6T12
	2	SP6T12	SP6T12	SP6T12	SP6T12	SP6T12	SP6T12	SP6T12	SP6T12	SP6T12	SP6T12	SP6T12	SP6T12
ZT-251	1	SP8T	SP8T	SP6T12	SP8T	SP8T	SP6T12	SP8T	SP8T	SP8T	SP8T	SP8T	Blank
	2	SP8T	SP8T	SP8T	SP8T	SP8T	SP6T12	SP8T	SP8T	SP8T	SP8T	SP8T	Blank
ZT-252	1	SPDT	SPDT	SP6T12	2-Way Splitter	2-Way Splitter	2-Way Splitter	2-Way Splitter	2-Way Splitter	2-Way Splitter	2-Way Splitter	2-Way Splitter	2-Way Splitter
	2	SP6T12	SP6T12	SP6T12	SP6T12	SP6T12	SP6T12	SP6T12	SP6T12	SP6T12	SP6T12	SP6T12	SP6T12
ZTM-203	1	SP6T40	SP6T40	SP6T40	SP6T40	SP6T40	SP6T40	SP6T40	SP6T40	SP6T40	SP6T40	SP6T40	SP6T40
	2	SP6T40	SP6T40	SP6T40	SP6T40	SP6T40	SP6T40	SP6T40	SP6T40	SP6T40	SP6T40	SP6T40	SP6T40
ZTM-204	1	SP6T40	SP6T40	SP6T40	SP6T40	SP6T40	SP6T40	SP6T40	SP6T40	SP6T40	SP6T40	SP6T40	SP6T40
	2	MTS40	MTS40	MTS40	SPDT40	Blank	Blank	Blank	Blank	Blank	Blank	Blank	Blank



ZTM2-6SP8T-12



ZTM-204

# MECHANICAL SWITCH MATRICES

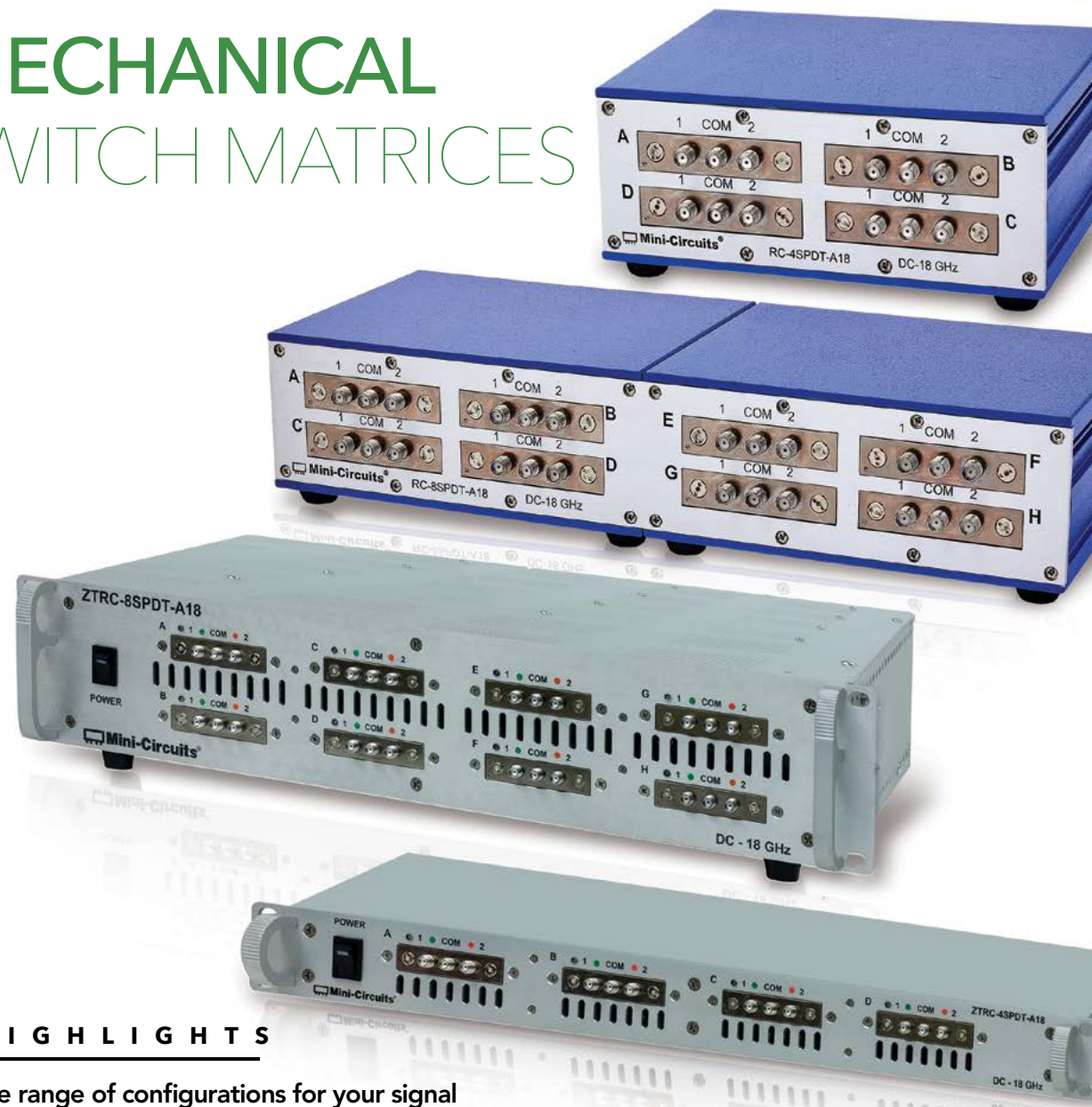

## HIGHLIGHTS

A wide range of configurations for your signal routing needs up to 40 GHz!

- Compact benchtop modules and rack-mount systems
- SPDT, SP4T, SP6T, SP8T, and transfer switch configurations
- USB and Ethernet control options
- User-friendly GUI and API included
- High isolation

# MECHANICAL SWITCH MATRICES



## ZTRC SERIES

Model	Switch Type	Number of Switches	F. Low (GHz)	F. High (GHz)
ZTRC-4SPDT-A26	SPDT	4	DC	26.5
ZTRC-8SPDT-A26	SPDT	8	DC	26.5
ZTRC-4SPDT-A18	SPDT	4	DC	18
ZTRC-8SPDT-A18	SPDT	8	DC	18



## RC-SERIES

Model	Switch Type	Number of Switches	F. Low (GHz)	F. High (GHz)
RC-2SP4T-40	SP4T	2	DC	40
RC-2SP4T-26	SP4T	2	DC	26.5
RC-2SP6T-26	SP6T	2	DC	26.5
RC-2MTS-18	Transfer	2	DC	18
RC-8SPDT-A18	SPDT	8	DC	18
RC-4SPDT-A18	SPDT	4	DC	18
RC-3SPDT-A18	SPDT	3	DC	18
RC-2SPDT-A18	SPDT	2	DC	18
RC-1SPDT-A18	SPDT	1	DC	18
RC-2SP4T-A18	SP4T	2	DC	18
RC-1SP4T-A18	SP4T	1	DC	18
RC-2SP6T-A12	SP6T	2	DC	12
RC-1SP6T-A12	SP6T	1	DC	12



# SOLID STATE SWITCHES



## HIGHLIGHTS

Fast switching and high isolation to improve efficiency in your setup

- Compact switch modules and custom rack mount switch matrices
- Many combinations of SPDT, SP4T, SP8T, SP10T, and SP16T switch configurations
- Wide bandwidth
- Unique designs achieve high isolation
- User-friendly GUI and API included

# SOLID STATE SWITCHES



## ZTS SERIES

Model	Control Interface	Switch Type	Number of Switches	F. Low (MHz)	F. High (MHz)
ZTS-6SP8T-63R	USB & Ethernet	SP8T	6	10	6000
ZTS-8SP8T-63	USB & Ethernet	SP8T	8	10	6000



## SOLID STATE SWITCHES

Model	Control Interface	Switch Type	Number of Switches	F. Low (MHz)	F. High (MHz)
U2C-1SP2T-63VH	USB / I <sup>2</sup> C / SPI	SP2T	1	10	6000
USB-2SP2T-DCH	USB	SP2T	2	DC	8000
USB-4SP2T-63H	USB	SP2T	4	10	6000
U2C-1SP4T-63H	USB / I <sup>2</sup> C	SP4T	1	2	6000
USB-2SP4T-63H	USB	SP4T	2	10	6000
USB-1SP8T-63H	USB	SP8T	1	10	6000
SPI-SP10T-63	SPI	SP10T	1	1	6000
USB-1SP16T-83H	USB / TTL	SP16T	1	1	8000

# PROGRAMMABLE ATTENUATORS



## HIGHLIGHTS

Precise level control perfect for transmission loss simulation, signal fading / handover system evaluation, telecoms network infrastructure, and more!

- Supporting applications up to 40 GHz
- USB, Ethernet, RS232, and SPI control options
- User-friendly GUI and API included

## RUDAT, RCDAT & RC4DAT- SERIES

Model	Control Interface	# of Channels	F. Low (MHz)	F. High (MHz)	Attn. Range (dB)	Max Input Power (dBm)
RCDAT-40G-30	USB & Ethernet	1	100	40000	0 – 30	24
RCDAT-30G-30	USB & Ethernet	1	100	30000	0 – 30	24
RCDAT-8000-30	USB & Ethernet	1	1	8000	0 – 30	28
RCDAT-8000-60	USB & Ethernet	1	1	8000	0 – 60	28
RCDAT-8000-90	USB & Ethernet	1	1	8000	0 – 90	28
RCDAT-6000-30	USB & Ethernet	1	1	6000	0 – 30	20
RCDAT-6000-60	USB & Ethernet	1	1	6000	0 – 60	20
RCDAT-6000-90	USB & Ethernet	1	1	6000	0 – 90	20
RCDAT-6000-110	USB & Ethernet	1	1	6000	0 – 110	20
RCDAT-4000-120	USB & Ethernet	1	1	4000	0 – 120	20
RCDAT-3000-63W2	USB & Ethernet	1	50	3000	0 – 63	33
RC4DAT-6G-30	USB & Ethernet	4	1	6000	0 – 30	23
RC4DAT-6G-60	USB & Ethernet	4	1	6000	0 – 63	23
RC4DAT-6G-95	USB & Ethernet	4	1	6000	0 – 95	20
RUDAT-13G-60	USB, SPI, & RS232	1	10	13000	0 – 60	23
RUDAT-13G-90	USB, SPI, & RS232	1	10	13000	0 – 90	23
RUDAT-6000-30	USB & RS232	1	1	6000	0 – 30	20
RUDAT-6000-60	USB & RS232	1	1	6000	0 – 60	20
RUDAT-6000-90	USB & RS232	1	1	6000	0 – 90	20
RUDAT-6000-110	USB & RS232	1	1	6000	0 – 110	20
RUDAT-4000-120	USB & RS232	1	1	4000	0 – 120	20



# PROGRAMMABLE ATTENUATORS

## ZTDAT-SERIES



### ZTDAT-8-6G95 (8-Channels)

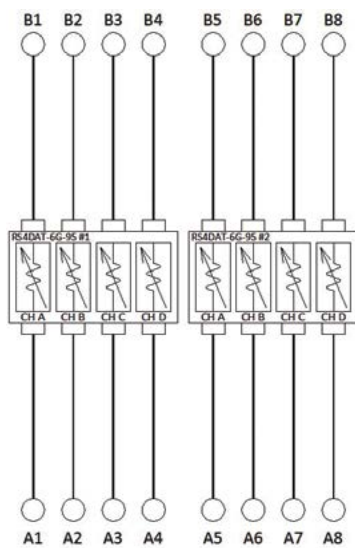

### ZTDAT-12-6G95 (12-Channels)

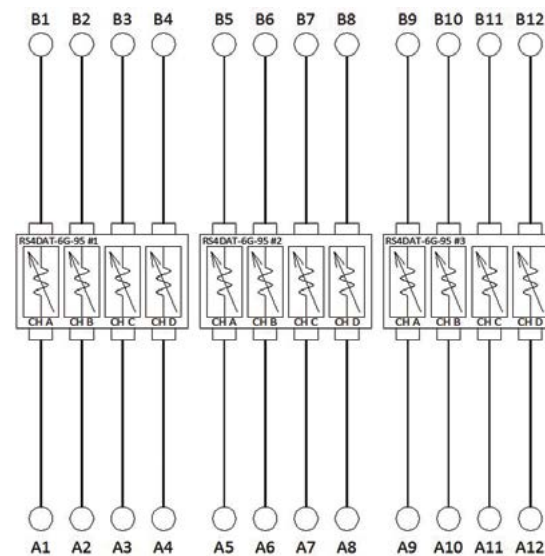

### ZTDAT-16-6G95 (16-Channels)

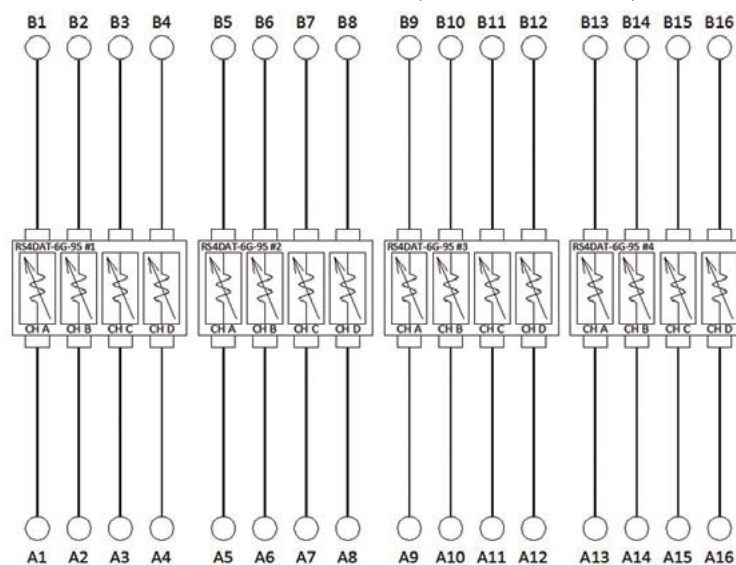

### ZTDAT-24-6G95 (24-Channels)

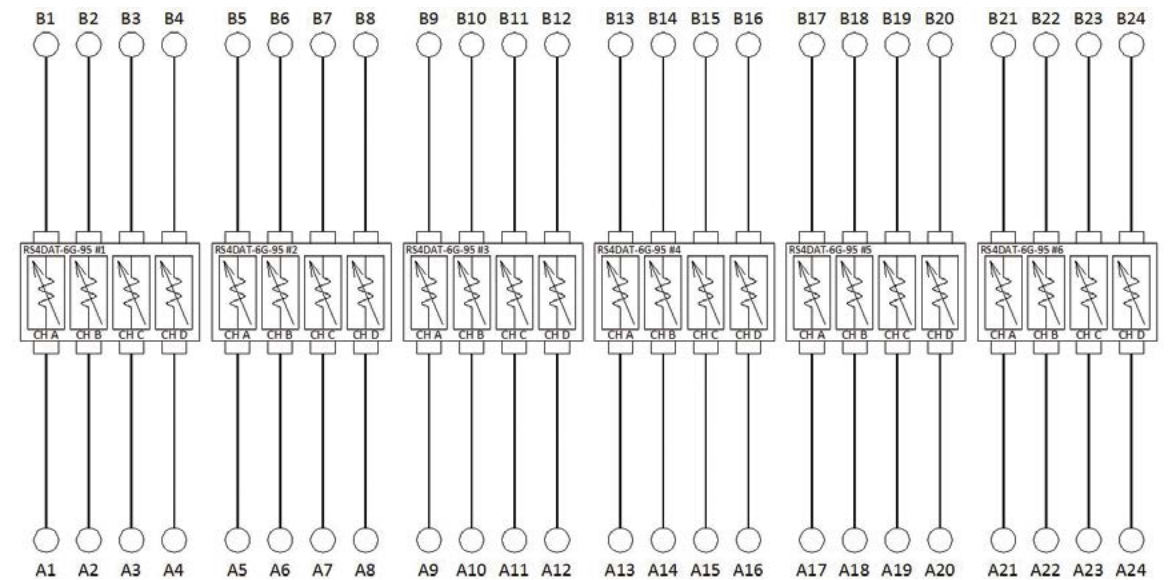

## TYPICAL PERFORMANCE

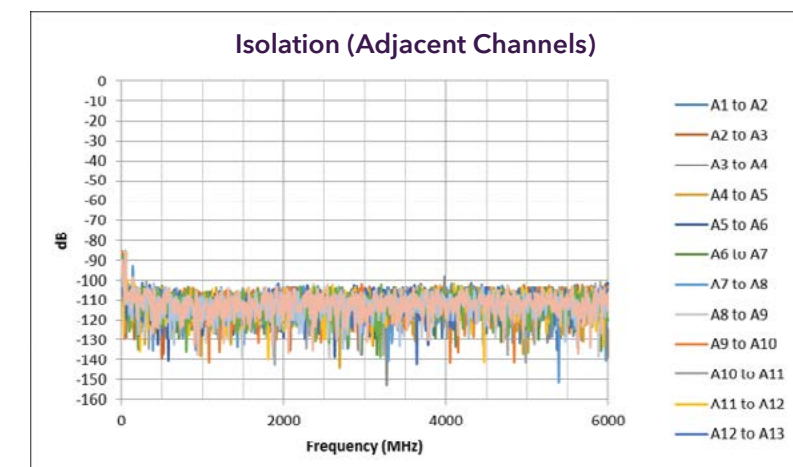
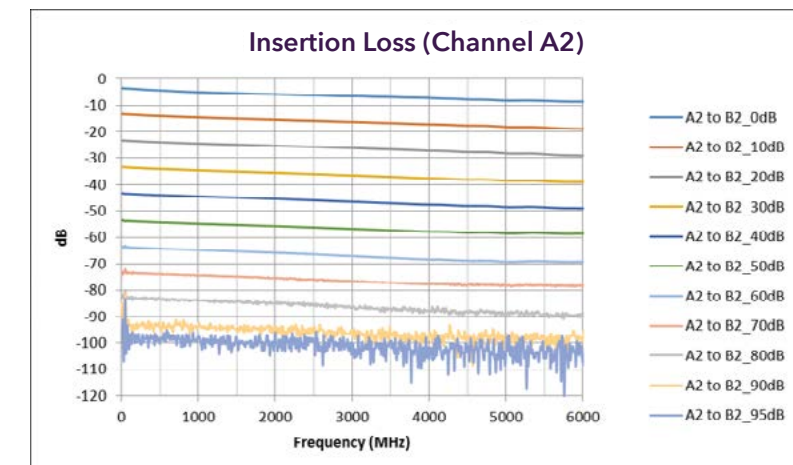

PROGRAMMABLE ATTENUATORS

PROGRAMMABLE ATTENUATORS

# MESH NETWORK TEST SYSTEMS

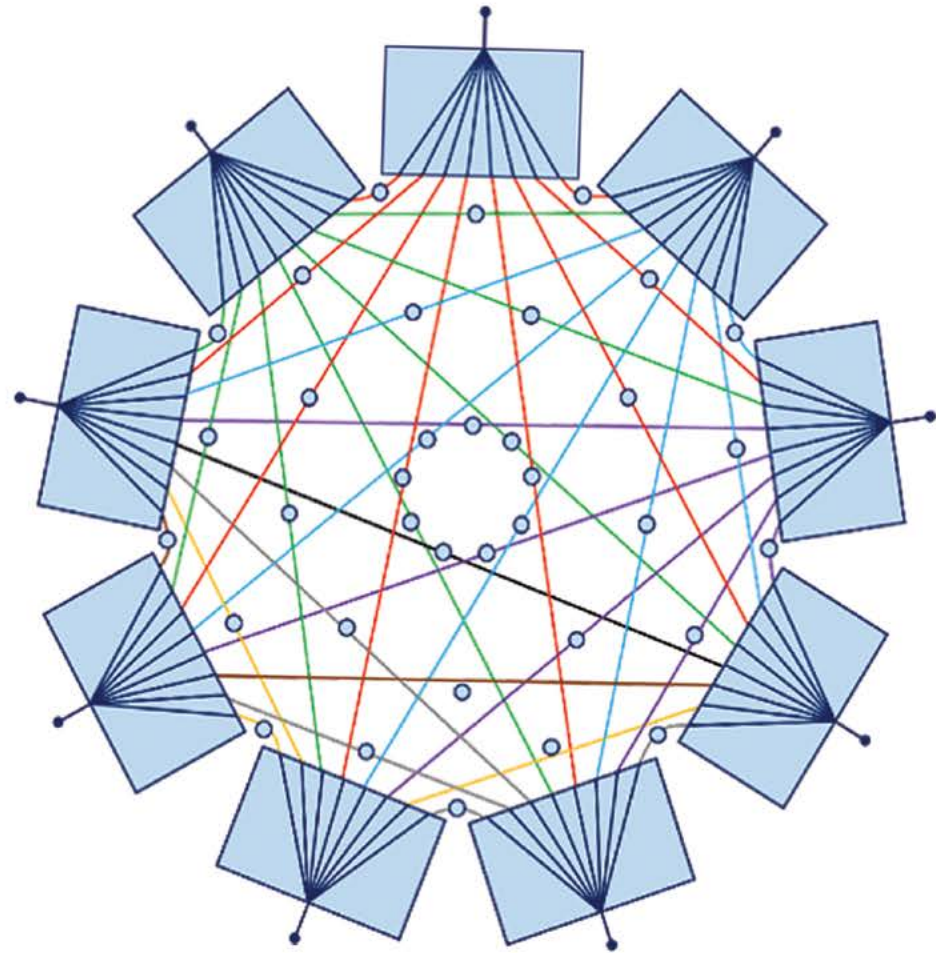

## H I G H L I G H T S

### Multi-port networks for interconnecting 3 to n devices or test systems

- Allows simulation of “real-world” mesh communication network in production environment
- Independently controlled attenuation on every path
- Ideal for testing Bluetooth and Zigbee devices, wireless handsets, and Wi-Fi systems

## MESH NETWORK TEST SYSTEMS

### Multi-Port Networks for Interconnecting 3 to n Devices

Mesh networks allow simultaneous interconnection of 3 to n devices or test systems. Common applications include testing of Bluetooth and Zigbee devices, wireless handsets and Wi-Fi systems.

Mini-Circuits has developed a range of mesh networks with independently variable attenuation on every path. This concept allows simulation of a “real-world” mesh communication network in the confined space of a production environment. Path loss can be varied independently between any pair of devices, simulating the effects of distance and interference, without affecting any other paths.

Number of ports, operating frequency and path attenuation range (up to 120 dB) can be tailored to the specific test requirement.

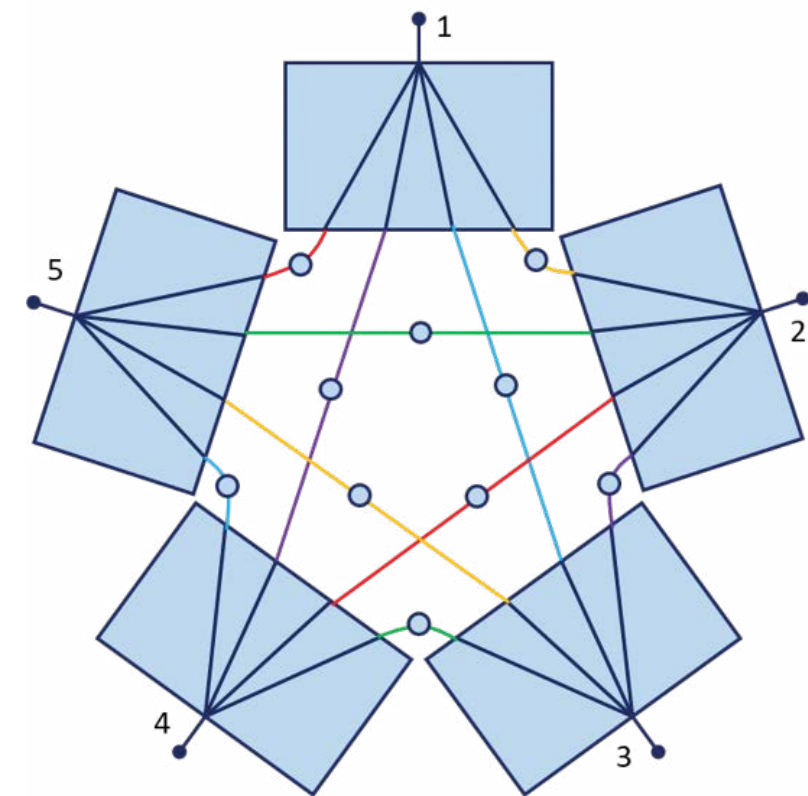

○ = programmable attenuator



# MESH NETWORK TEST SYSTEMS

- Attenuation Range: 0 - 95dB
- Connector Options: SMA, N-Type, TNC

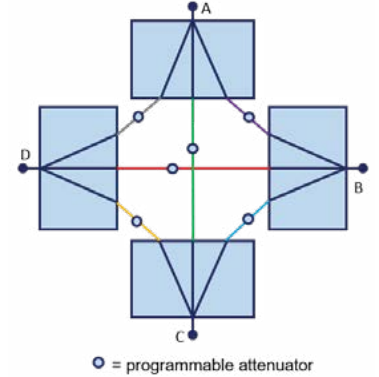
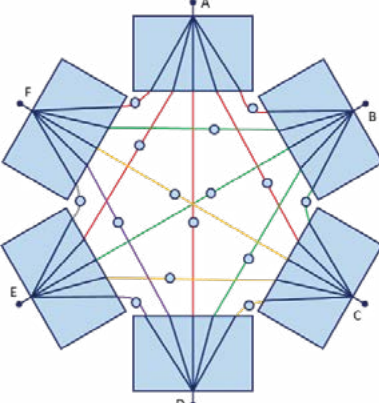
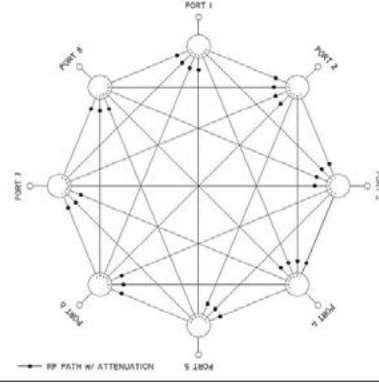
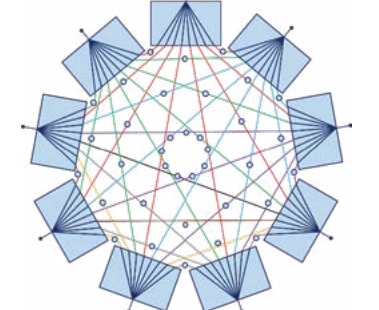
Model	Frequency (MHz)	Number of Ports	Photo
ZTMN-0495AS	350 - 6000	4	
ZTMN-0695A-T	2000 - 6000	6	
ZTMN-0695B-S	600 - 6000	6	
ZTMN-0890A-S	30 - 2000	8	
ZTMN-0895B-S	500 - 6000	8	
ZTMN-0995A-S	500 - 6000	9	

## PERFORMANCE OF ZTMN-0495AS

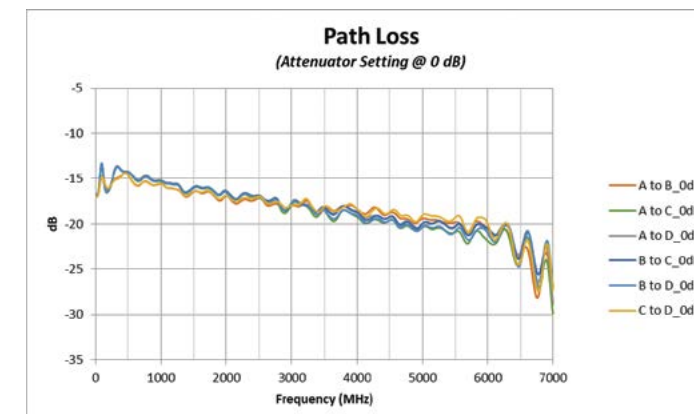
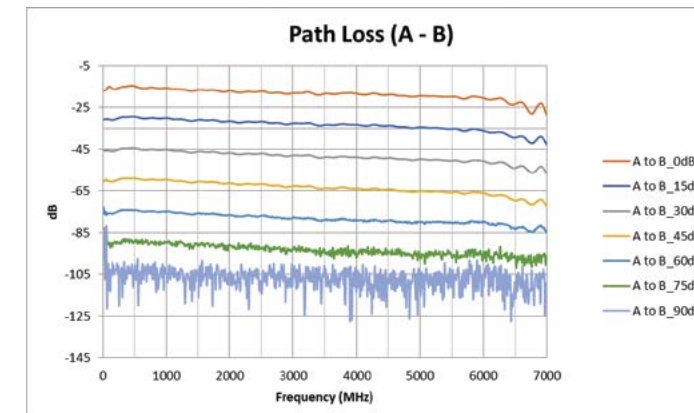

## CUSTOM MESH NETWORK DESIGN

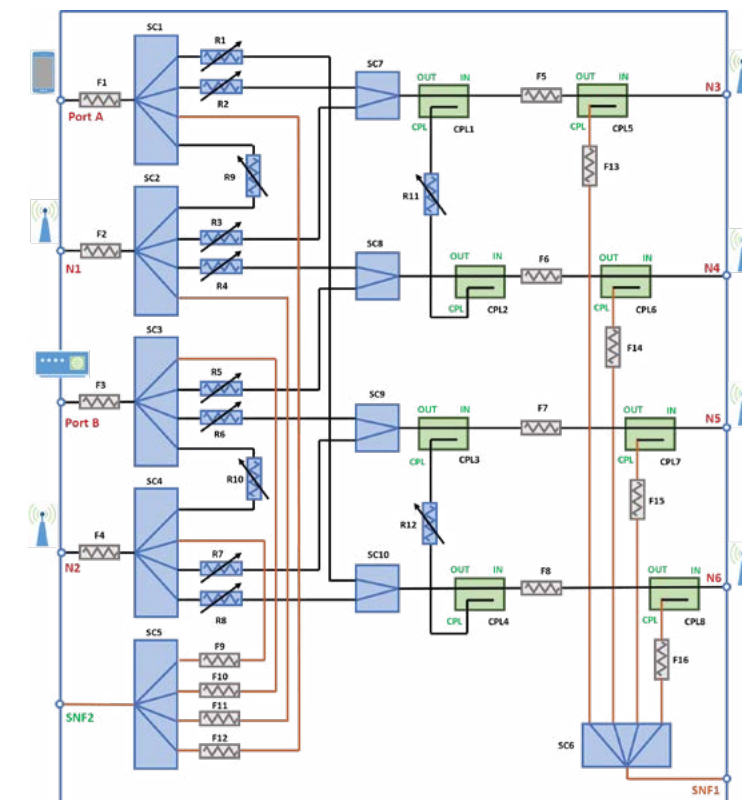

# INSTRUMENTATION AMPLIFIERS



## HIGHLIGHTS

- Large Selection of Modules
- Custom Integration
- Quick Turn Around
- Rugged Construction

## INSTRUMENTATION AMPLIFIERS

### ZT-270

Mini-Circuits' ZT-270 is an UHF band variable gain amplifier (VGA) with 4 independently controlled channels. Each channel provides up to 2W output power with 30 dB gain control at 0.25 dB steps. Four separate ON/OFF power switches on the front panel allow any channel to be quickly and safely isolated by terminating the input signal into an internal load.

The gain can be controlled via USB or Ethernet (supporting both HTTP and Telnet network protocols). Full software support is provided, including our user-friendly GUI application for Windows operating systems.

The system is housed in a compact 19-inch rack chassis (3U height) with SMA connectors, 4 x RF inputs on the front panel and 4 x RF outputs on the rear panel.

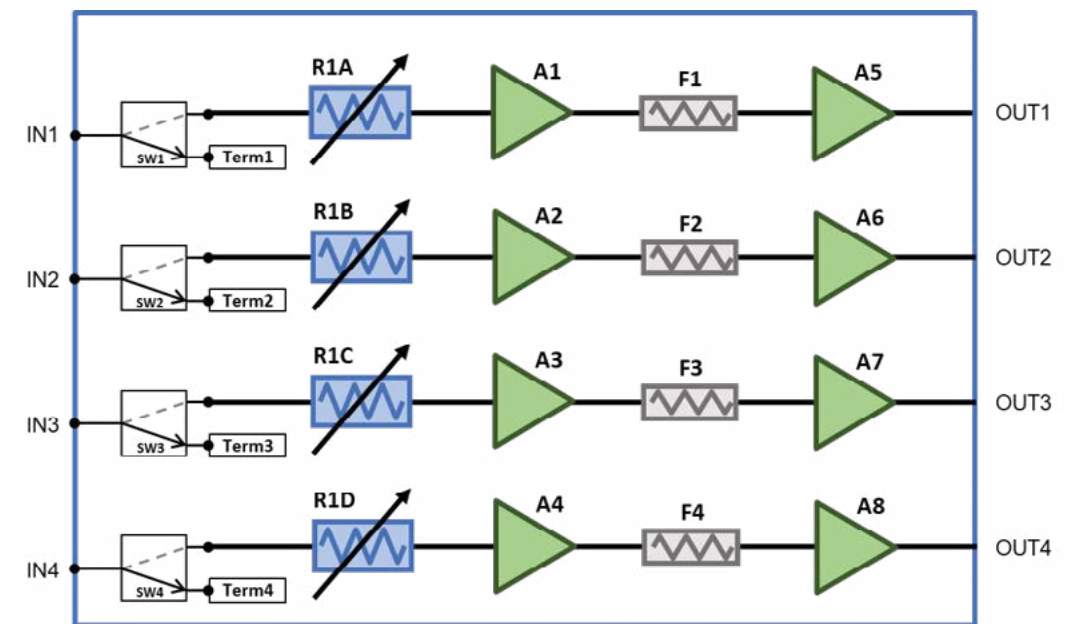

### ZT-285

ZT-285 is a 12-channel amplifier system, supplied in a 2U height, 19" rack-mount chassis with a single AC mains power supply connection and SMA input / output connectors on the front and rear panels. Each independent amplifier channel operates over 500-2500 MHz, ideal for L-band satellite communications and telecommunications applications, achieving high gain and high directivity across the band.

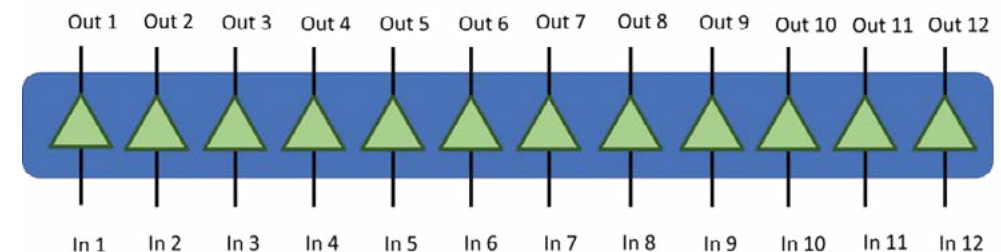



# NxM SWITCH MATRICES



## HIGHLIGHTS

Reliable and repeatable signal routing with USB and Ethernet control. Ideal for multi-channel / MIMO test systems, cellular base-station / handset testing, satcoms signal routing, and more.

- 19 inch rack mount chassis
- USB and Ethernet standard control interfaces
- Custom switch configurations built to order
- User-friendly GUI and API included

# NxM SWITCH MATRICES

## BLOCKING SWITCH MATRICES

- Multiple switch paths with "one to one" configuration (each input connects to a single output)
- High reliability switches on inputs and outputs
- Bi-directional operation
- Low loss and high isolation

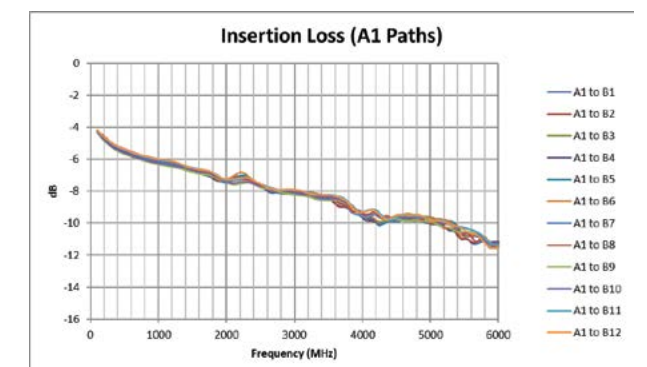
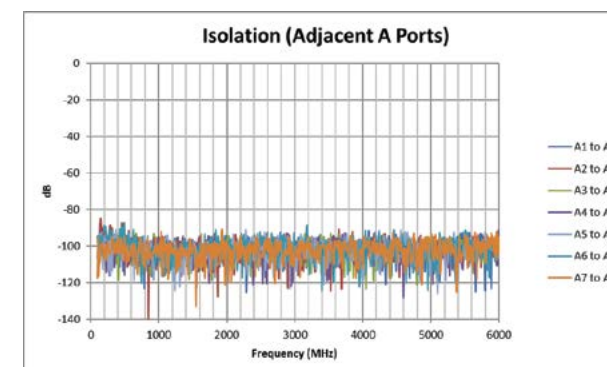
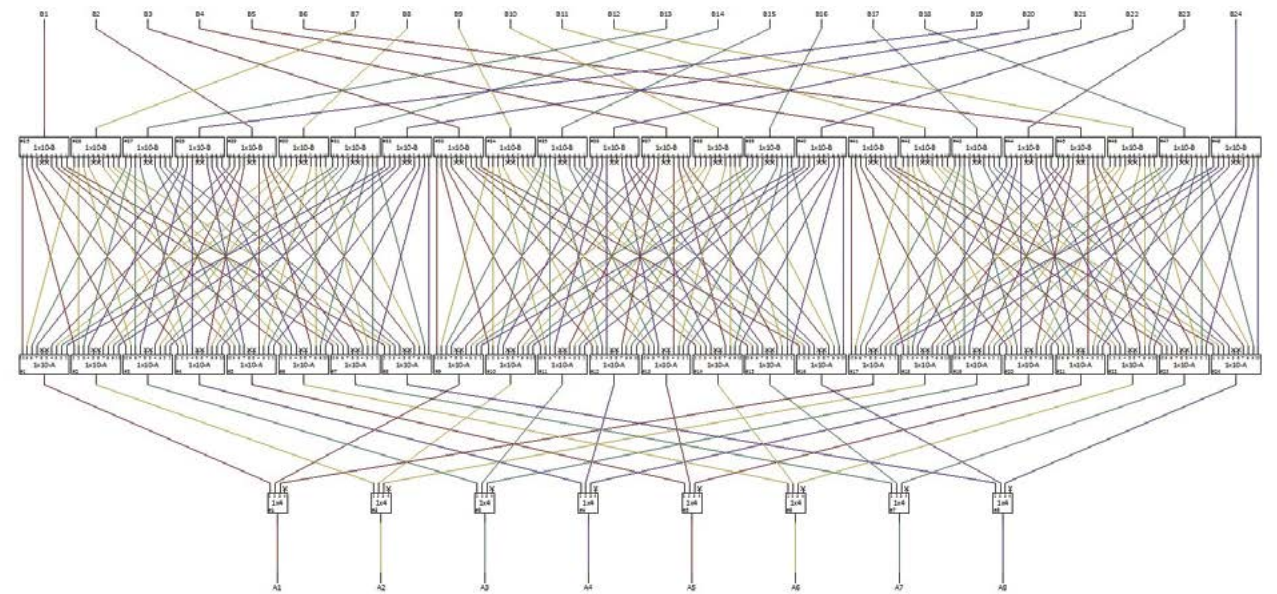



# NxM SWITCH MATRICES

## NON-BLOCKING SWITCH MATRICES

- Bi-directional operation

## FAN OUT CONFIGURATION

- Multiple switch paths with "one to many" configuration (each input can connect to multiple outputs)
- Splitters on input and switches on output

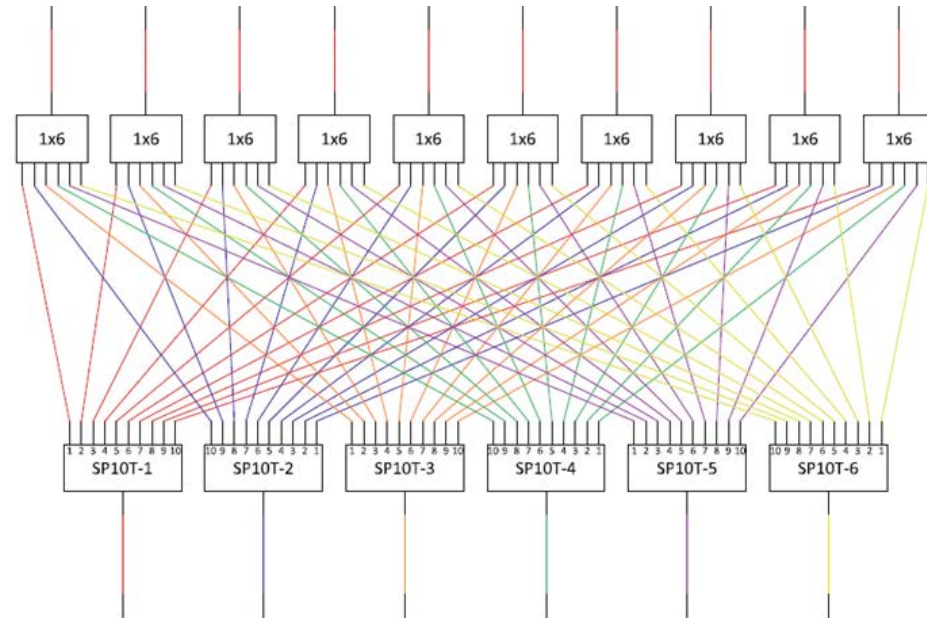

## FAN IN CONFIGURATION

- Multiple switch paths with "many to one" configuration (multiple inputs can connect to each outputs)
- Switches on input and splitters on output

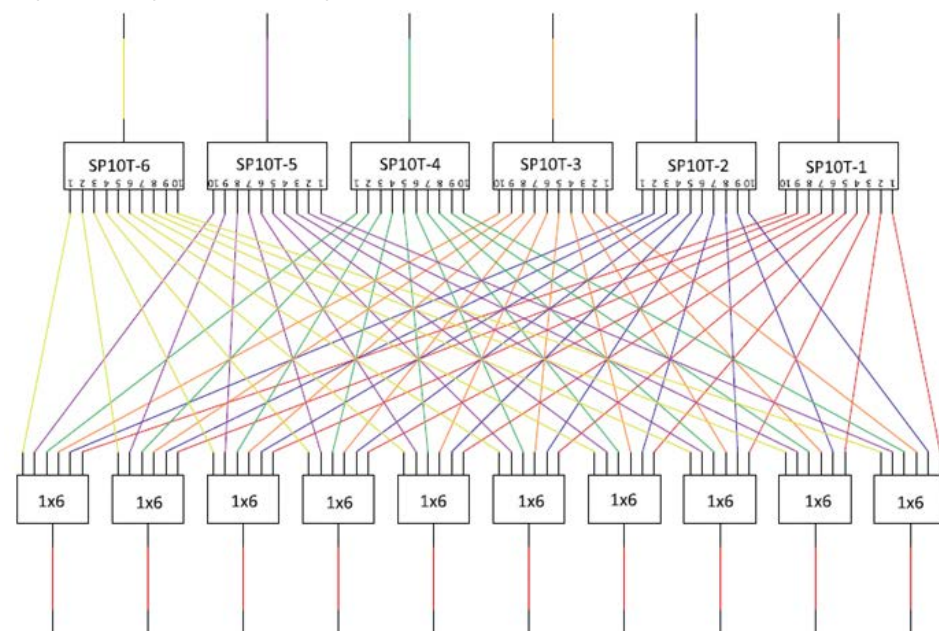

## ZT-10X6NB



Insertion Loss (B1 Paths)

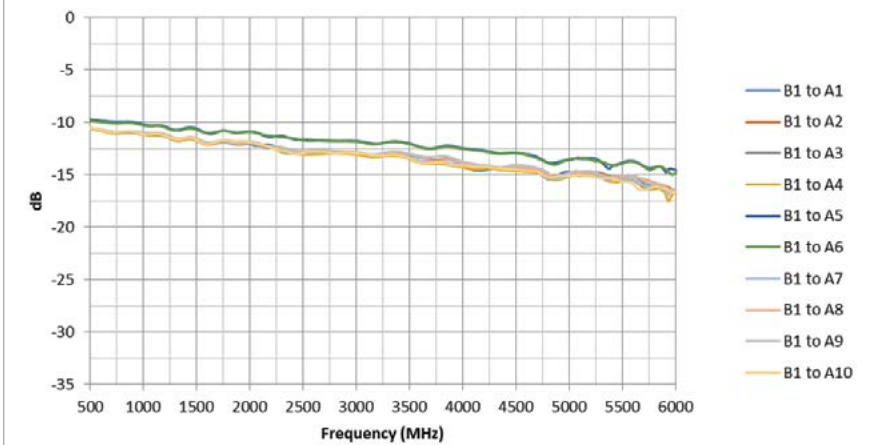

Isolation

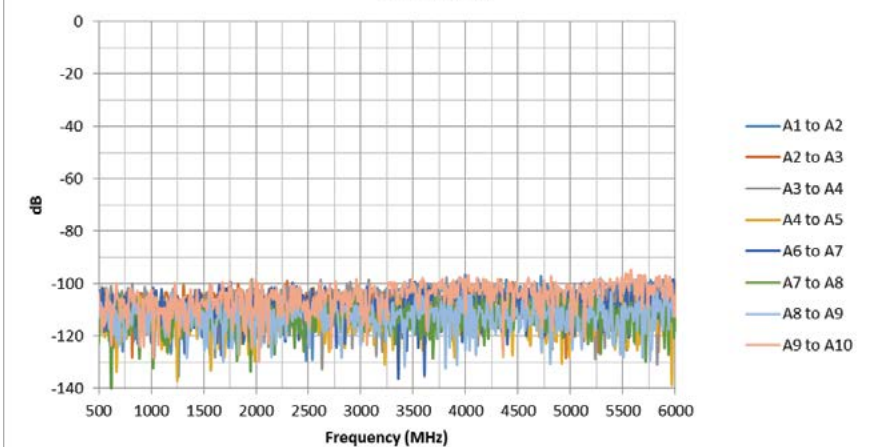



# NxM SWITCH MATRICES



## ZTVX- 50Ω & 75Ω SERIES

Mini-Circuits' ZTVX- series comprises a range of flexible, 2 by n switch matrices, available in 19-inch rack-mountable chassis with all RF connections accessible on the front panel. The 50Ω Series covers DC to 12 or 18 GHz with a 2U height while the 75Ω Series covers 5 to 2500 MHz with a 3U or 4U height. This system is available in a range of blocking switch matrix configurations from 2 x 8 to 2 x 16, ideal as a VNA extender in a wide range of applications, or expanding a standard 2 port VNA for a multi-port or multi-device test scenario:

- Parallel testing of multiple 2 port devices (eg: filter and amplifier production testing)
- Production testing of splitter/combiner or switch components with high port counts
- Testing of MIMO systems with high channel counts

## SOFTWARE

The system can be controlled via USB or Ethernet (supporting both HTTP and Telnet network protocols). Full software support is provided, including our user-friendly GUI application for Windows and a full API with programming instructions for Windows and Linux environments (both 32-bit and 64-bit systems).

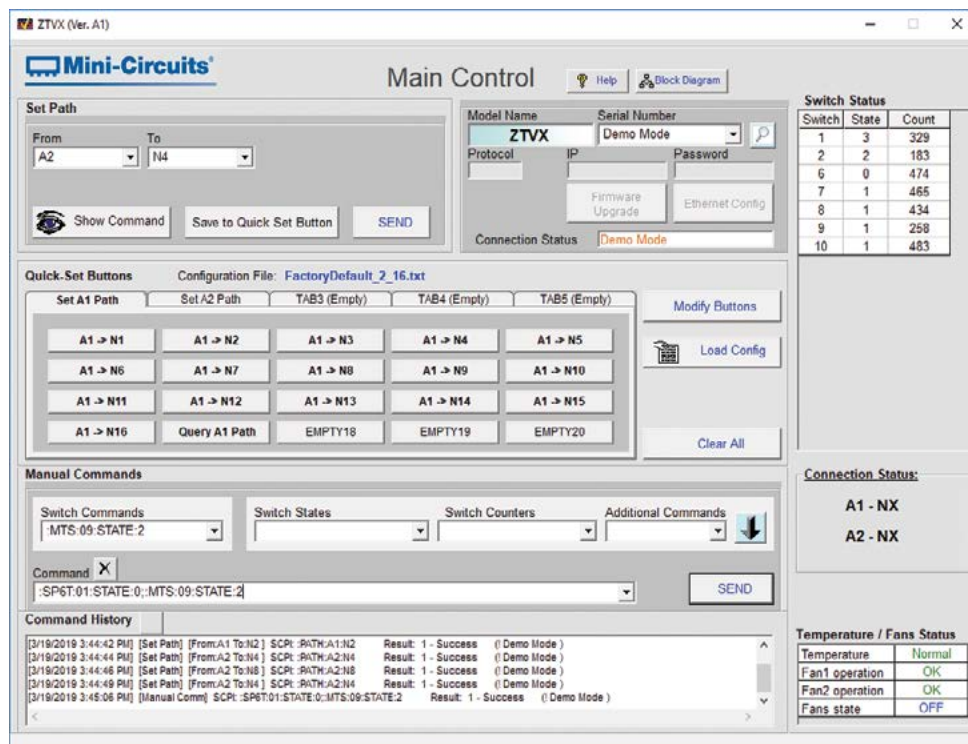

# NxM SWITCH MATRICES

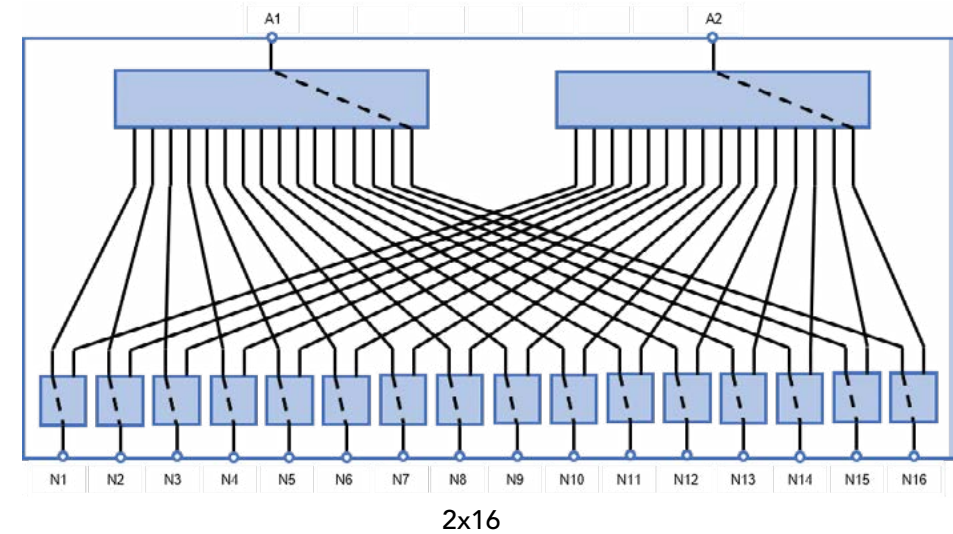

## 50Ω SERIES

Model Name	Frequency (GHz)	Number of Inputs	Number of Outputs
ZTVX-8-18-S	DC – 18	2	8
ZTVX-10-18-S	DC – 18	2	10
ZTVX-12-18-S	DC – 18	2	12
ZTVX-16-18-S	DC – 18	2	16
ZTVX-8-12-S	DC – 12	2	8
ZTVX-10-12-S	DC – 12	2	10
ZTVX-12-12-S	DC – 12	2	12
ZTVX-16-12-S	DC – 12	2	16



## 75Ω SERIES

Model Name	Frequency (MHz)	Number of Inputs	Number of Outputs
ZTVX-8-75-N	5 – 2500	2	8
ZTVX-10-75-N	5 – 2500	2	10
ZTVX-12-75-N	5 – 2500	2	12
ZTVX-16-75-N	5 – 2500	2	16

# SIGNAL GENERATION MEASUREMENT & CONTROL



## HIGHLIGHTS

Benchtop devices for RF test and measurement applications

- Synthesized signal generators
- Power sensors and frequency counters
- Control products
- User-friendly GUI and API included



# SIGNAL GENERATION MEASUREMENT & CONTROL



## POWER SENSORS

Model	Control Interfaces	Sensor Type	Impedance ( $\Omega$ )	F. Low (MHz)	F. High (MHz)
PWR-8GHS-RC	USB & Ethernet	CW	50	1	8000
PWR-8GHS	USB	CW	50	1	8000
PWR-8FS	USB	CW	50	1	8000
PWR-8P-RC	USB & Ethernet	Peak & Avg.	50	10	8000
PWR-6RMS-RC	USB & Ethernet	RMS	50	50	6000
PWR-6LRMS-RC	USB & Ethernet	RMS	50	50	6000
PWR-6LGHS	USB	CW	50	50	6000
PWR-6GHS	USB	CW	50	1	6000
PWR-4GHS	USB	CW	50	0.009	4000
PWR-2.5GHS-75	USB	CW	75	0.1	2500



## SIGNAL GENERATORS

Model	Control Interfaces	F. Low (MHz)	F. High (MHz)	Power (dBm) Min.	Power (dBm) Max.
SSG-6000RC	USB & Ethernet	25	6000	-65	+14
SSG-6001RC	USB & Ethernet	1	6000	-70	+15

## FREQUENCY COUNTER/ POWER METER

Model	Control Interfaces	Sensor Type	F. Low (MHz)	F. High (MHz)
FCPM-6000RC	USB & Ethernet	CW	1	6000



## INPUT / OUTPUT CONTROL BOXES

Model	Control Interfaces	LVTTTL / TTL Digital Inputs	LVTTTL / TTL Digital Outputs	Relays
USB-I/O-16D8R	USB	16 / 8 / 0	0 / 8 / 16	8
USB-I/O-8DRV	USB	8 / 0	0 / 8	8





# HIGH POWER TEST SYSTEMS

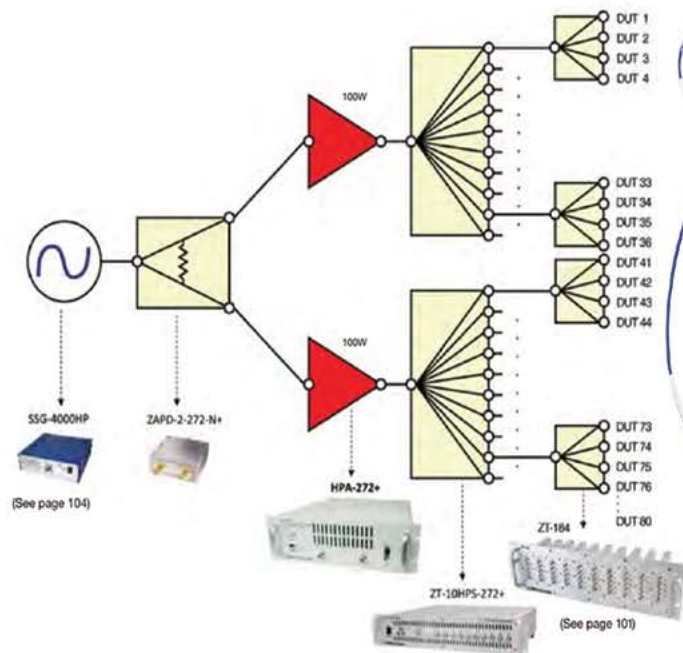

## HIGHLIGHTS

Mini-Circuits HPA-Series amplifiers can be used to drive 80 test channels in a configuration similar to that shown here. This setup is popular for use in high-throughput production testing applications where parallel processing of many DUTs is a requirement.



# HIGH POWER TEST SYSTEMS



## HPA SERIES

Model	F. Low (MHz)	F. High (MHz)	Gain (dB) Typ.	Output Power @ 1dB Comp. (dBm), Typ.	Saturated Output Power (dBm), Typ.
HPA-272+	700	2700	48	49	50
HPA-25W-272+	20	2700	50	38	44
HPA-50W-63+	700	6000	56	43	47
HPA-100W-63+	2500	6000	58	43	50



## HIGH POWER SPLITTERS

Model	F. Low (MHz)	F. High (MHz)	Description
ZT-10HPS-272	700	2700	100W 10-Way Rack Mounted Splitter
ZT-20HPS-63-S	2500	6000	100W 20-Way Rack Mounted Splitter
ZT-184	250	6000	10x 4-Way High Power Splitter Panel

# PANEL MOUNTED STRUCTURES



## HIGHLIGHTS

Simplify connections and cable management in complex test racks

- 19 inch rack mount panel
- Custom configurations of adapters and splitters

## PANEL MOUNTED STRUCTURES

Model	Frequency (MHz)	Description	Photo
ZT-184	500 – 6000	10x 4-Way Splitter Panel, ZN4PD1-63LW-S+	
ZT-222	350 – 6000	20x 2-Way Splitter Panel, ZN2PD2-63-N+	
ZT-229B	0.5 – 600	16x 2-Way Splitter Panel, Z99SC-62-S+	
ZT-245	300 – 1000	1x 8-Way Splitter Panel, ZC8PD1-10-S+	



# PANEL MOUNTED STRUCTURES

Model	Frequency (MHz)	Description	Photo
ZT-255	500 – 8500	8x 2-Way Splitter Panel, ZX10-2-852-S+	
ZT-256	DC – 18000	12x 2-Way Splitter Panel, ZFRSC-183-S+	
ZT-230	1 – 500	8x 10dB Coupler Panel, ZFDC-10-1-S+	
ZT-275	DC – 18000	10x 30dB Attenuator Panel, BW-S30W20+	

# PANEL MOUNTED STRUCTURES

Model	Frequency (MHz)	Description	Photo
ZT-183	DC – 6000	48x N-F to SMA-F Adapter Panel	
ZT-240	DC – 6000	36x N-F to N-F Adapter Panel w/ Special Mounting Bracket	
ZT-240BK	DC – 6000	36x N-F to N-F Adapter Panel w/ Black Anodized Panel	
ZT-96KFFL-KF50+	DC – 40000	96x 2.92-F to 2.92-F Adapter Panel	

# SIGNAL DISTRIBUTION



## HIGHLIGHTS

Splitter / combiner and direction coupler arrays for distribution of test signals through multiple channels

- Rack-mounted, panel-mounted, or benchtop structures
- Wide range of splitter configurations
- Wideband splitters up to 65 GHz

## SIGNAL DISTRIBUTION

Model	Frequency (MHz)	Description	Photo
ZT-104	10	16-Way Active Splitter, BNC	
ZT-152	700 – 2500	GPS Amplifier w/ 4 Output Channels	
ZT-161RS	1200 – 1600	GPS Amplifier w/ 16 Output Channels	



# SIGNAL DISTRIBUTION

Model	Frequency (MHz)	Description	Photo
ZT-201	350 – 6000	20x 2-Way Splitter Box, N-Type	
ZT-207	350 – 6000	6x 2-Way Splitter Box, N-Type to SMA	
ZT-208	380 – 4600	4x 4-Way Splitter Box, N-Type	

# SIGNAL DISTRIBUTION

Model	Frequency (MHz)	Description	Photo
ZT-241	5 – 500	4x 75Ω 4-Way Splitter Box, BNC	
ZT-246	350 – 6000	16x 2-Way Splitter Box, SMA	
ZT-262	500 – 6000	4x 2-Way Splitter Box, N-Type	

# CUSTOM SYSTEMS

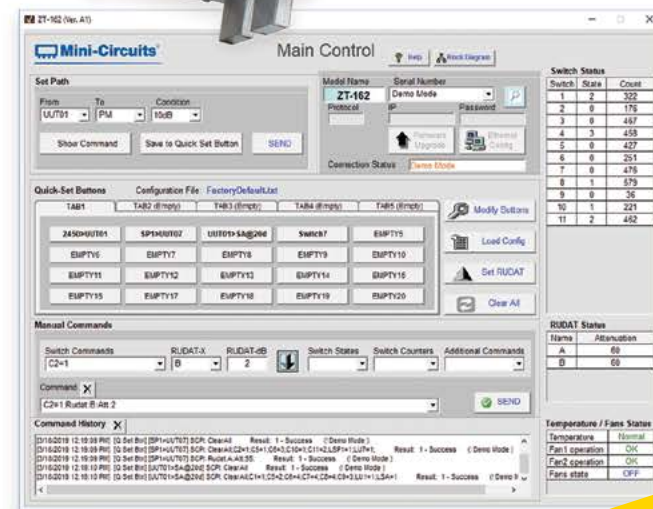
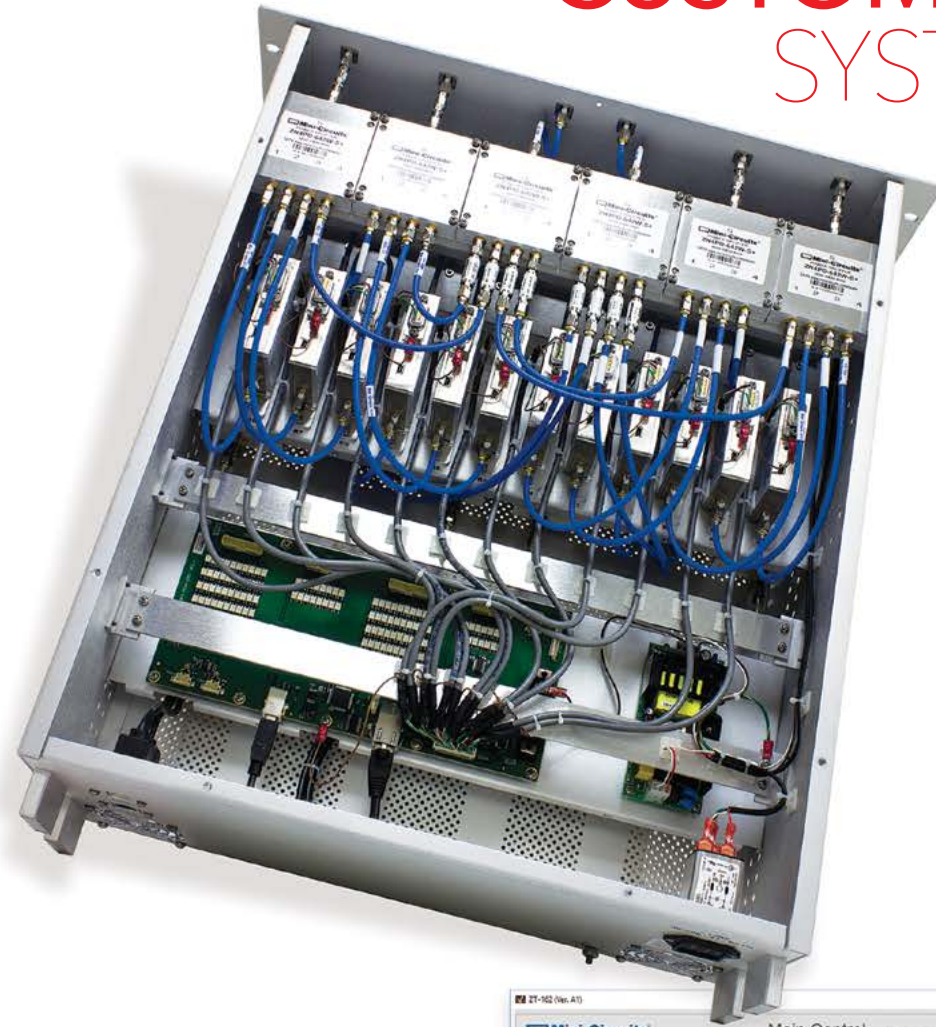

## HIGHLIGHTS

- Typical 8-weeks turnaround
- 100% RF Tested with Labview based automated test program
- Custom GUI with path control functions
- Rugged construction

## RACK-MOUNTED 4 x WI-FI DIPLEXING AMPLIFIER

50Ω 2400-2500 & 5700-5900 MHz



## PRODUCT OVERVIEW

ZT-228 is a 4-channel filtered amplifier for Wi-Fi. test applications. Each of the 4 inputs is split and independently amplified on separate paths for the low and high Wi-Fi bands (centered at 2.4-2.5 and 5.7-5.9 GHz respectively), with 60 dB typical rejection of the opposite band. The system is housed in a compact rack-mountable package of 1U height, with built in AC power supply.



## RF SPECIFICATIONS (PER CHANNEL)

Parameters	
Low Band	
Frequency	2.4-2.5 GHz
Gain	17 dB typ
P1dB	16 dBm typ
NF	6 dB typ
High Band Rejection	60 dB typ
High Band	
Frequency	5.7-5.9 GHz
Gain	17 dB typ
P1dB	17 dBm typ
NF	4 dB typ
Low Band Rejection	60 dB typ
Input Power	10 dBm max
Pass Band Return Loss	12 dB typ

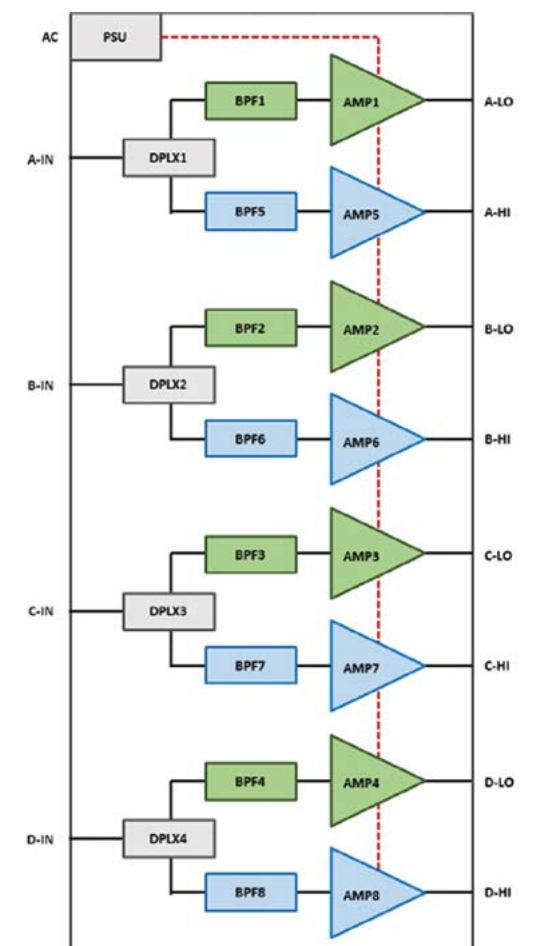



RACK-MOUNTED  
**WIRELESS BASE-STATION** HANDSET TEST STATION

50Ω 1600-2300 MHz



**PRODUCT OVERVIEW**

ZT-188 was developed as a multi-function test set for low capacity trunk radio and other wireless BTS /handset test environments. The core of the system is a 4x8 non-blocking switch matrix, allowing up to 8 handsets /terminals to be simultaneously routed to any combination of 4BTS, with input powers of up to 20 W per port in either direction. The system also provides auxiliary test ports which allow an external test signal to be injected to any BTS or the output to be monitored with an external spectrum analyser.



RACK-MOUNTED  
**SWITCH FILTER** BANK

50Ω 1000-3000 MHz



**PRODUCT OVERVIEW**

ZT-254 is a compact, rack-mounted, filter bank capable of housing up to 6 switched channels. Filter choices can be made from any of Mini-Circuits' 100s of catalog or custom models, and third-party supplied filters can also be accommodated.

The ZT-254 configuration includes channels with band pass characteristics centred at 2110-2170 MHz, 1930-1990 MHz, 1805- 1880 MHz as well as an unfiltered through- path and the option to switch into a reflective load. Reverse isolation is provided through in order to protect the input signal source.



**RF SPECIFICATIONS AT 25°C**

Pass Bands	Value
Path 1	2110 - 2170MHz
Path 2	1930 - 1990 MHz
Path 3	1805 - 1880MHz
Path 4	1000 - 3000 MHz
Input Power	1W max
Pass Band Loss	4 dB max
Stop Band Rejection	50 dB min
Reverse Isolation	10 dB min
Pass Band Return Loss	10 dB typ

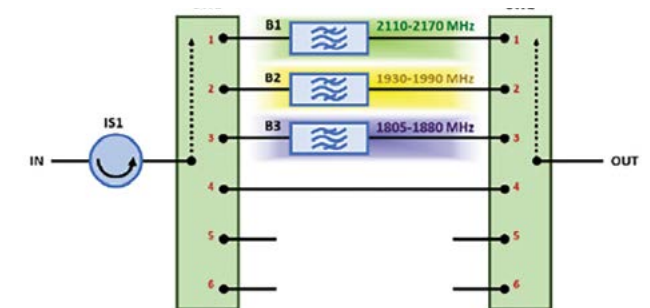

RACK-MOUNTED | USB & ETHERNET CONTROL  
**MECHANICAL SWITCH MATRIX**

50Ω DC-18 GHz



**PRODUCT OVERVIEW**

Mini-Circuits' ZT-276 is an integrated switching matrix designed for a custom calibration application at 9-11 GHz. The high reliability mechanical switches used are able to support a much wider range of applications from DC to 18 GHz and custom switch routings / configurations can be provided on request.

The system is housed in a 19-inch rack chassis with SMA RF connectors on the front and rear panels and a dual control system. The front panel includes push button controls with switch state indicators to allow the operator to set any switch path locally, and an override switch to enable or disable the remote communication interfaces.

The software control capability includes USB and Ethernet interfaces (supporting both HTTP and Telnet network protocols). Full software support is provided, including our user-friendly GUI application for Windows and a full API with programming instructions for Windows and Linux environments (both 32-bit and 64-bit systems).

RACK-MOUNTED | USB & ETHERNET CONTROL  
**MECHANICAL SWITCH MATRIX**

**GRAPHICAL USER INTERFACE (GUI) FOR WINDOWS - KEY FEATURES**

- Connect via USB or Ethernet
- Run GUI in "demo mode" to evaluate software without a hardware connection
- View and set all switch states and paths
- Set all front panel switch buttons
- Configure Ethernet settings
- Upgrade firmware
- Send SCPI commands
- View temperature & fan status

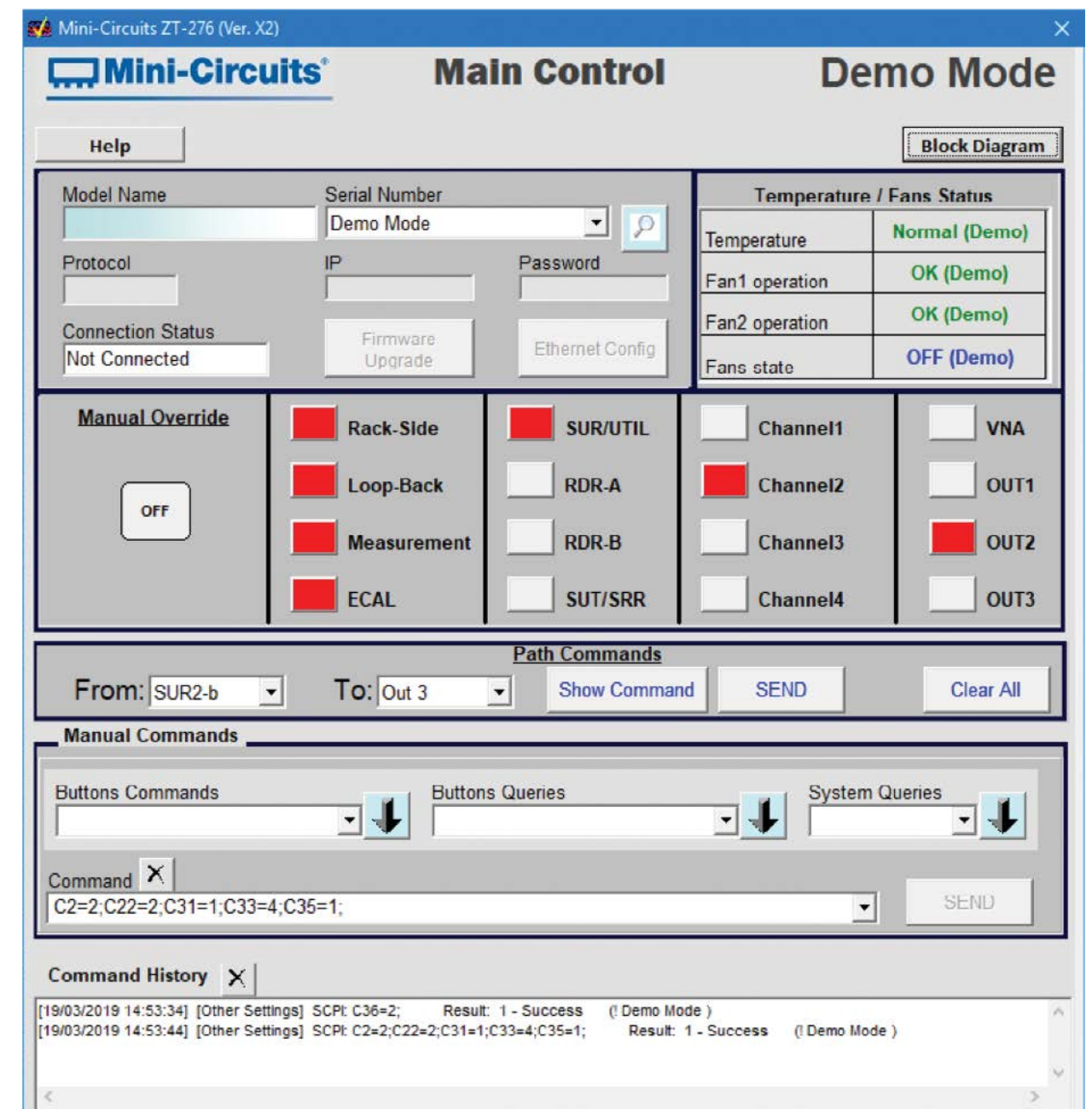

CUSTOM SYSTEMS

CUSTOM SYSTEMS





[www.minicircuits.com](http://www.minicircuits.com)

### *Direct Sales*

› **BROOKLYN**

[sales@minicircuits.com](mailto:sales@minicircuits.com)  
1 718-934-4500

› **MISSOURI**

[sales@minicircuits.com](mailto:sales@minicircuits.com)  
1 417-335-5935

› **EUROPE**

[sales@uk.minicircuits.com](mailto:sales@uk.minicircuits.com)  
44 1252-832600

› **TAIWAN**

[robert@min-kai.com.tw](mailto:robert@min-kai.com.tw)  
886 3 318 4450

### *Technical Support*

› **NORTH AMERICA**

[apps@minicircuits.com](mailto:apps@minicircuits.com)  
(718) 934-4500

› **SINGAPORE, INDONESIA  
MALAYSIA, THAILAND**

[sales@minicircuits.com.my](mailto:sales@minicircuits.com.my)  
(604) 646-2828

› **ISRAEL**

[app@ravon.co.il](mailto:app@ravon.co.il)  
972 4 8749100

› **TAIWAN & PHILIPPINES**

[robert@min-kai.com.tw](mailto:robert@min-kai.com.tw)

› **EUROPE**

[apps@uk.minicircuits.com](mailto:apps@uk.minicircuits.com)  
44 1252 832600

› **INDIA**

[apps@minicircuits.com](mailto:apps@minicircuits.com)  
91 44 2 2622575

› **CHINA**

[sales@mitron.cn](mailto:sales@mitron.cn)  
86 591-8787 0001  
Or  
[yuanzhong@minicircuits.com](mailto:yuanzhong@minicircuits.com)  
86 020-8734 0992