

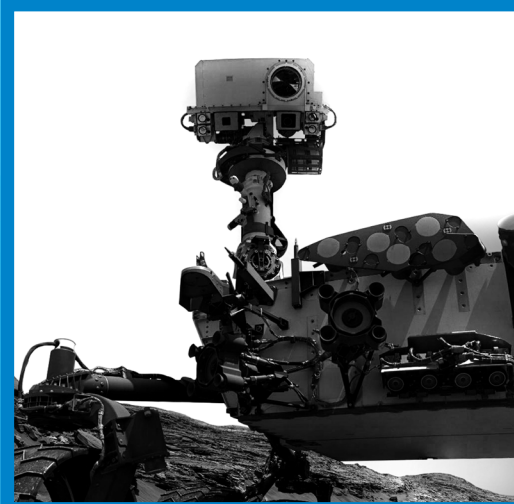

HIGH SPEED DIGITAL CONNECTOR TECHNOLOGY



OMNETICS
CONNECTOR CORPORATION



About Omnetics

Omnetics Connector Corporation is a privately held, world class connector design and manufacturing company with over 30 years experience focused on ultra-lightweight micro-miniature and nano-miniature highly reliable electronic connectors and interconnection systems. Our products are designed and assembled at our plant in Minneapolis, Minnesota that includes in-house automatic machining and overmolding equipment.

Omnetics' Flex Pin

Designed for High Shock and Vibration

Omnetics' Flex Pin contact was designed and produced many years before the creation of MIL-DTL-32139. This simple one piece design is stamped from ASTM B194 BeCu. The spring characteristic of BeCu is ideal for withstanding high shock and vibration situations.

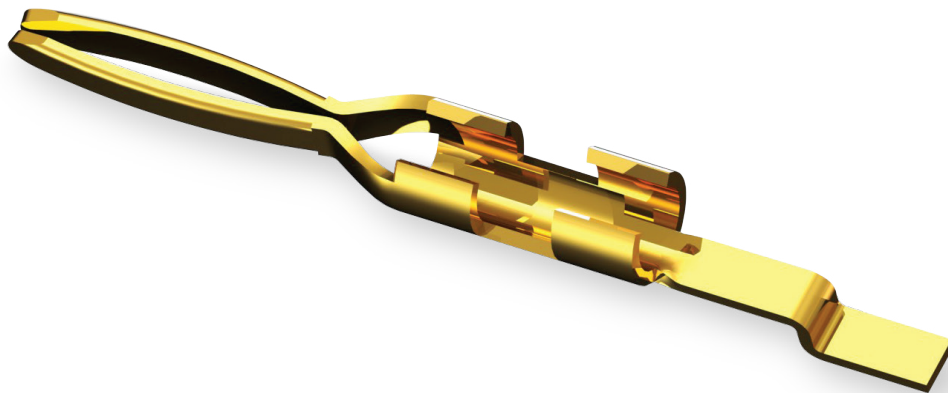

About High Speed

Today's design engineers have a strong directive when it comes to military electronics, and much of the emphasis is focused heavily around SWaP (Size, Weight and Power). The main challenge when designing SWaP-optimized electronics is finding the delicate balance between size, weight, and power consumption, without physically compromising the devices' overall performance, durability, and reliability. Many advanced avionics platforms today are processing mountains of data, and in doing so, are consuming more power than ever before. This requires today's engineers to design embedded electronics and interconnect systems differently, so they can handle increased data speeds and bandwidth without adding significant weight. Omnetics Connector Corporation has been able to lend their expertise to this issue by releasing a new set of miniaturized high-speed standards featuring ruggedized USB 3.1 Gen 1, HDMI and Cat6a Ethernet connector offerings. This new family of miniature circulars allows designers the ability to transmit uninterrupted, high-speed digital signals in some of the smallest Mil-spec footprints on the market.

Table of Contents

USB 3.1 Circular	4
Cat 6a Ethernet Micro	11
Cat 6a Ethernet Nano	18
HDMI Nano	24

USB 3.1 Gen 1 Circular



Electrical-Mechanical Specifications

■ Performance:	Product family tested to and passed or exceeded the performance specifications of Table VIII of MIL-DTL-32139
■ Contact Resistance (Nano):	71 Milliohm Max (71mV Drop Max) @ 1.0 Amps per MIL-DTL-32139
■ Contact Resistance (Micro):	26 Milliohm Max (65 mV Drop Max) @ 2.5 Amps per MIL-DTL-32139
■ Current Rating (Nano):	1 Amp per MIL-DTL-32139
■ Current Rating (Micro):	3 Amps per MIL-DTL-83513
■ Operating Temperature:	-55°C to 85°C
■ Durability:	>2000 mating cycles min
■ Insulation Resistance:	5000 megohms @ 500 VDC
■ Shock:	50 g's with no discontinuities > 10 nanosecond
■ Vibration:	20 g's with no discontinuities > 10 nanosecond
■ Thermal Vacuum Outgassing (Space Class):	1.0% max TML, 0.03% max CVCM
■ Mating/Unmating Force:	2.5 oz (71 g) typical per contact

Material Specifications

■ Contact:	Copper Alloy Per MIL-DTL-32139
■ Contact Finish:	Gold per ASTM B488, Type II, Class 1.27, Code C Over Nickel Underplate
■ Insulator:	Thermoplastic per MIL-M-24519
■ Overmold:	Black Thermoplastic Polyurethane
■ O-Ring:	BUNA-N
■ Cable (Shielded):	30 AWG (7-38) SPC, FEP / 26 AWG (19-38) SPC, FEP color coded, Black Polyurethane Jacket
■ Shield:	Foil wrap with braid - 38 AWG tin plated copper

Shell Options

■ Brass Alloy 360 1/2 Hard:	Electroless Nickel per SAE-AMS-2404 Black Nickel per MIL-P-18317
■ Stainless Steel, 300 Series:	Passivated per SAE-AMS-2700 Black Oxide Finish per MIL-DTL-13924, Class 4*, Passivated per SAE-AMS-2700

* less resistance to salt spray test.

USB 3.1 Gen 1 Circular

Electrical Specifications

Parameter		Spec	1-Meter
Connector Differential Impedance	Z_{MIN}	75 Ω	72 Ω
	Z_{MAX}	105 Ω	100 Ω
Differential Insertion Loss	Loss @ 7.5 GHz	< 25 dB	16 dB
Differential Far-End Crosstalk	FEXT @ 7.5 GHz	< -23 dB	-28 dB
Diff-to-Common Mode Conversion	DCM @ 7.5 GHz	< -20 dB	-20 dB

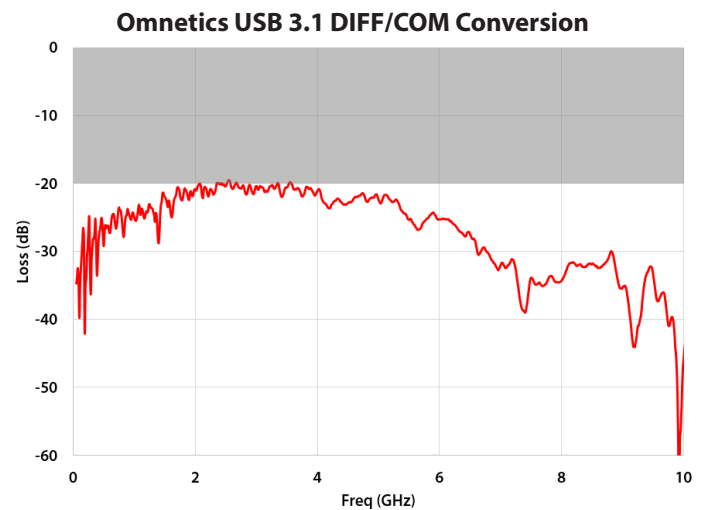
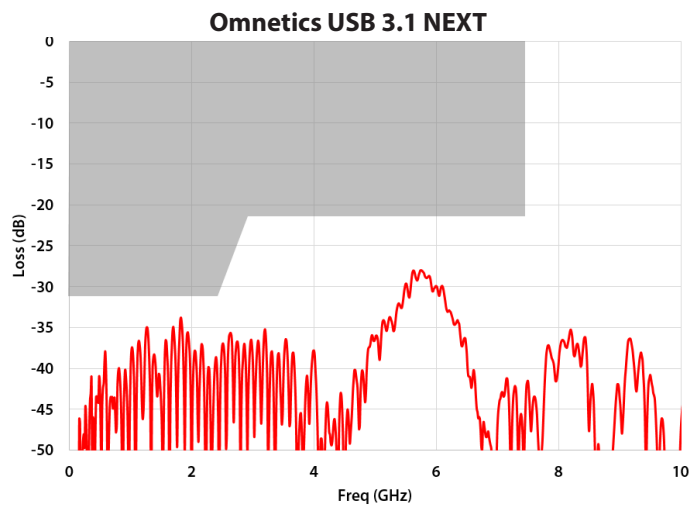
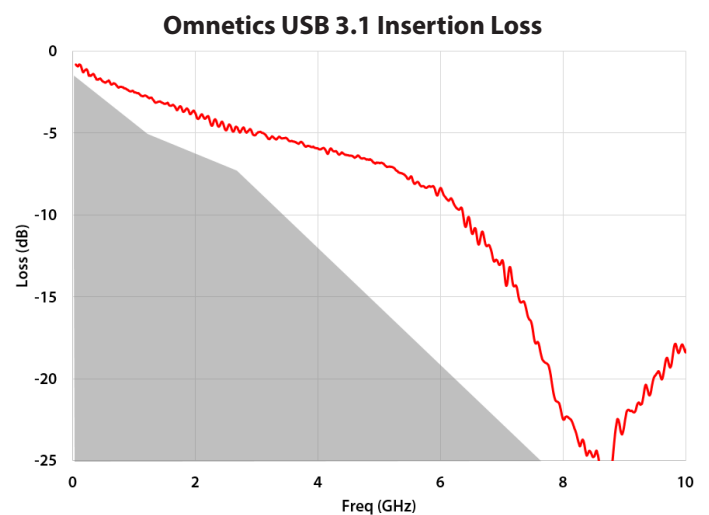
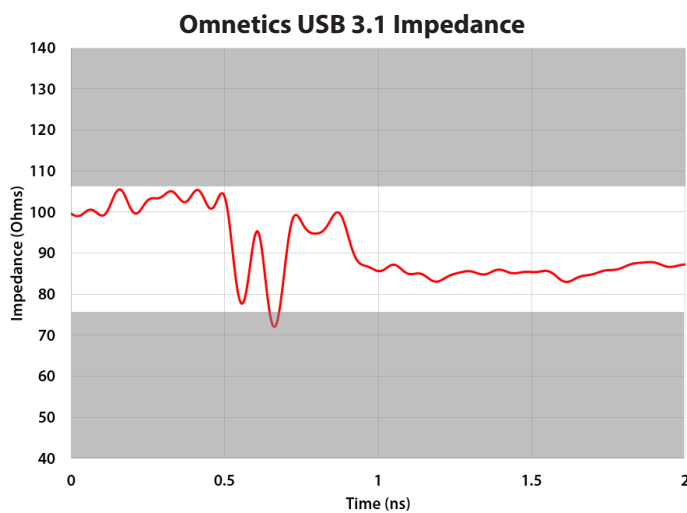

Various cable options are available. Measurements shown above with cables manufactured in Asia.

USB 3.1 Gen 1 Circular Keyed Break Away - KBXP

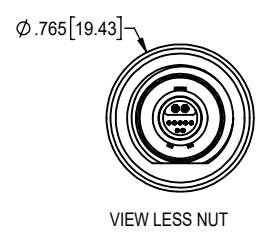
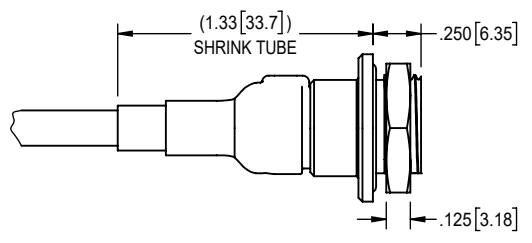
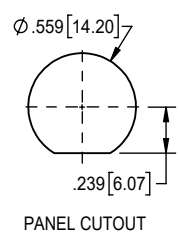
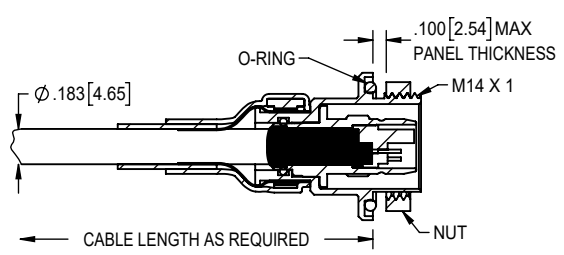
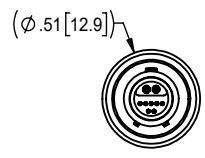
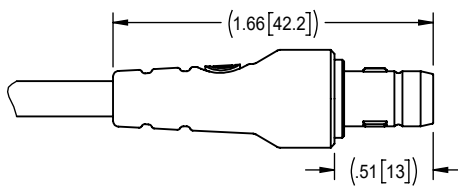
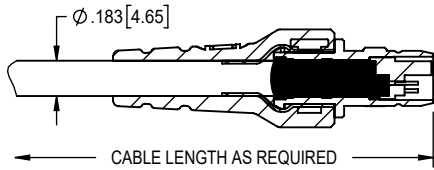

USB 3.1 Gen 1 Circular Keyed Break Away - KBXS

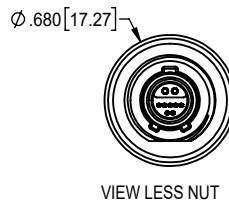
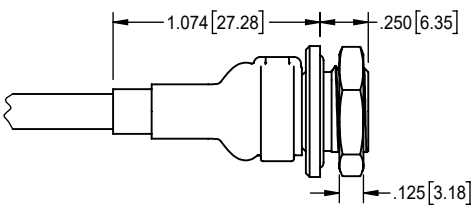
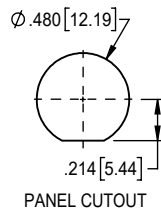
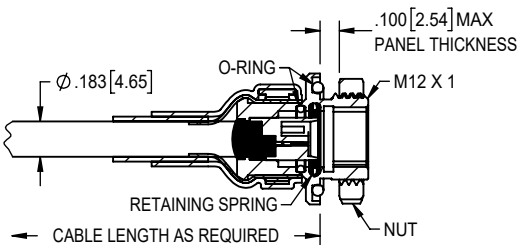
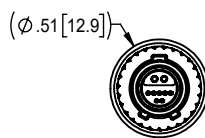
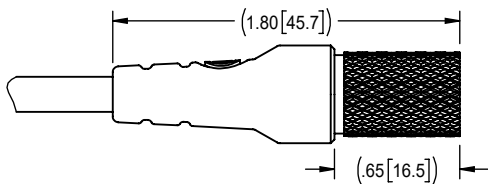
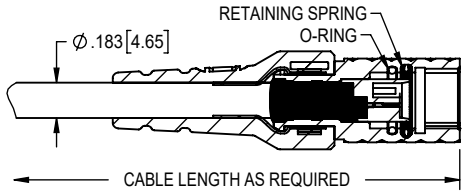

USB PINOUT

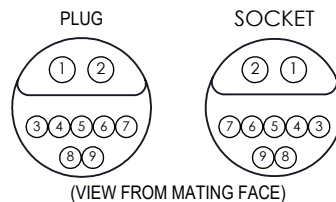

USB 3.1 Gen 1 Circular Threaded - MXC

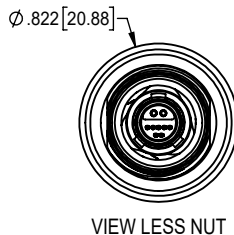
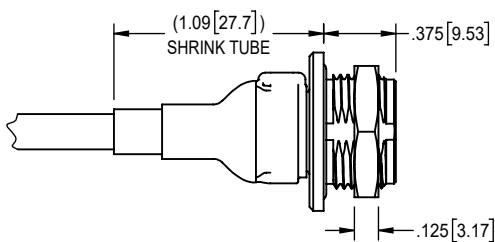
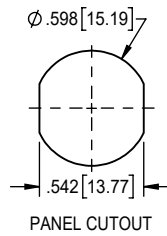
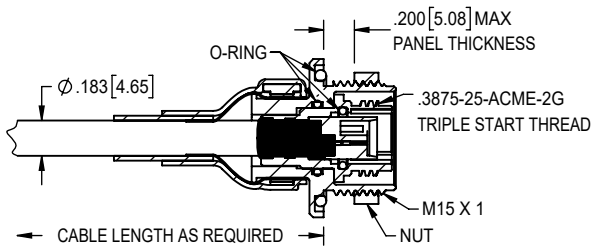
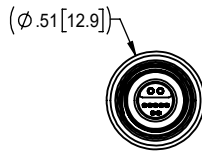
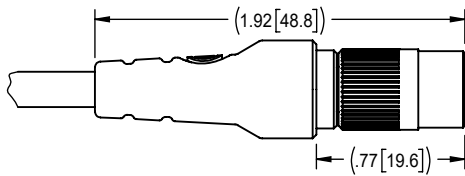
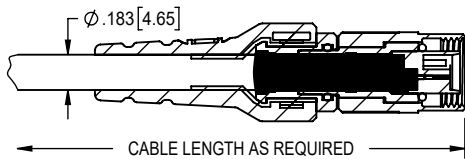
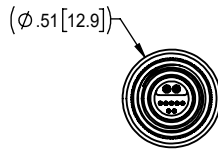
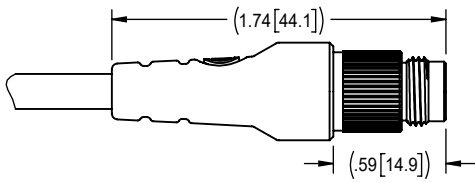
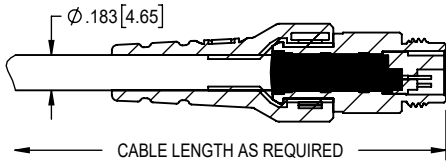

USB 3.1 Gen 1 Circular Triple Threaded - RXC

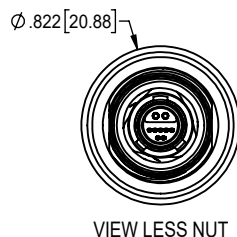
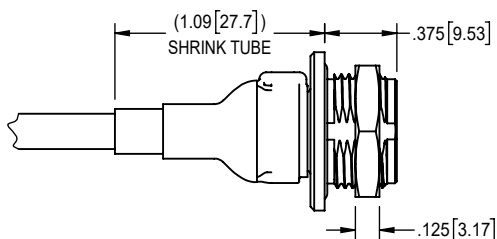
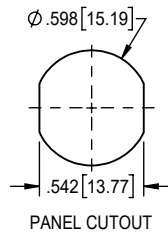
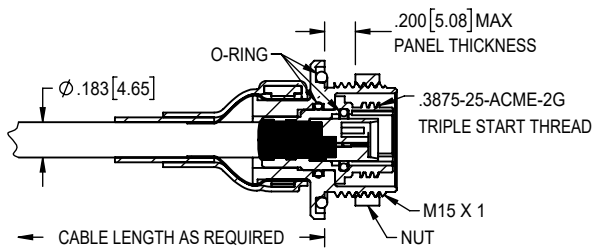
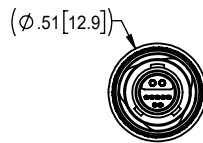
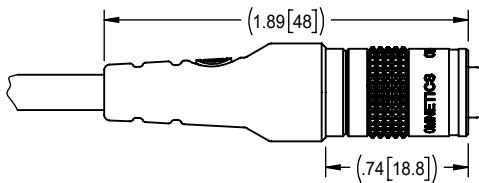
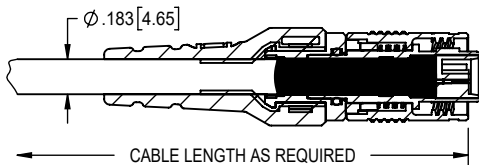
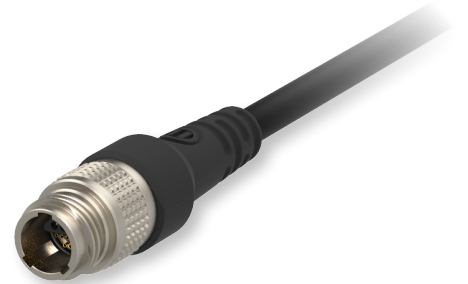
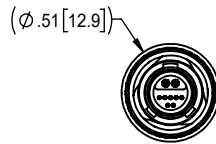
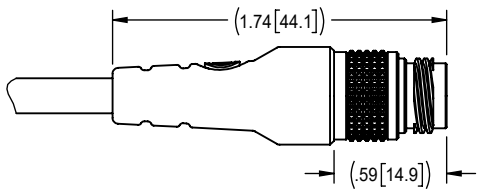
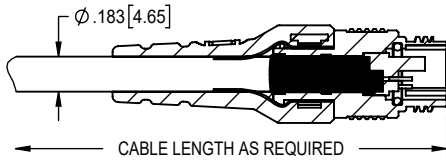

USB 3.1 Gen 1 Circular Twist Lock - TXC

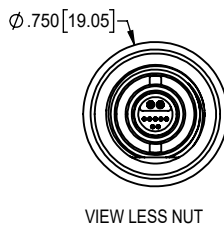
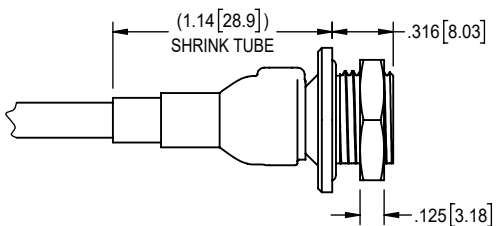
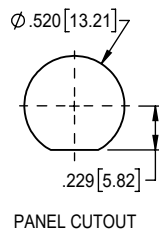
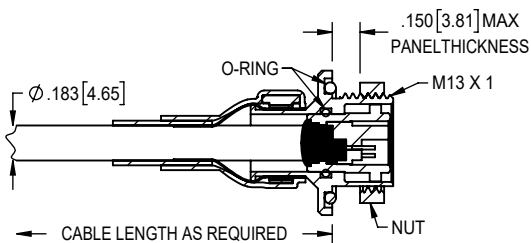
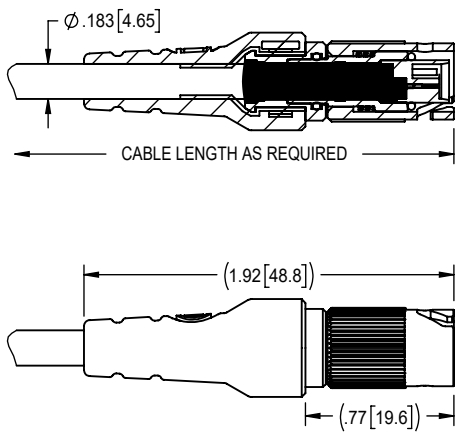
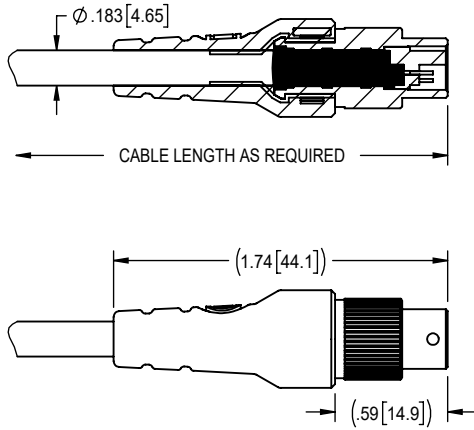

Cat6a Ethernet Micro



Electrical-Mechanical Specifications

- Operating Temperature: _____ -55°C to 85°C
- Dielectric Withstand Voltage: _____ 600 VAC RMS @sea level
- Contact Resistance: _____ 26 milliohms(65 mV) Max @2.5 Amps
- Current Rating: _____ 3 Amps per contact
- Operating Temperature _____ -55°C to 85°C
- Durability: _____ 2000 Mating Cycles min
- Insulation Resistance: _____ 5000 megohms @ 500 VDC
- Shock: _____ 50 g's with no discontinuities > 1 microsecond
- Vibration: _____ 20 g's with no discontinuities > 1 microsecond
- Thermal Vacuum Outgassing (Space Class): _____ 1.0% max TML, 0.03% max CVCM
- Mating/Unmating Force: _____ 3 oz (85 g) per contact

Material Specifications

- Contact: _____ Copper Alloy per MIL-DTL-83513
- Contact Finish: _____ Gold per ASTM B488, Type II, Class 1.27, Code C
Over Nickel Underplate
- Insulator: _____ Thermoplastic per MIL-M-24519
- Overmold: _____ Black Thermoplastic Polyurethane
- Cable (Shielded): _____ 26 AWG (7-34) TPC, HDPE color coded, Black
Polyurethane Jacket
- Shield: _____ Foamed Polypropylene wrap with braid - 38 AWG tin
plated copper

Shell Options

- Stainless Steel, 300 Series: _____ Passivated per SAE-AMS-2700
Black Oxide Finish per MIL-DTL-13924, Class 4*,
Passivated per SAE-AMS-2700
- Brass Alloy 360 1/2 Hard: _____ Electroless Nickel per SAE-AMS-2404
Black Nickel per MIL-P-18317
- Aluminum 6061: _____ Electroless Nickel per SAE-AMS-2404
Black Nickel per MIL-P-18317

* less resistance to salt spray test.

Cat6a Ethernet Micro

Electrical Specifications

Parameter		Spec	1-Meter	3-Meter
Differential Cable Impedance	Z_{MIN}	90 Ω	97 Ω	
	Z_{MAX}	110 Ω	98 Ω	
Differential Insertion Loss	Loss @ 500 MHz	< 44 dB	1 dB	3 dB
Differential Return Loss	Loss @ 500 MHz	< -8 dB	-13 dB	-14 dB
Differential Far-End Crosstalk	NEXT @ 500 MHz	< -27 dB	-48 dB	-53 dB
Differential Power Sum Far-End Crosstalk	PSNEXT @ 500 MHz	< -24 dB	-45 dB	-50 dB

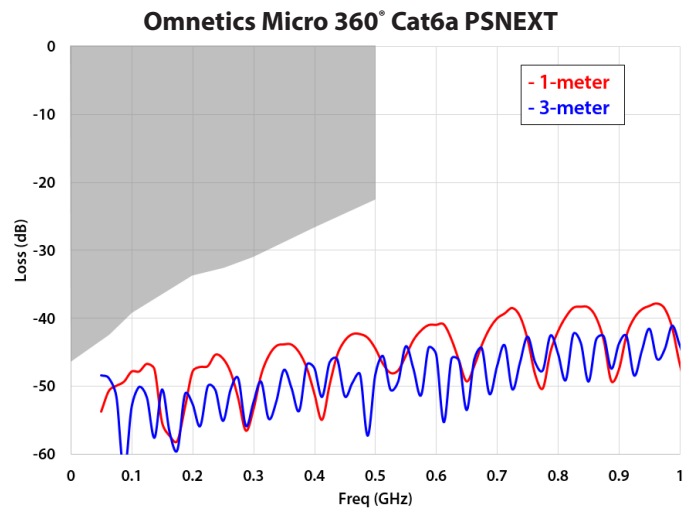
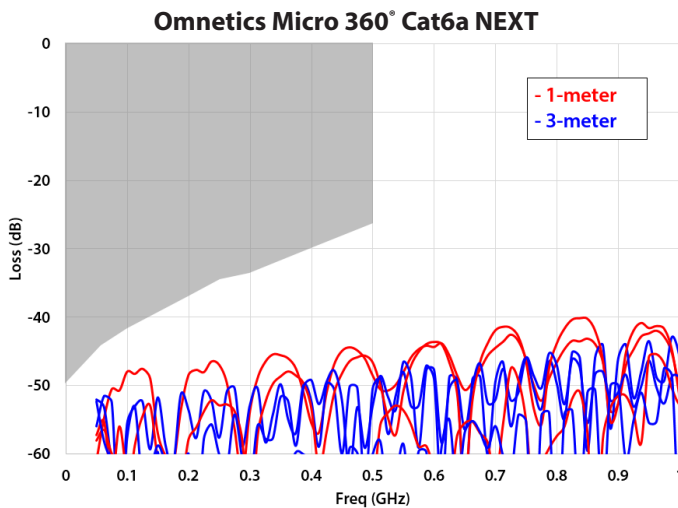
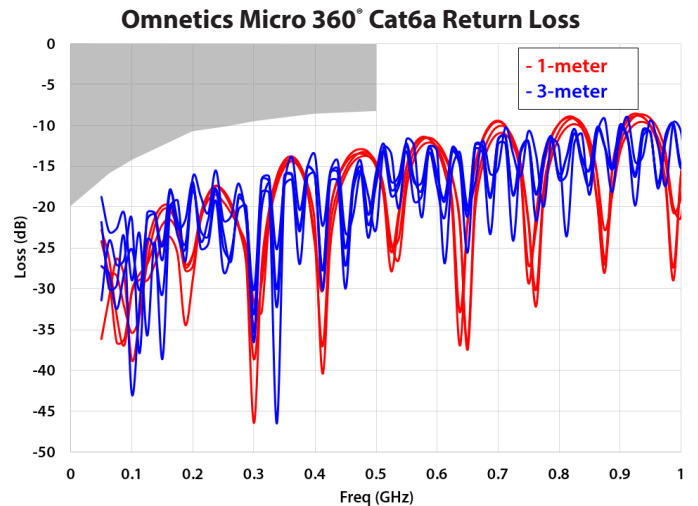
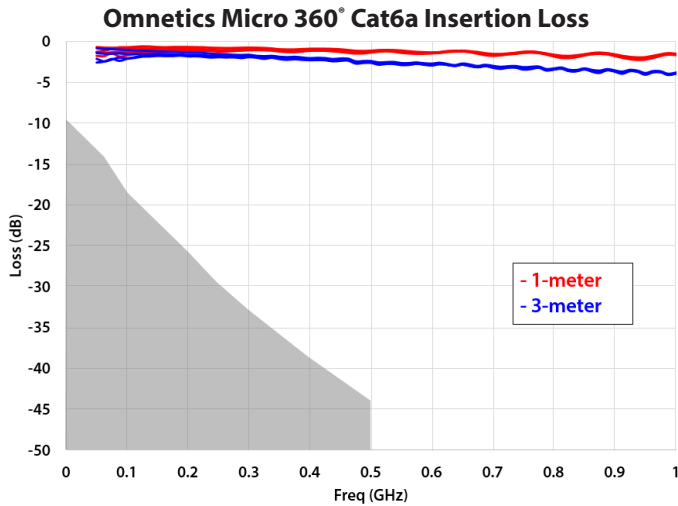

Various cable options are available. Measurements shown above with cables manufactured in Asia.

Cat6a Ethernet Micro Circular Keyed Break Away - KBMP

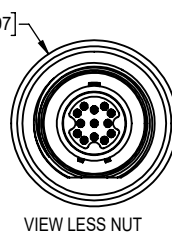
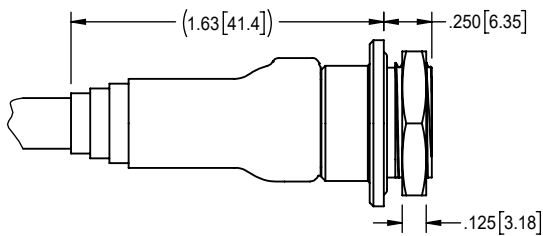
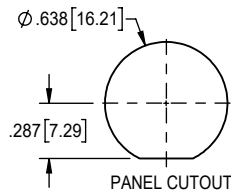
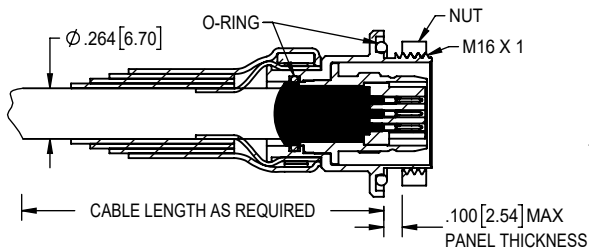
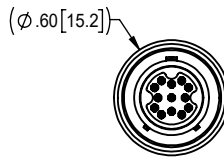
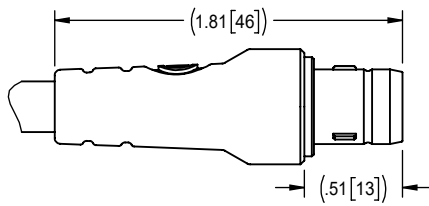
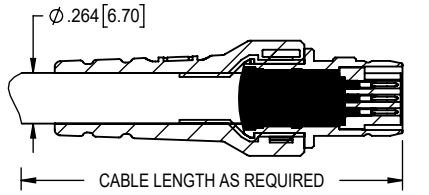

Cat6a Ethernet Micro Circular Keyed Break Away - KBMS

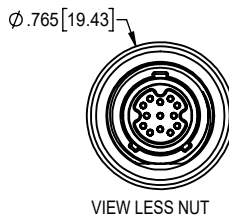
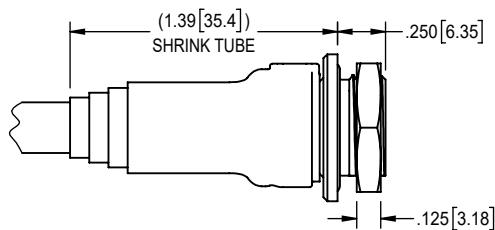
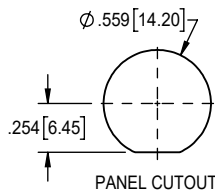
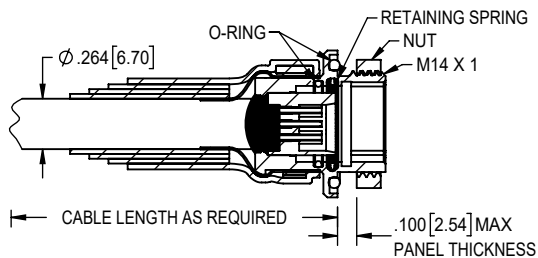
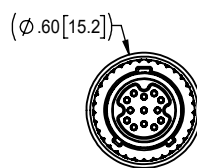
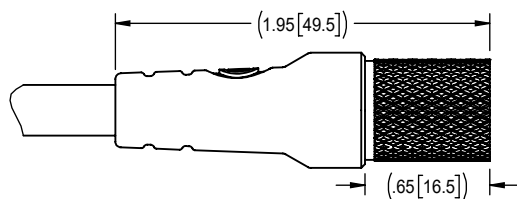
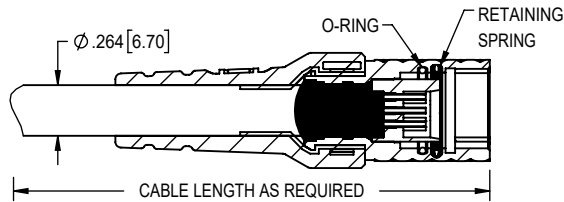

ETHERNET PINOUT

PLUG

SOCKET

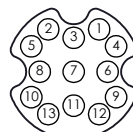

(VIEW FROM MATING FACE)

Cat6a Ethernet Micro Circular Threaded - MMC

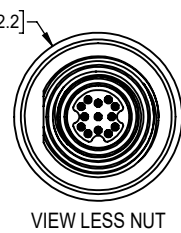
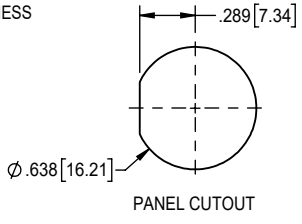
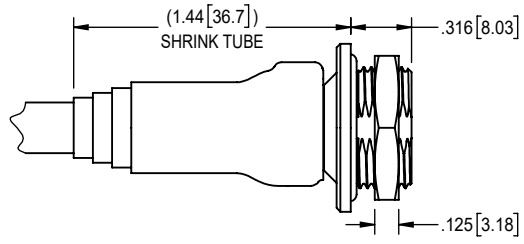
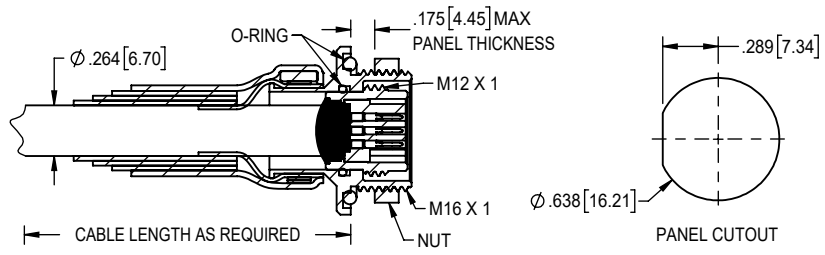
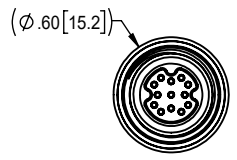
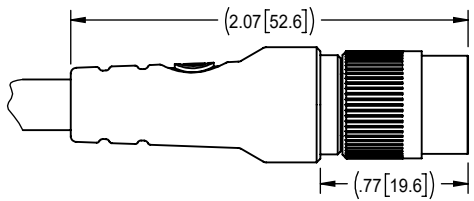
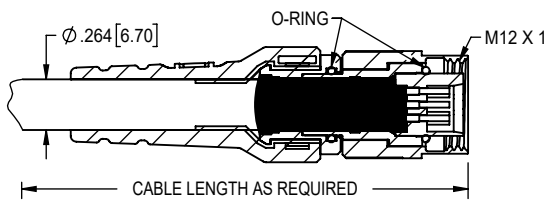
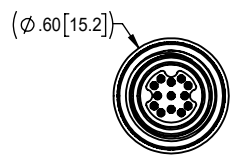
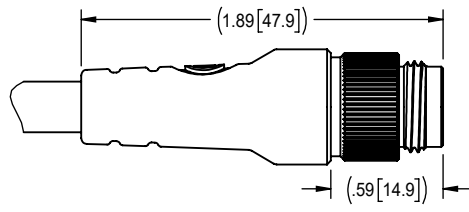
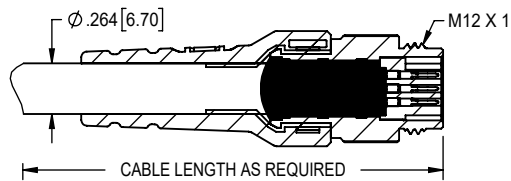

Cat6a Ethernet Micro Circular Ratcheting - RMC

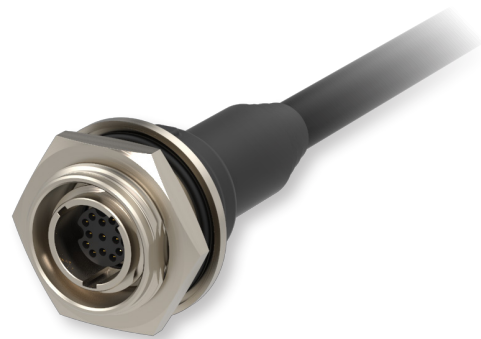
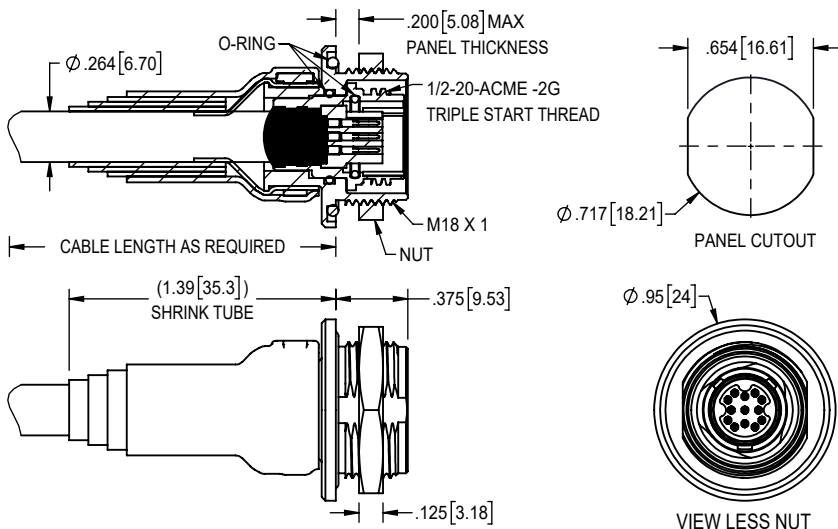
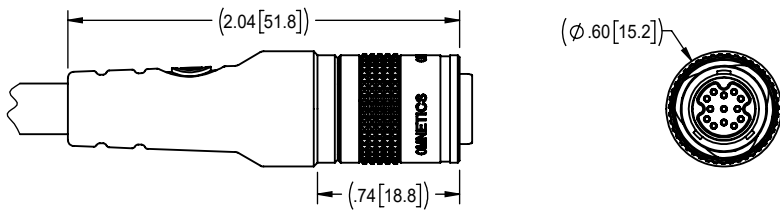
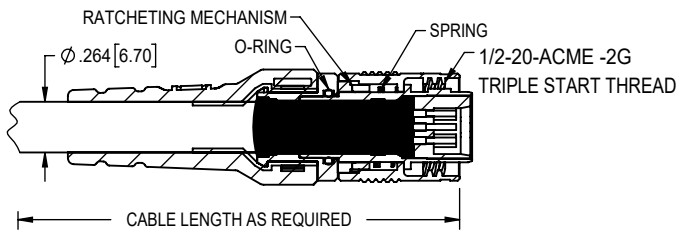
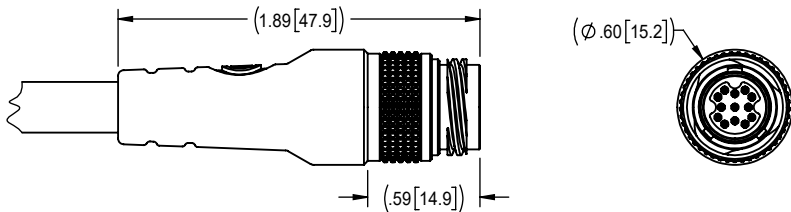
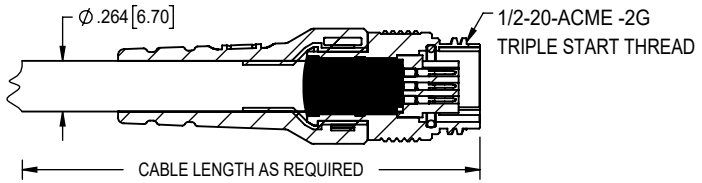

Cat6a Ethernet Micro Circular Twist Lock - TMC

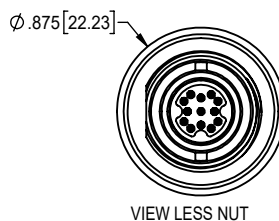
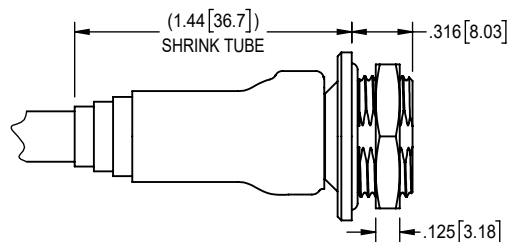
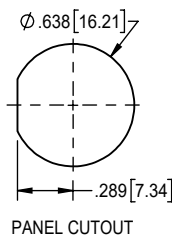
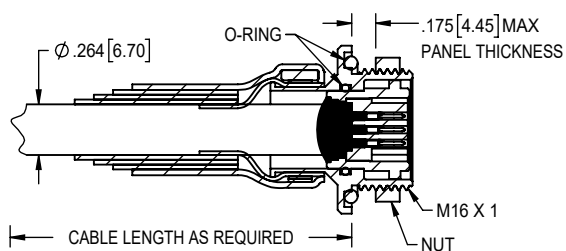
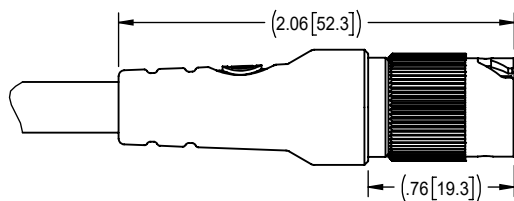
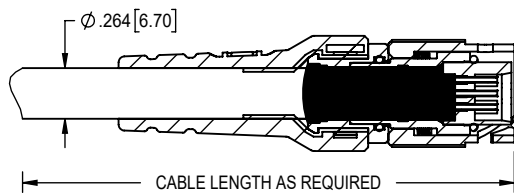
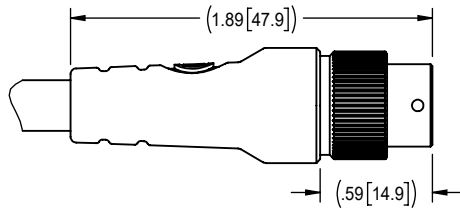
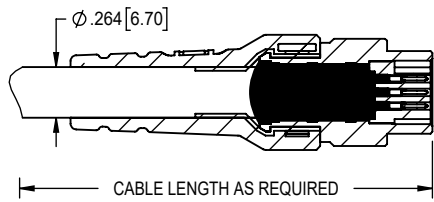

Cat6a Ethernet Nano



Electrical-Mechanical Specifications

- Performance: _____ Product family tested to and passed or exceeded the performance specifications of Table VIII of MIL-DTL-32139
- Contact Resistance: _____ 71 Milliohm Max (71mV Drop Max) @ 1.0 Amps per MIL-DTL-32139
- Current Rating: _____ 1 Amp per MIL-DTL-32139
- Operating Temperature: _____ -55°C to 85°C
- Durability: _____ >2000 mating cycles min
- Insulation Resistance: _____ 5000 megohms @ 100 VDC
- Shock: _____ 100 g's with no discontinuities > 10 nanosecond
- Vibration: _____ 20 g's with no discontinuities > 10 nanosecond
- Thermal Vacuum Outgassing (Space Class): _____ 1.0% max TML, 0.03% max CVCM
- Mating/Unmating Force: _____ 2.5 oz (71 g) typical per contact

Material Specifications

- Contact: _____ Copper Alloy Per MIL-DTL-32139
- Contact Finish: _____ Gold per ASTM B488, Type II, Class 1.27, Code C Over Nickel Underplate
- Insulator: _____ Thermoplastic per MIL-M-24519
- Overmold: _____ Black Thermoplastic Polyurethane
- O-Ring: _____ BUNA-N
- Cable (Shielded): _____ 32 AWG (7-40) SPC, FEP color coded, Black Polyurethane Jacket
- Shield: _____ Aluminum/Poly wrap with braid - 40 AWG tin plated copper

Shell Options

- Brass Alloy 360 1/2 Hard: _____ Electroless Nickel per SAE-AMS-2404
Black Nickel per MIL-P-18317
- Stainless Steel, 300 Series: _____ Passivated per SAE-AMS-2700
Black Oxide Finish per MIL-DTL-13924, Class 4*, Passivated per SAE-AMS-2700

* less resistance to salt spray test.

Cat6a Ethernet Nano

Electrical Specifications

Parameter		Spec	1-Meter	3-Meter
Differential Cable Impedance	Z_{MIN}	90 Ω	96 Ω	
	Z_{MAX}	110 Ω	99 Ω	
Differential Insertion Loss	Loss @ 500 MHz	< 44 dB	1 dB	3 dB
Differential Return Loss	Loss @ 500 MHz	< -8 dB	-16 dB	-17 dB
Differential Far-End Crosstalk	NEXT @ 500 MHz	< -27 dB	-50 dB	-51 dB
Differential Power Sum Far-End Crosstalk	PSNEXT @ 500 MHz	< -24 dB	-48 dB	-49 dB

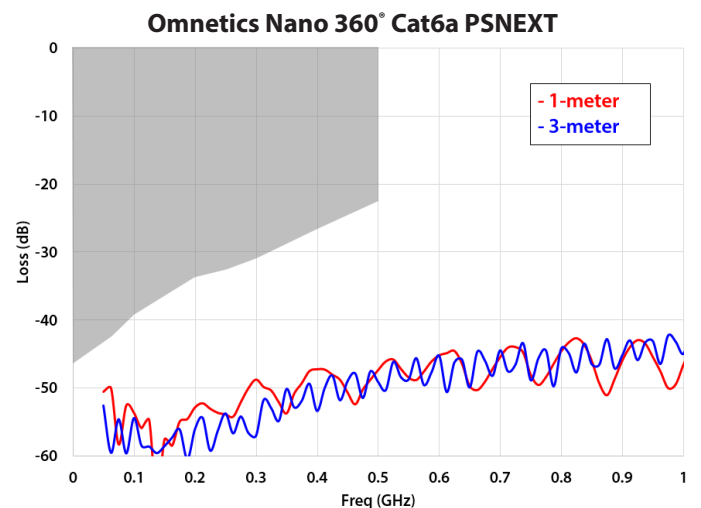
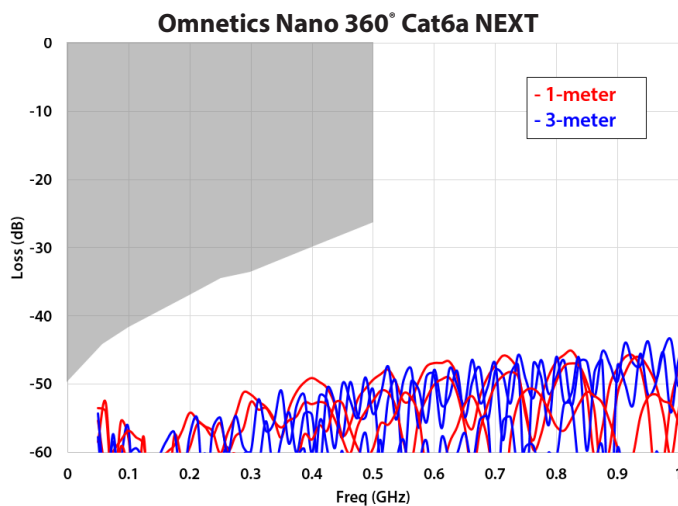
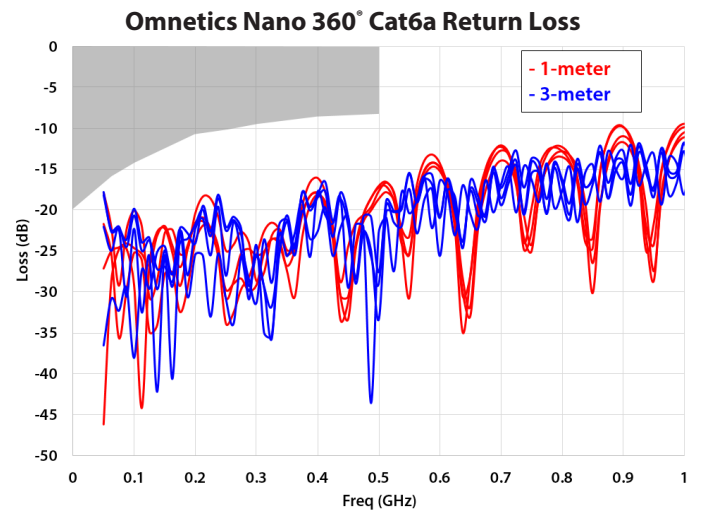
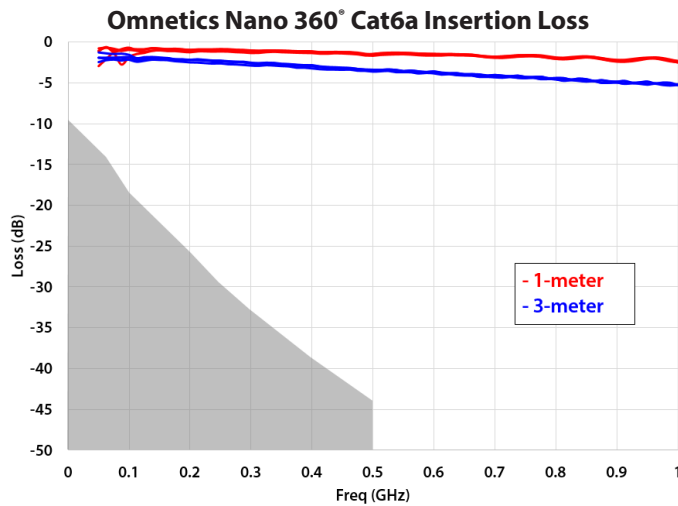

Various cable options are available. Measurements shown above with cables manufactured in Asia.

Cat6a Ethernet Nano Circular Keyed Break Away - KBNP

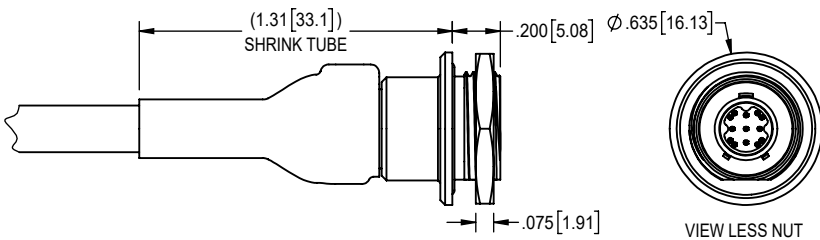
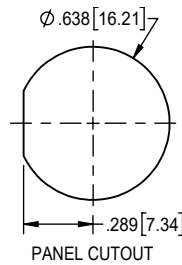
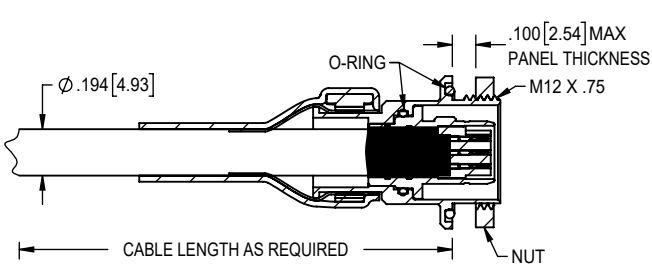
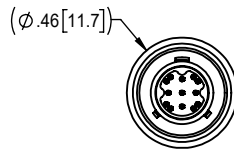
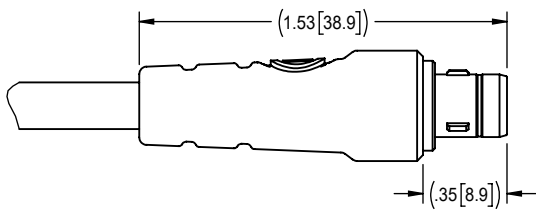
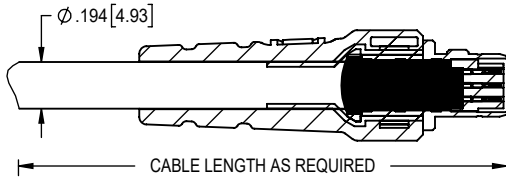

Cat6a Ethernet Nano Circular Keyed Break Away - KBNS

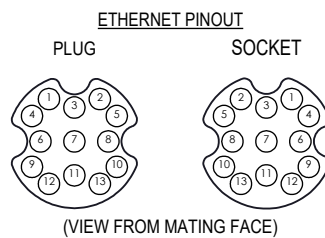
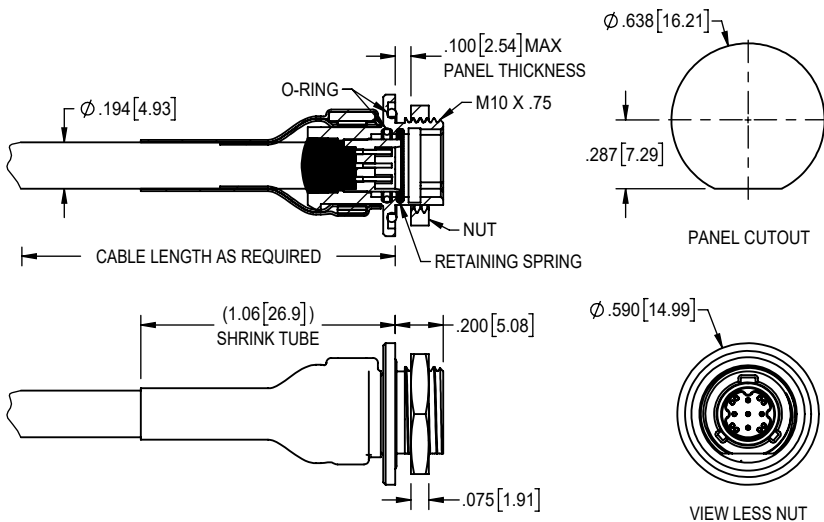
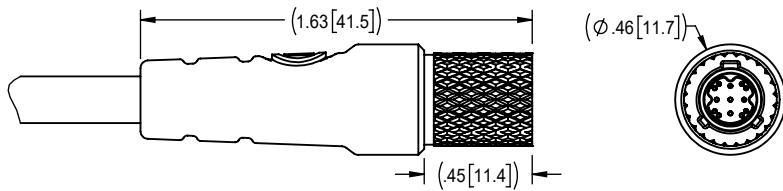
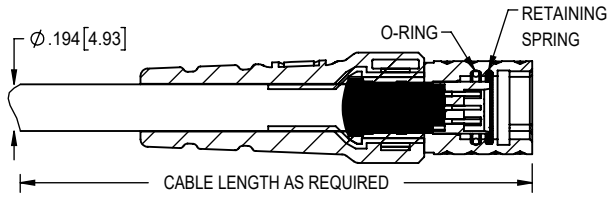

Cat6a Ethernet Nano Circular Threaded - MNC

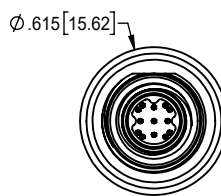
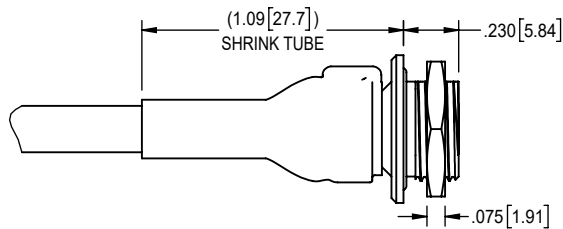
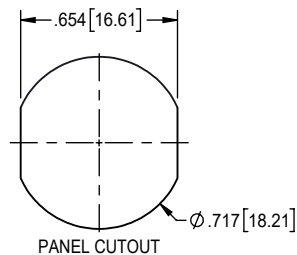
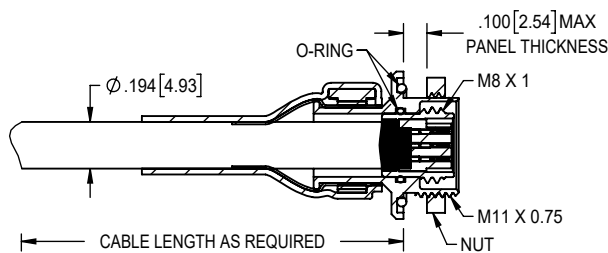
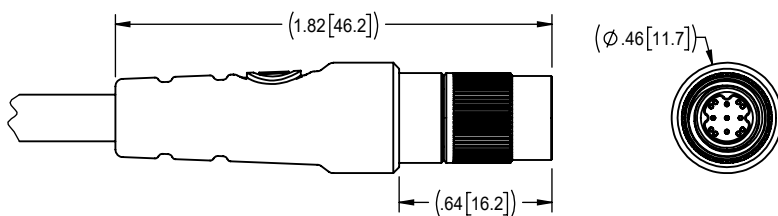
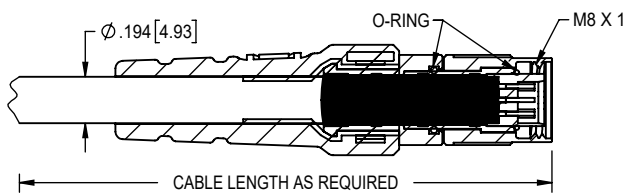
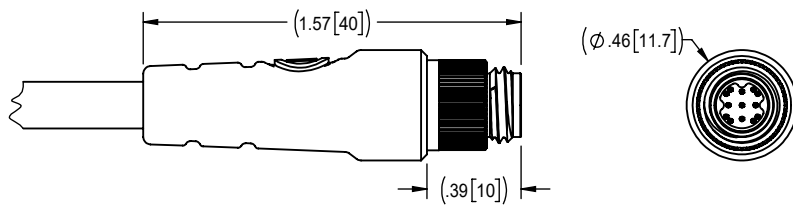
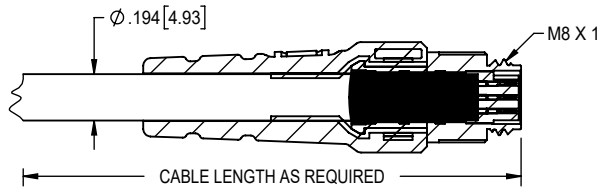

VIEW LESS NUT



Cat6a Ethernet Nano Circular Twist Lock - TNC

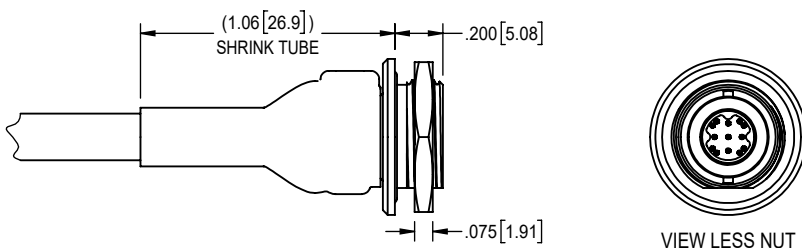
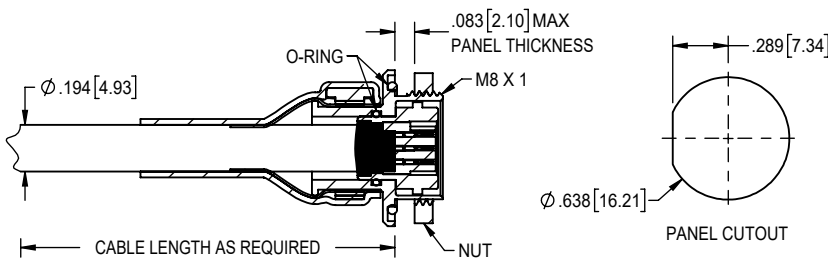
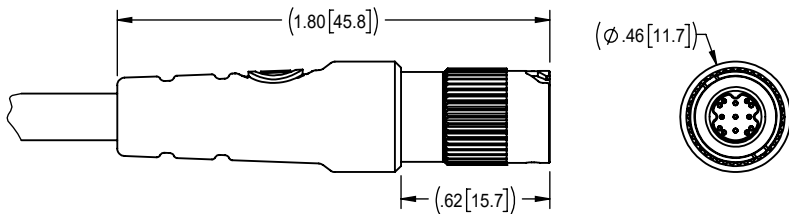
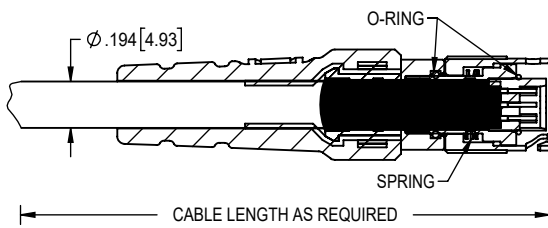
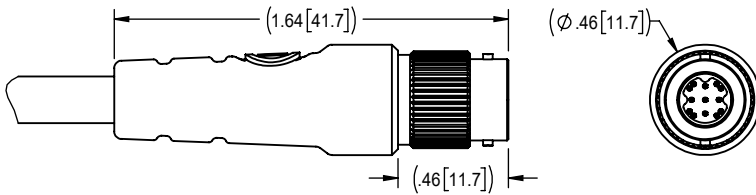
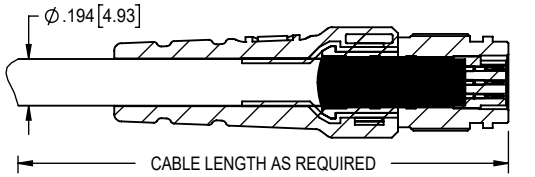

HDMI Nano



Electrical-Mechanical Specifications

■ Performance:	_____	Product family tested to and passed or exceeded the performance specifications of Table VIII of MIL-DTL-32139
■ Contact Resistance:	_____	71 Milliohm Max (71mV Drop Max) @ 1.0 Amps per MIL-DTL-32139
■ Current Rating:	_____	1 Amp per MIL-DTL-32139
■ Operating Temperature:	_____	-55°C to 85°C
■ Durability:	_____	>2000 mating cycles min
■ Insulation Resistance:	_____	5000 megohms @ 100 VDC
■ Shock:	_____	100 g's with no discontinuities > 10 nanosecond
■ Vibration:	_____	20 g's with no discontinuities > 10 nanosecond
■ Thermal Vacuum Outgassing (Space Class):	_____	1.0% max TML, 0.03% max CVCM
■ Mating/Unmating Force:	_____	2.5 oz (71 g) typical per contact

Material Specifications

■ Contact:	_____	Copper Alloy Per MIL-DTL-32139
■ Contact Finish:	_____	Gold per ASTM B488, Type II, Class 1.27, Code C Over Nickel Underplate
■ Insulator:	_____	Thermoplastic per MIL-M-24519
■ Overmold:	_____	Black Thermoplastic Polyurethane
■ O-Ring:	_____	BUNA-N
■ Cable (Shielded):	_____	32 AWG (7-40) SPA, EPTFE/PFA, color coded, Black Polyurethane Jacket
■ Shield:	_____	Mylar foil wrap, 38 AWG tin plate copper braiding

Shell Options

■ Brass Alloy 360 1/2 Hard:	_____	Electroless Nickel per SAE-AMS-2404 Black Nickel per MIL-P-18317
■ Stainless Steel, 300 Series:	_____	Passivated per SAE-AMS-2700 Black Oxide Finish per MIL-DTL-13924, Class 4*, Passivated per SAE-AMS-2700

* less resistance to salt spray test.

HDMI Nano

Electrical Specifications

Parameter		Spec	1-Meter	3-Meter
Connector Differential Impedance	Z_{MIN}	75 Ω	85 Ω	87 Ω
	Z_{MAX}	125 Ω	108 Ω	110 Ω
Cable Differential Impedance	Z_{MIN}	90 Ω	95 Ω	95 Ω
	Z_{MAX}	100 Ω	104 Ω	103 Ω
Differential Insertion Loss	0.825 GHz	5 dB	2 dB	5 dB
	2.475 GHz	12 dB	5 dB	9 dB
	4.125 GHz	20 dB	7 dB	12 dB
	5.100 GHz	25 dB	9 dB	15 dB
Differential Far-End Crosstalk	FEXT MAX	< -20 dB	-32 dB	-38 dB
Intra-Pair Skew	Skew MAX	112 ps	34 ps	79 ps

Omnetics Nano 360° HDMI Connector Impedance

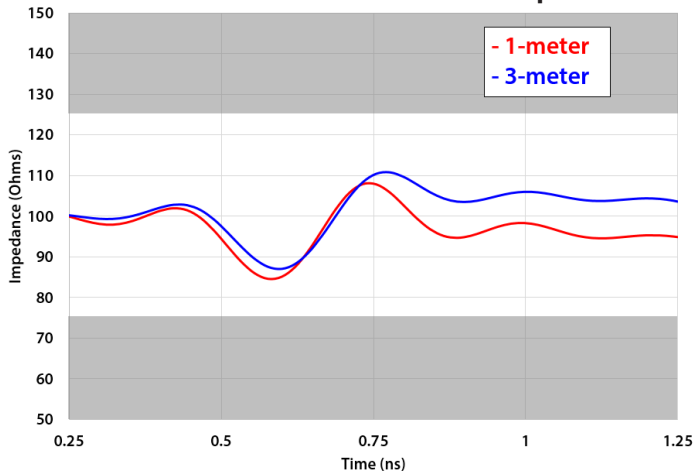

Omnetics Nano 360° HDMI Insertion Loss

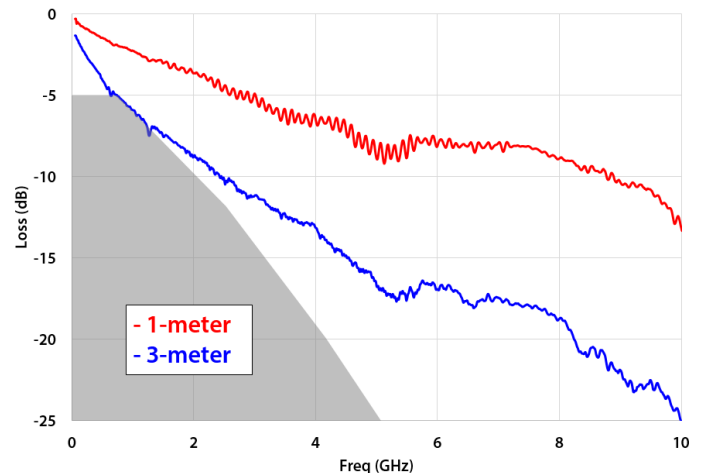

Omnetics Nano 360° HDMI FEXT

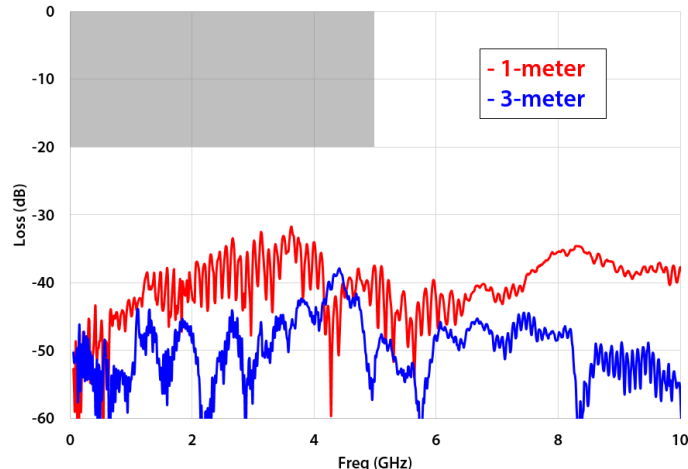

Omnetics Nano 360° HDMI TDT

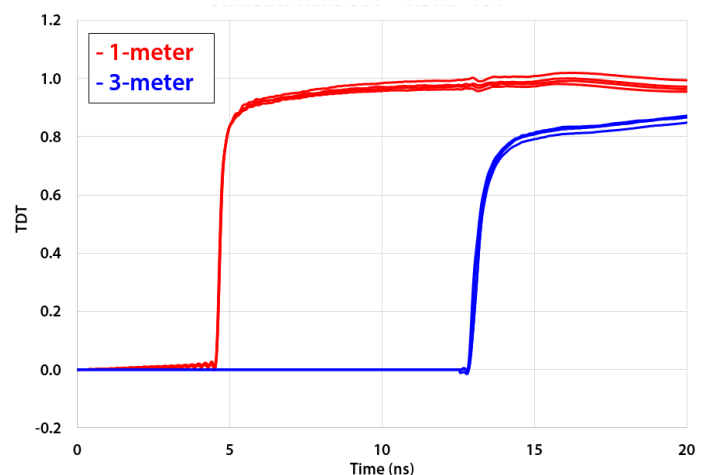

Various cable options are available. Measurements shown above with cables manufactured in Asia.

HDMI Nano Circular Keyed Break Away - KBNP

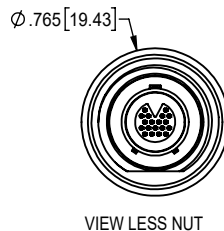
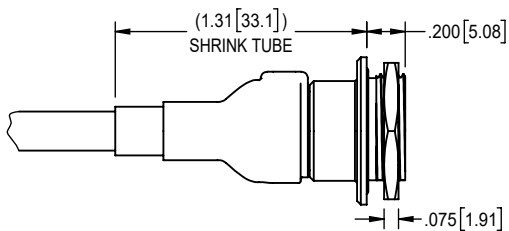
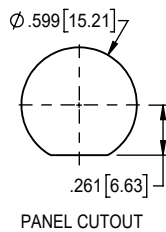
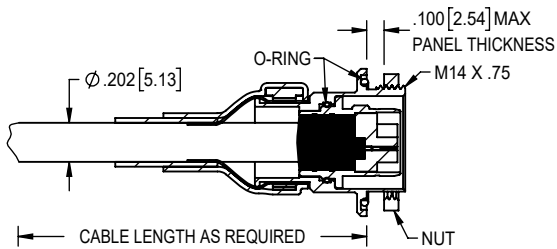
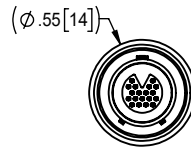
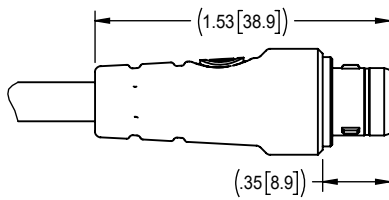
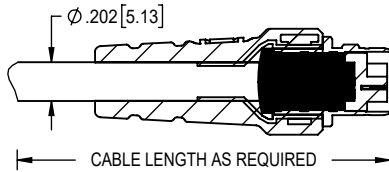

HDMI Nano Circular Keyed Break Away - KBNS

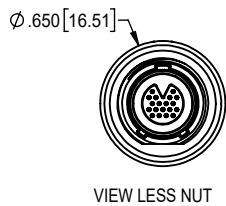
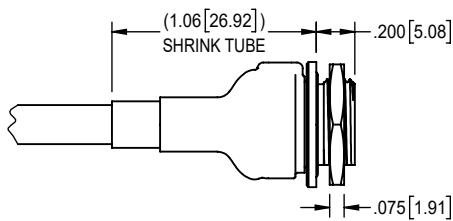
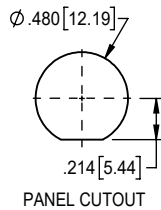
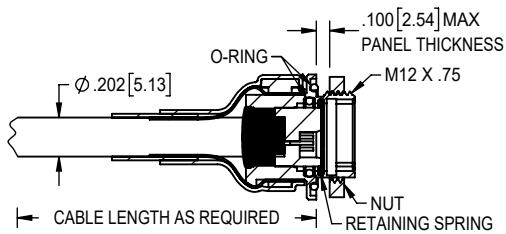
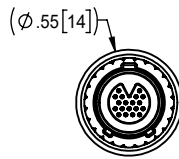
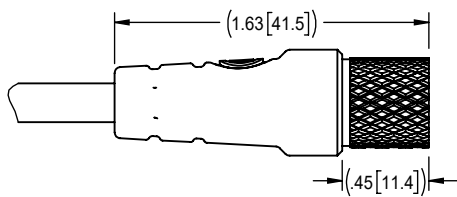
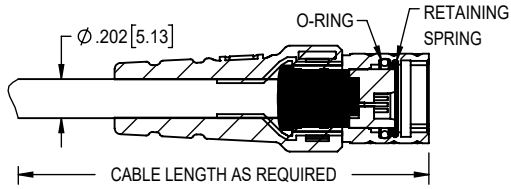

HDMI PINOUT

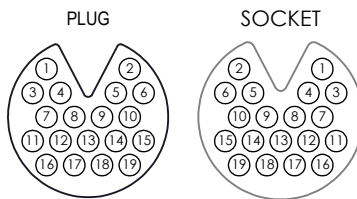

HDMI Nano Circular Threaded - MNC

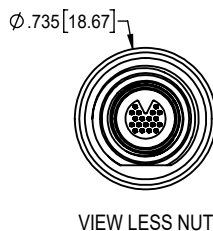
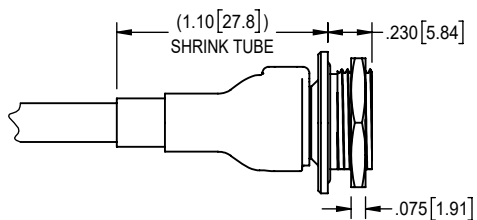
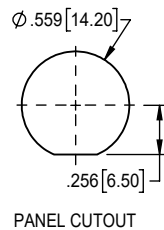
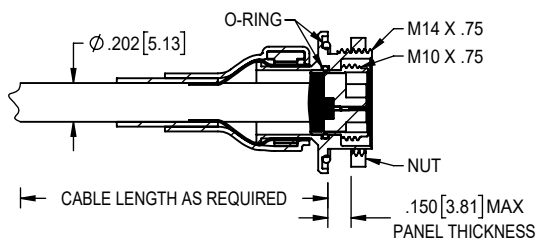
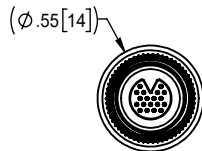
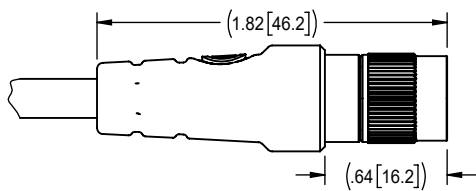
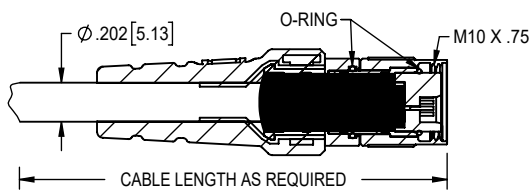
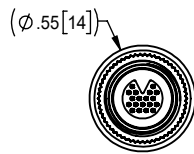
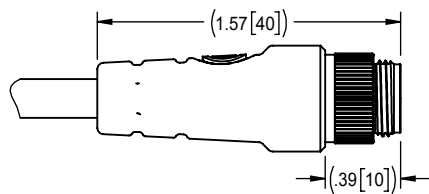
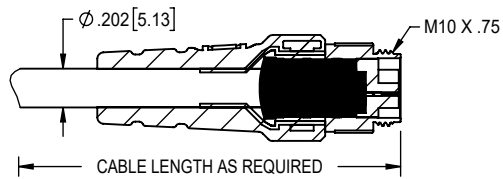

HDMI Nano Circular

Twist Lock - TNC

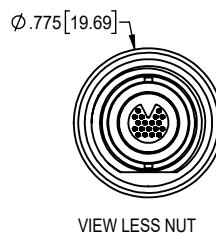
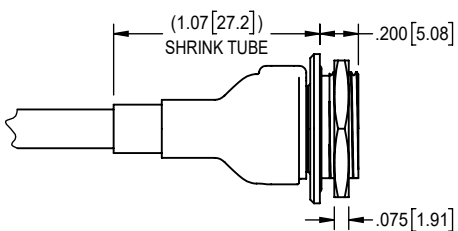
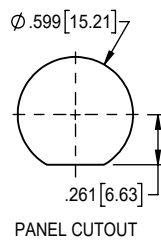
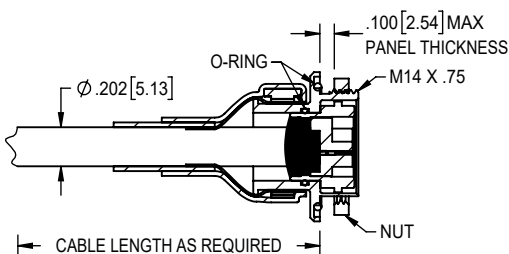
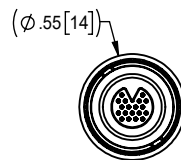
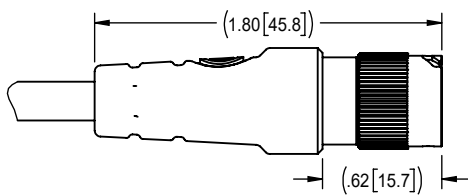
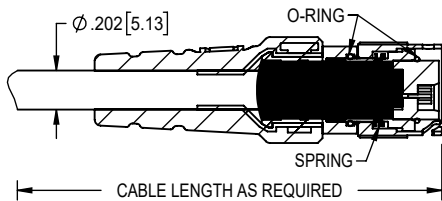
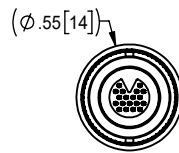
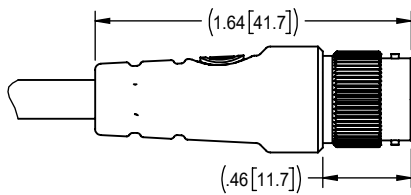
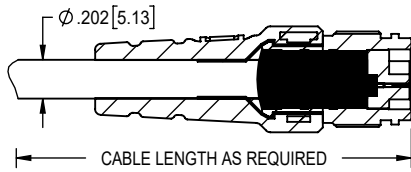

See our other miniature and ruggedized connector options at www.omnetics.com!

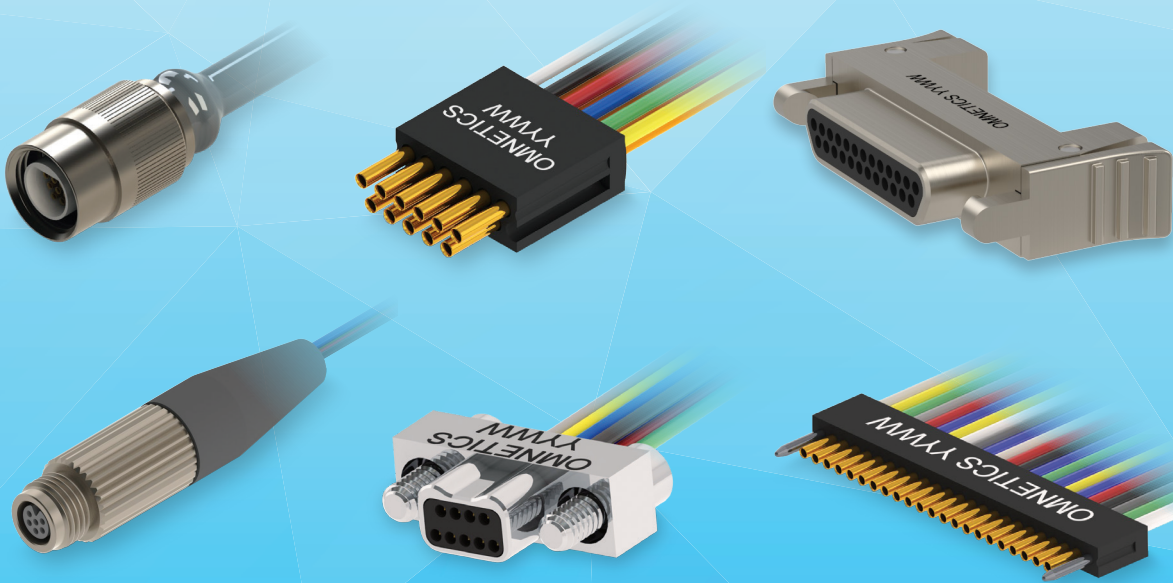

Omnetics Connector Corporation | 7260 Commerce Circle East | Minneapolis, MN 55432

Ph: 763-572-0656 | Fax: 763-572-3925 | www.omnetics.com | sales@omnetics.com

© 2019 Omnetics Connector Corporation REV 1



OMNETICS
CONNECTOR CORPORATION