

# PLANAR 814/1

## Vector Network Analyzer

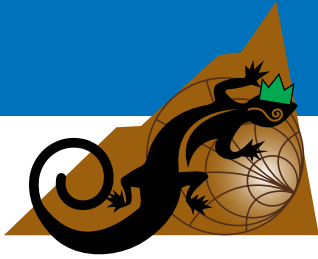

COPPER MOUNTAIN  
TECHNOLOGIES

### End of Sale: 1 October 2019

This product will be unavailable for purchase from 1 October 2019. CMT will continue to provide technical assistance for 3 years following the EOS date.

The Cobalt C2209 2 Port 9 GHz Analyzer is the recommended alternative for the Planar 814/1



#### KEY FEATURES

- ▶ Frequency range: 100 kHz – 8 GHz
- ▶ Measured parameters: S11, S12, S21, S22
- ▶ Wide output power range: -60 dBm to +10 dBm
- ▶ >150 dB dynamic range (1 Hz IF bandwidth)
- ▶ Direct access to receivers
- ▶ Time domain and gating conversion included
- ▶ Fixture simulation
- ▶ Frequency offset mode, including vector mixer calibration measurements
- ▶ Up to 500,001 measurement points
- ▶ Measurement time per point: 100  $\mu$ s per point
- ▶ Up to 16 logical channels with 16 traces each
- ▶ Multiple precision calibration methods and automatic calibration
- ▶ COM/DCOM compatible for LabView and automation programming



COPPER MOUNTAIN TECHNOLOGIES

US Office: +1.317.222.5400 | Singapore Office: +65.63.23.6546

[coppermountaintech.com](http://coppermountaintech.com)

# Real Performance, Real Value.

## Advanced

CMT analyzers take advantage of breakthrough advances in RF technology as well as the faster processing power, larger display, and more reliable performance of an external PC, while also simplifying maintenance of the analyzer.

## Accurate

Our VNAs are made with high standards. Every instrument is lab-grade quality, with a wide dynamic range, low noise floor, high resolution sweep, and a variety of other advanced features. The metrology of the Planar 814/1 delivers real measurement accuracy and reliability.

## Cost Effective

CMT VNAs are flexible, easy to maintain, and are well-suited for lab, production, field, and secure testing environments. With every bit of performance of traditional analyzers, but at a fraction of the cost, now every engineer and technician can have a highly accurate VNA.





The Planar 814/1 VNA is an S-parameter vector network analyzer designed for operation with an external PC. It connects to any Windows-based computer via USB and delivers accurate testing and measurement through a platform that can keep up with constant advancements as well as be remotely accessed.

This analyzer is an excellent solution for performing the full range of magnitude and phase measurements over the frequency from 100 kHz to 8.0 GHz. The following product brochure outlines the various features that are standard on the device.

### Front Panel

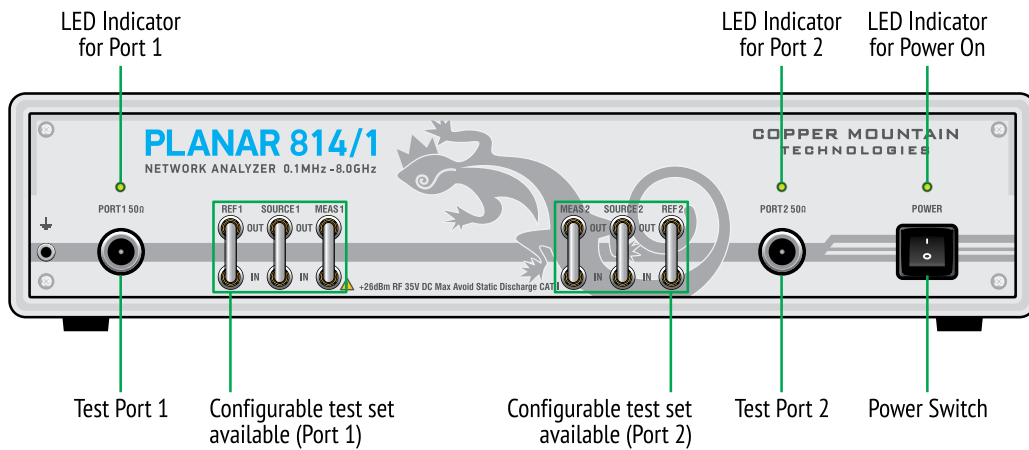

### Rear Panel

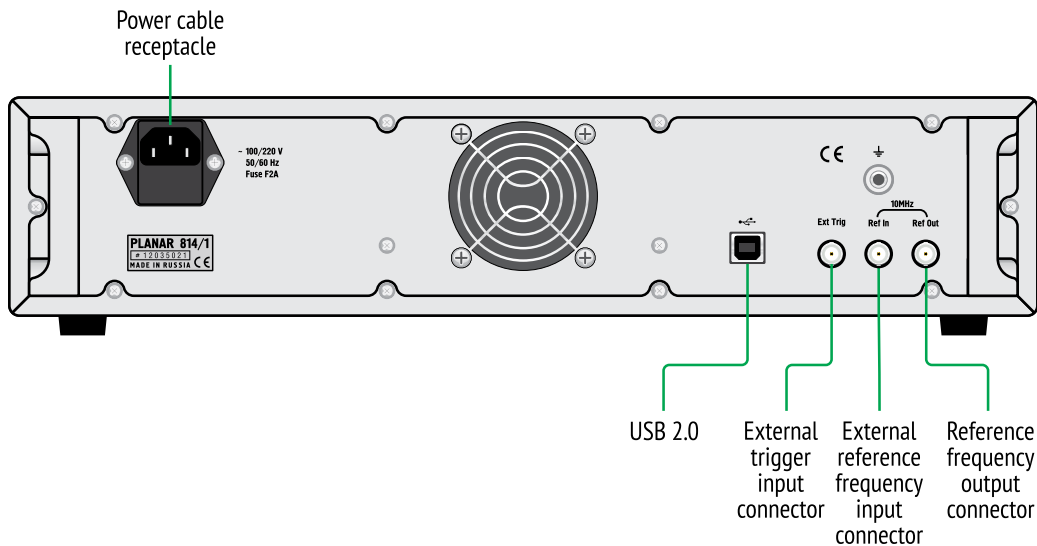

### Schematic Diagram of Planar 814/1

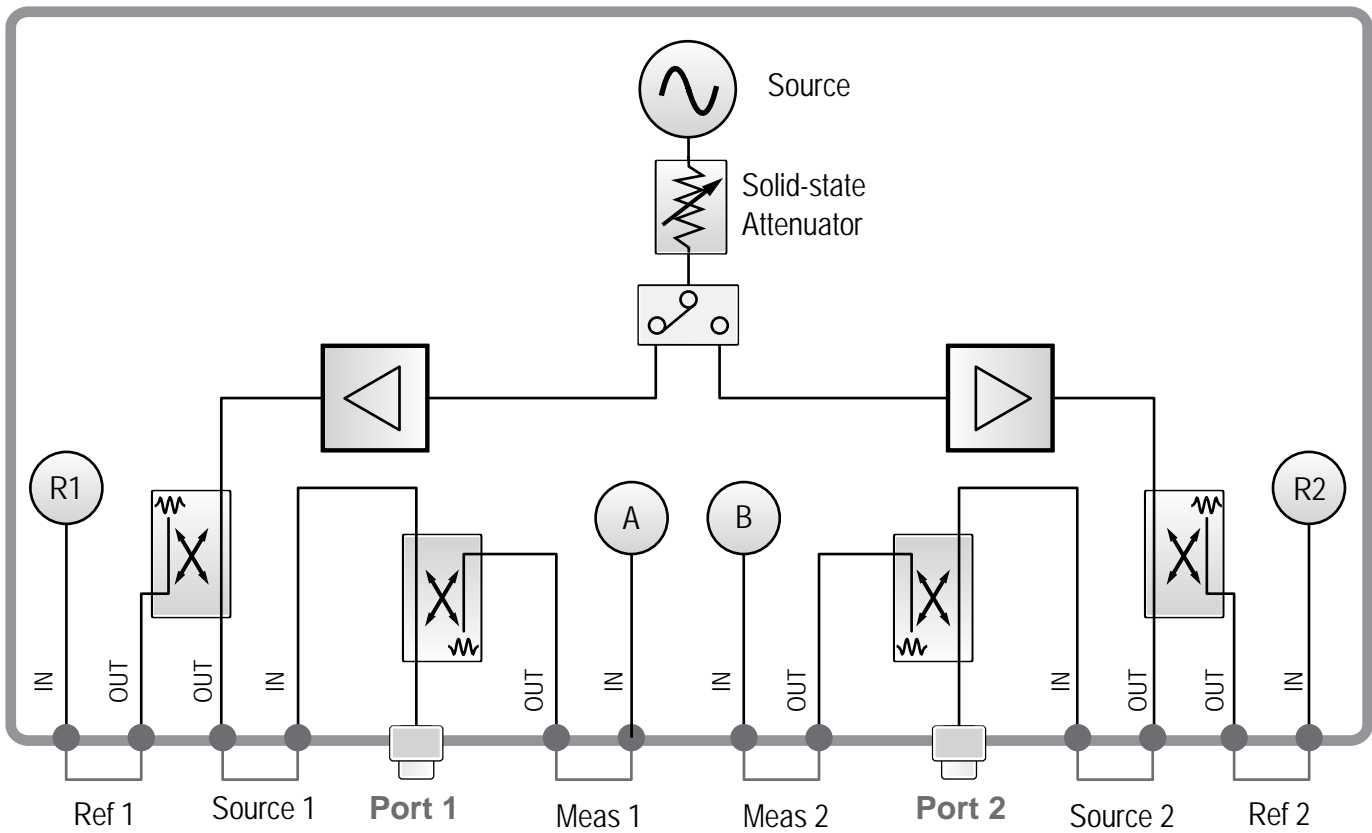

This 2-port analyzer offers adjustable port configuration with direct access to the receivers.

## Measurement Capabilities

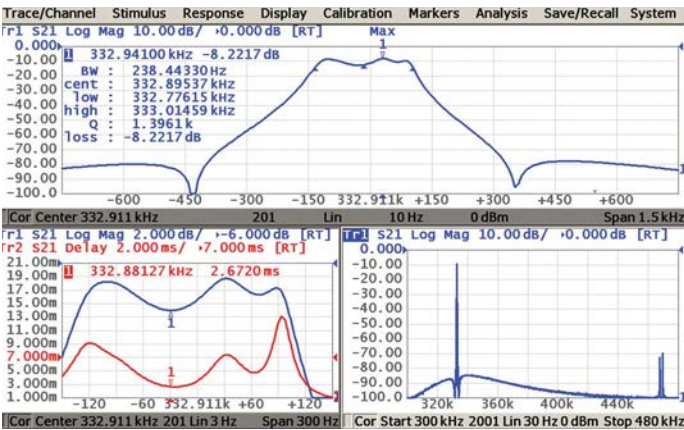
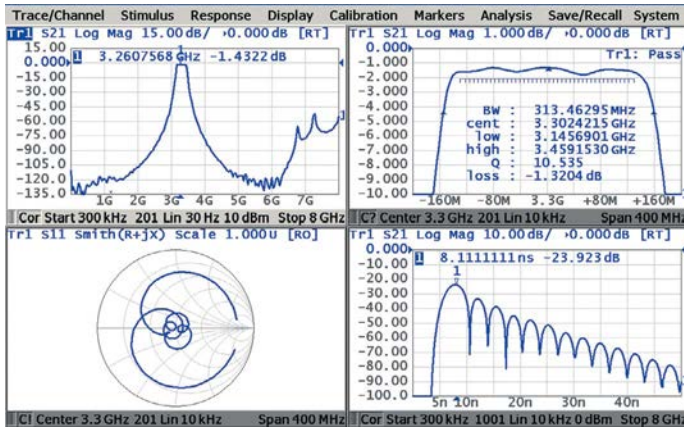

## Dynamic Range



### Measured parameters

$S_{11}$ ,  $S_{21}$ ,  $S_{12}$ ,  $S_{22}$  and absolute power of the reference and received signals at the port.

### Number of measurement channels

Up to 16 independent logical channels: each logical channel is represented on the screen as an individual channel window. A logical channel is defined by such stimulus signal settings as frequency range, number of test points, or power level.

### Data traces

Up to 16 data traces can be displayed in each channel window. A data trace represents one of such parameters of the DUT as S-parameters, response in time domain, input power response.

### Memory traces

Each of the 16 data traces can be saved into memory for further comparison with the current values.

### Data display formats

Logarithmic magnitude, linear magnitude, phase, expanded phase, group delay, SWR, real part, imaginary part, Smith chart diagram and polar diagram display formats are available.

Typical dynamic range of 150 dB is achieved through the entire frequency range (at 1 Hz IF bandwidth). Seen here is the maximum dynamic range achieved when using IFBW 1 Hz and an output power level of 10 dBm.

## Sweep Features

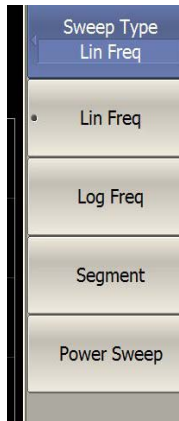

### Sweep type

Linear frequency sweep, logarithmic frequency sweep, and segment frequency sweep occur when the stimulus power is a fixed value. Linear power sweep occurs when frequency is a fixed value.

### Measured points per sweep

Set by the user from 2 to 500,001.

### Segment sweep features

A frequency sweep within several independent user-defined segments. Frequency range, number of sweep points, source power, and IF bandwidth should be set for each segment.

### Power

Source power from -60 dBm to +10 dBm with resolution of 0.05 dB. In frequency sweep mode, the power slope can be set to up to 2 dB/GHz for compensation of high frequency attenuation in connection wires.

### Sweep trigger

Trigger modes: continuous, single, or hold.  
 Trigger sources: internal, manual, external, bus

## Trace Functions

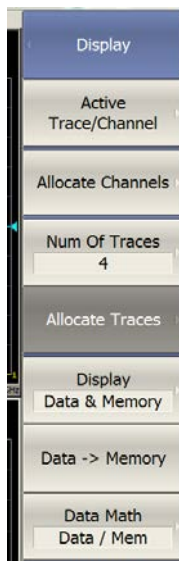

### Trace display

Data trace, memory trace, or simultaneous indication of data and memory traces.

### Trace math

Data trace modification by math operations: addition, subtraction, multiplication or division of measured complex values and memory data.

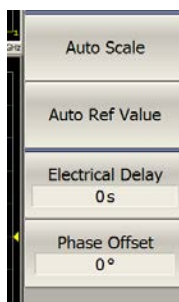

### Autoscaling

Automatic selection of scale division and reference level value allow the most effective display of the trace.

### Electrical delay

Calibration plane moving to compensate for the delay in the test setup. Compensation for electrical delay in a device under test (DUT) during measurements of deviation from linear phase.

### Phase offset

Phase offset is defined in degrees.

## Frequency Scan Segmentation

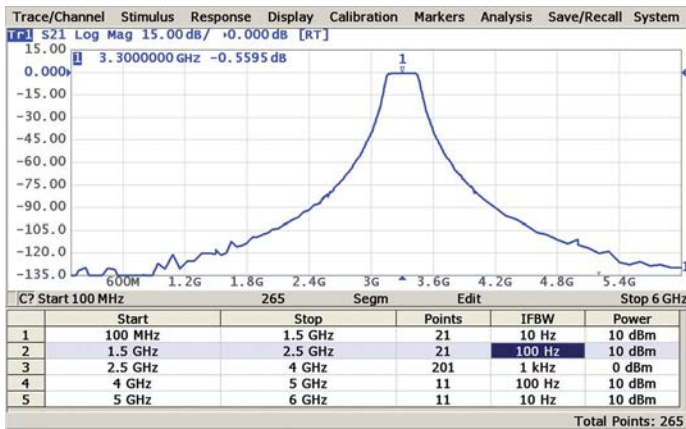

The VNA has a large frequency range with the option of frequency scan segmentation. This allows optimal use of the device, for example, to realize the maximum dynamic range while maintaining high measurement speed.

## Power Scanning and Compression Point Recognition



The power sweep feature turns compression point recognition, one of the most fundamental and complex amplifier measurements, into a simple and accurate operation.

## Adjustable Test Set

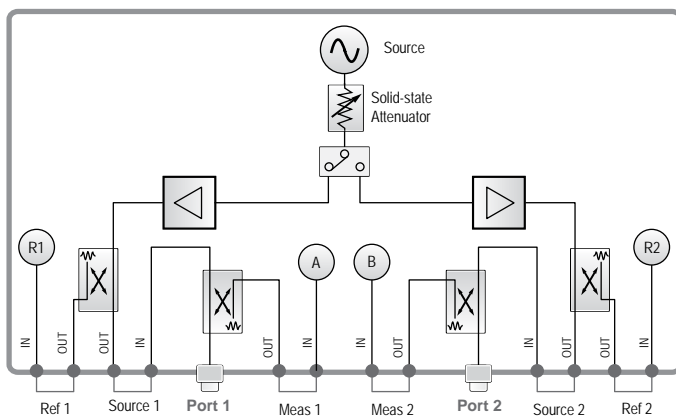

This adjustable port configuration with direct access to the receivers of the VNA provides for a variety of test applications requiring wider dynamic and power range.

## Mixer/Converter Measurements

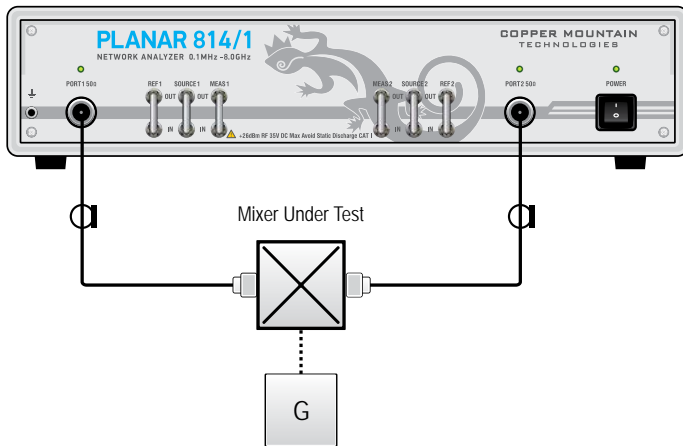

### Scalar mixer / converter measurements

The scalar method allows the user to measure only the magnitude of the transmission coefficient of the mixer and other frequency translating devices. No external mixers or other devices are required. The scalar method employs port frequency offset when there is a difference between the source port frequency and the receiver port frequency.

### Scalar mixer / converter calibration

This is the most accurate method of calibration applied for measurements of mixers in frequency offset mode. The OPEN, SHORT, and LOAD calibration standards are used. An external power meter should be connected to the USB port directly or via USB/GPIB adapter.

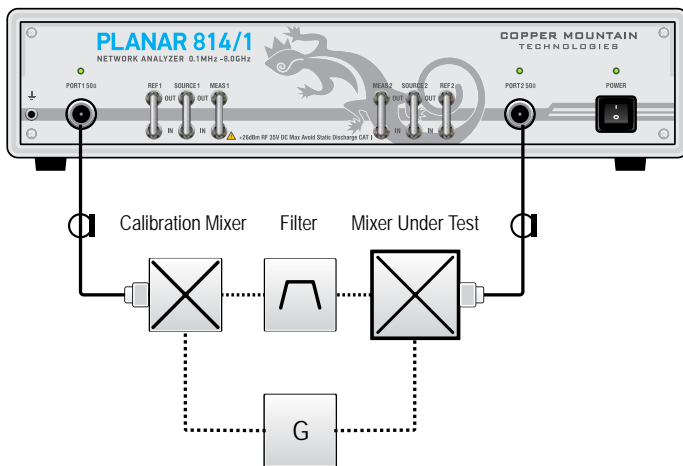

### Vector mixer / converter measurements

The vector method allows the measurement of both the magnitude and phase of the mixer transmission coefficient. This method requires an external mixer and an LO common for both the external mixer and the mixer under test.

### Vector mixer /converter calibration

This method of calibration is applied for vector mixer measurements. OPEN, SHORT and LOAD calibration standards are used.



### Automatic frequency offset adjustment

The function performs automatic frequency offset adjustment when the scalar mixer / converter measurements are performed to compensate for internal LO setting inaccuracy in the DUT.



## Time Domain Measurements

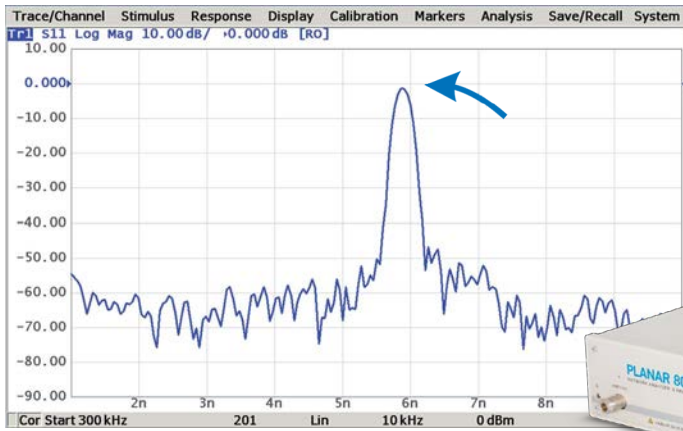

This function performs data transformation from frequency domain into response of the DUT to various stimulus types in time domain. Modeled stimulus types: bandpass, lowpass impulse, and lowpass step. Time domain span is set by the user arbitrarily from zero to maximum, which is determined by the frequency step. Windows of various forms are used for better tradeoff between resolution and level of spurious sidelobes.

Here, built-in time domain analysis allows the user to detect a physical impairment in the antenna feeder.

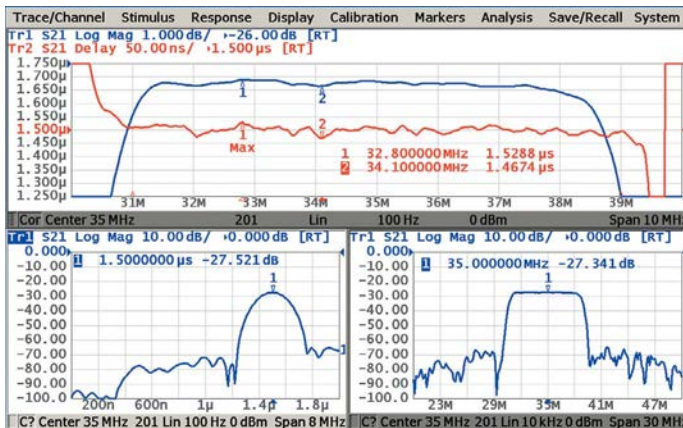
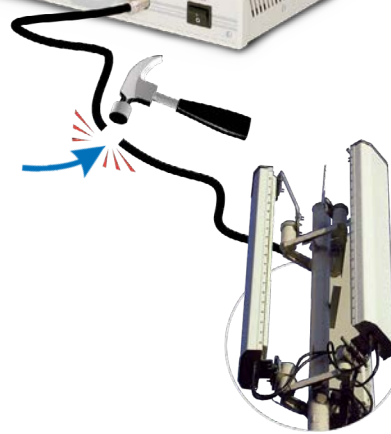

Time Domain analysis allows measurement of parameters of SAW filters such as the signal time delay, feedthrough signal suppression.

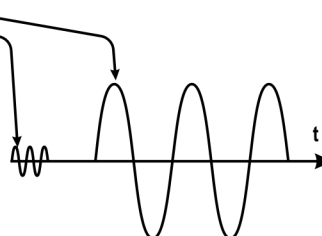
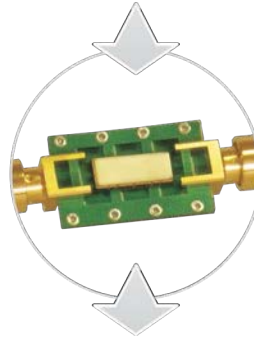
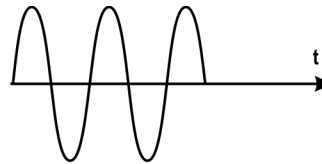

## Time Domain Gating

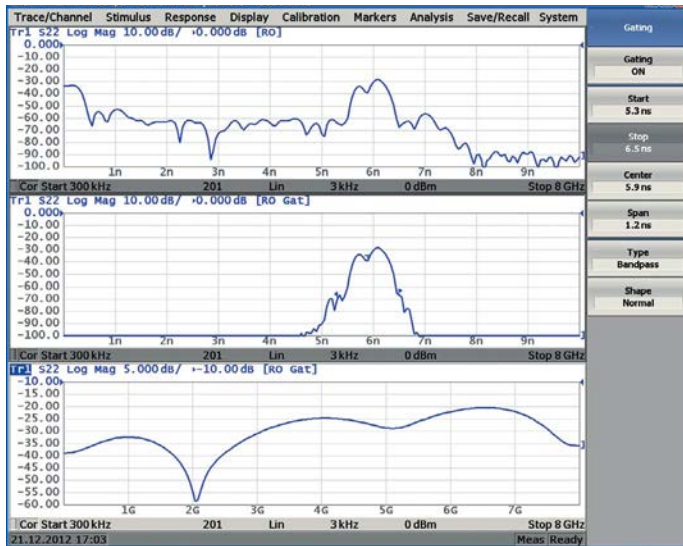

This function mathematically removes unwanted responses in the time domain, which allows the user to obtain frequency response without influence from fixture elements.

This function applies reverse transformation back to the frequency domain after cutting out the user-defined span in time domain. Gating filter types: bandpass or notch. For a better tradeoff between gate resolution and level of spurious sidelobes the following filter shapes are available: maximum, wide, normal and minimum.

Applications of these features include, but are not limited to: measurement of SAW filter parameters, such as filter time delay or forward transmission attenuation.

## Limit Testing

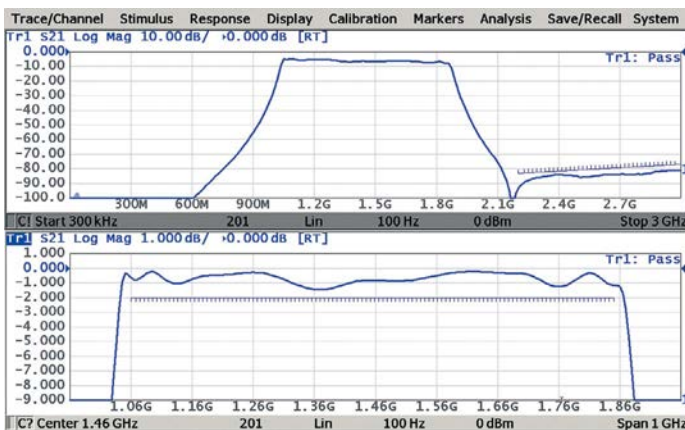

Limit testing is a function of automatic pass/fail judgment for the trace of the measurement results. The judgment is based on the comparison of the trace to the limit line set by the user and can consist of one or several segments.

Each segment checks the measurement value for failing either the upper or lower limit, or both. The limit line segment is defined by specifying the coordinates of the beginning (X0, Y0) and the end (X1, Y1) of the segment, and type of the limit. The MAX or MIN limit types check if the trace falls outside of the upper or lower limit, respectively.

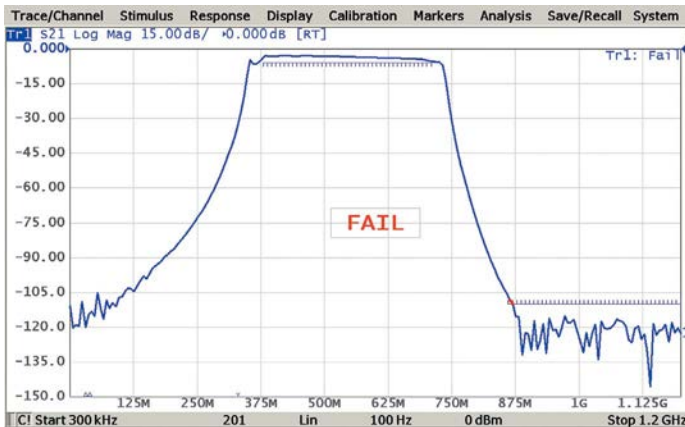

## Embedding

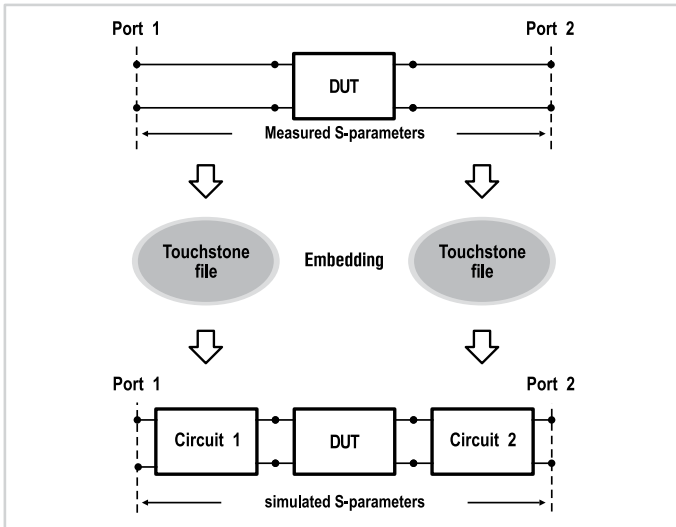

This function allows the user to mathematically simulate DUT parameters by virtually integrating a fixture circuit between the calibration plane and the DUT. This circuit should be described by an S-parameter matrix in a Touchstone file.

## De-Embedding

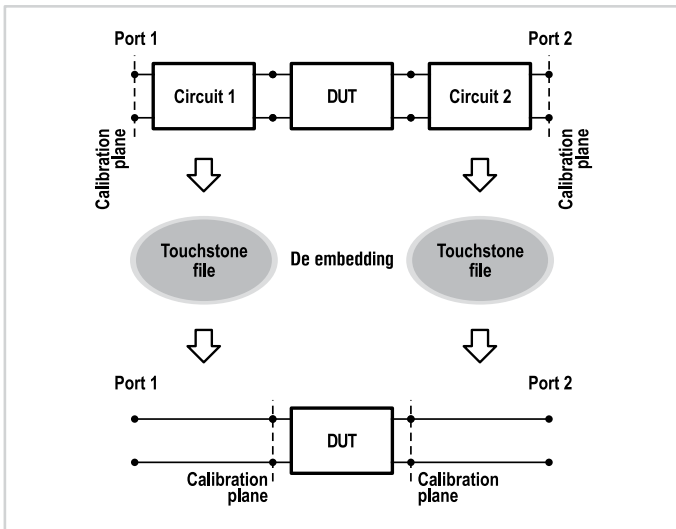

This function allows the user to mathematically exclude the effect of the fixture circuit connected between the calibration plane and the DUT from the measurement results. This circuit should be described by an S-parameter matrix in a Touchstone file.

## Port Impedance Conversion

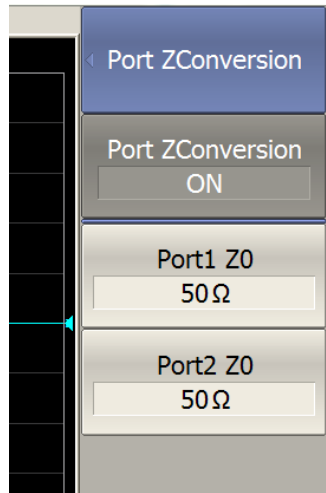

The function of conversion of the S-parameters measured at 50 Ω port into the values, which could be determined if measured at a test port with arbitrary impedance.

## S-Parameter Conversion

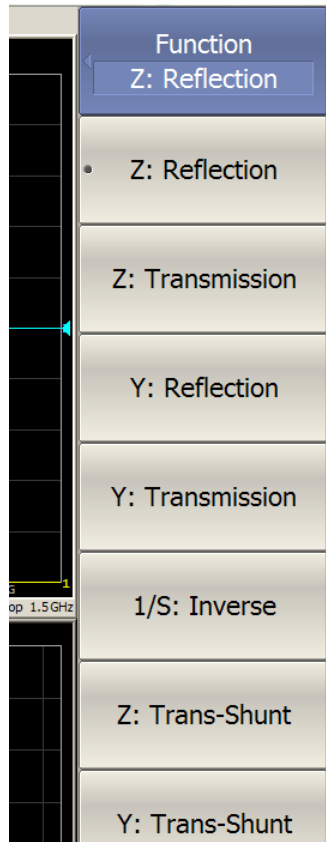

The function allows conversion of the measured S-parameters to the following parameters: reflection impedance and admittance, transmission impedance and admittance, and inverse S-parameters.

## Data Output

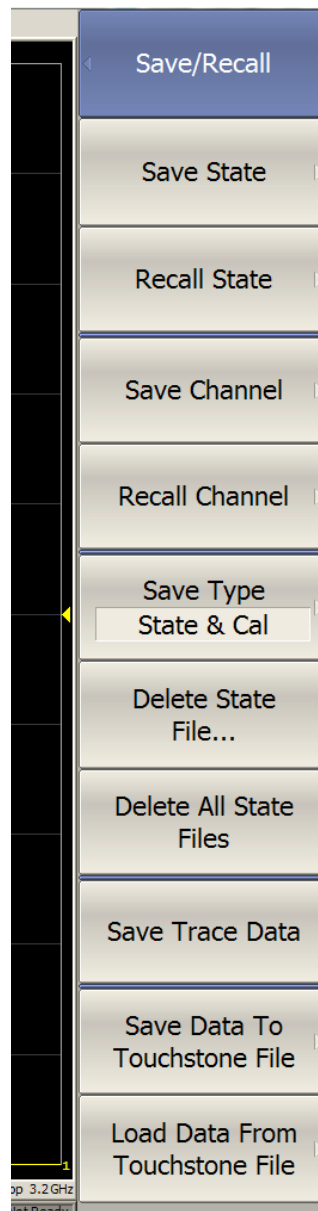

### Analyzer State

All state, calibration and measurement data can be saved to an Analyzer state file on the hard disk and later uploaded back into the software program. The following four types of saving are available: State, State & Cal, Stat & Trace, or All.

### Channel State

A channel state can be saved into the Analyzer memory. The channel state saving procedure is similar to saving of the Analyzer state saving, and the same saving types are applied to the channel state saving. Unlike the Analyzer state, the channel state is saved into the Analyzer inner volatile memory (not to the hard disk) and is cleared when the power to the Analyzer is turned off. For channel state storage, there are four memory registers A, B, C, D. The channel state saving allows the user to easily copy the settings of one channel to another one.

### Trace Data CSV File

The Analyzer allows the use to save an individual trace data as a CSV file (comma separated values). The active trace stimulus and response values in current format are saved to \*.CSV file. Only one trace data are saved to the file.

### Trace Data Touchstone File

The Analyzer allows the user to save S-parameters to a Touchstone file. The Touchstone file contains the frequency values and S-parameters. The files of this format are typical for most of circuit simulator programs.

The \*.s2p files are used for saving all the four S-parameters of a 2-port device.

The \*.s1p files are used for saving S11 and S22 parameters of a 1-port device.

Only one (active) trace data are saved to the file.

The Touchstone file saving function is applied to individual active channels.

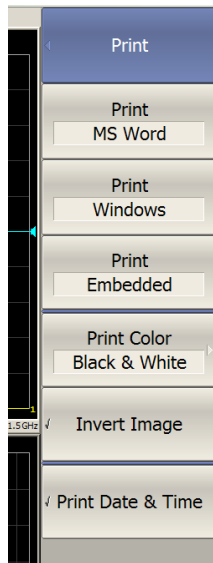

### Screenshot capture

The print function is provided with the preview feature, which allows the user to view the image to be printed on the screen, and/or save it to a file. Screenshots can be printed using three different applications: MS Word, Image Viewer for Windows, or the Print Wizard of the Analyzer. Each screenshot can be printed in color, grayscale, black and white, or inverted for visibility or ink use. The current date and time can be added to each capture before it is transferred to the printing application, resulting in quick and easy test reporting.

## Measurement Automation



### COM/DCOM compatible

Planar 814/1 software is COM/DCOM compatible, which allows the unit to be used as a part of an ATE station and other special applications. COM/DCOM automation is used for remote control and data exchange with the user software. The Analyzer program runs as COM/DCOM server. The user program runs as COM/DCOM client. The COM client runs on Analyzer PC. The DCOM client runs on a separate PC connected via LAN.

### LabView compatible

The device and its software are fully compatible with LabView applications, for ultimate flexibility in user-generated programming and automation.

## Accuracy Enhancement

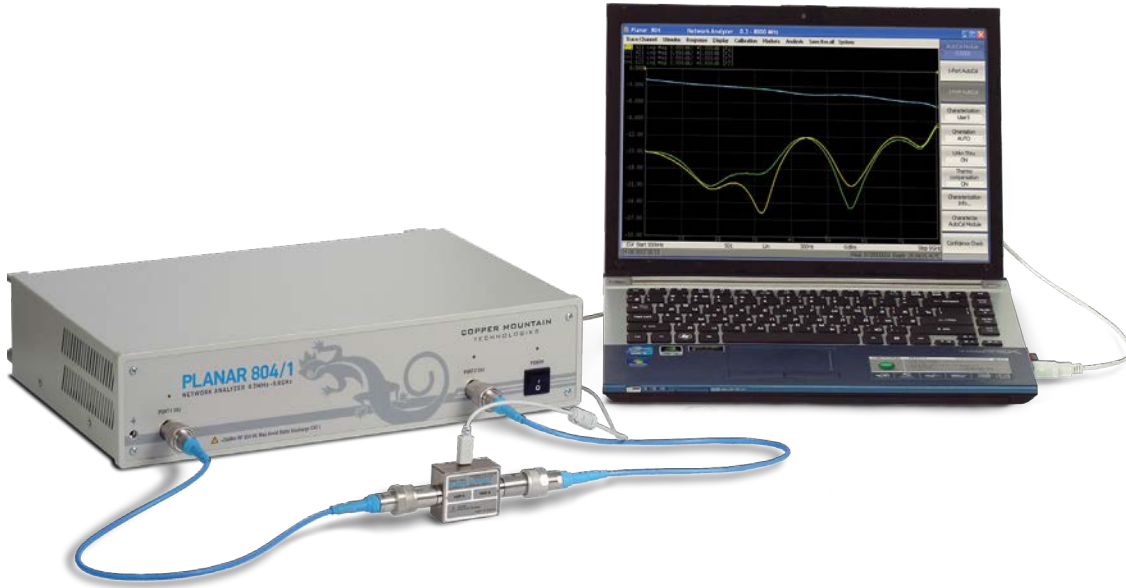

### Calibration

Calibration of a test setup (which includes the VNA, cables, and adapters) significantly increases the accuracy of measurements. Calibration allows for correction of the errors caused by imperfections in the measurement system: system directivity, source and load match, tracking and isolation.

### Calibration methods

The following calibration methods of various sophistication and accuracy enhancement level are available:

- ▶ reflection and transmission normalization
- ▶ full one-port calibration
- ▶ one-path two-port calibration
- ▶ full two-port calibration

### Reflection and transmission normalization

This is the simplest calibration method; however, it provides reasonably low accuracy compared to other methods.

### Full one-port calibration

Method of calibration performed for one-port reflection measurements. It ensures high accuracy.

### One-path two-port calibration

Method of calibration performed for reflection and one-way transmission measurements, for example for measuring  $S_{11}$  and  $S_{21}$  only. It ensures high accuracy for reflection measurements, and mean accuracy for transmission measurements.

### Full two-port calibration

This method of calibration is performed for full S-parameter matrix measurement of a two-port DUT, ensuring high accuracy.

### TRL calibration

Method of calibration performed for full S-parameter matrix measurement of a two-port DUT. It ensures higher accuracy than two-port calibration. LRL and LRM modifications of this calibration method are available.

### Mechanical Calibration Kits

The user can select one of the predefined calibration kits of various manufacturers or define own calibration kits.

### Electronic Calibration Modules

Electronic, or automatic, calibration modules offered by CMT make the analyzer calibration faster and easier than traditional mechanical calibration.

### Sliding load calibration standard

The use of sliding load calibration standard allows significant increase in calibration accuracy at high frequencies compared to the fixed load calibration standard.

### “Unknown” Thru calibration standard

The use of a generic two-port reciprocal circuit instead of a Thru in full two-port calibration allows the user to calibrate the VNA for measurement of "non-insertable" devices.

### Defining of calibration standards

Different methods of calibration standard defining are available:

- ▶ standard defining by polynomial model
- ▶ standard defining by data (S-parameters)

### Error correction interpolation

When the user changes any settings such as the start/stop frequencies and number of sweep points, compared to the settings at the moment of calibration, interpolation or extrapolation of the calibration coefficients will be applied.

## Supplemental Calibration Methods

### Power calibration

Power calibration allows more stable maintenance of the power level setting at the DUT input. An external power meter should be connected to the USB port directly or via USB/GPIB adapter.

### Receiver calibration

This method calibrates the receiver gain at the absolute signal power measurement.

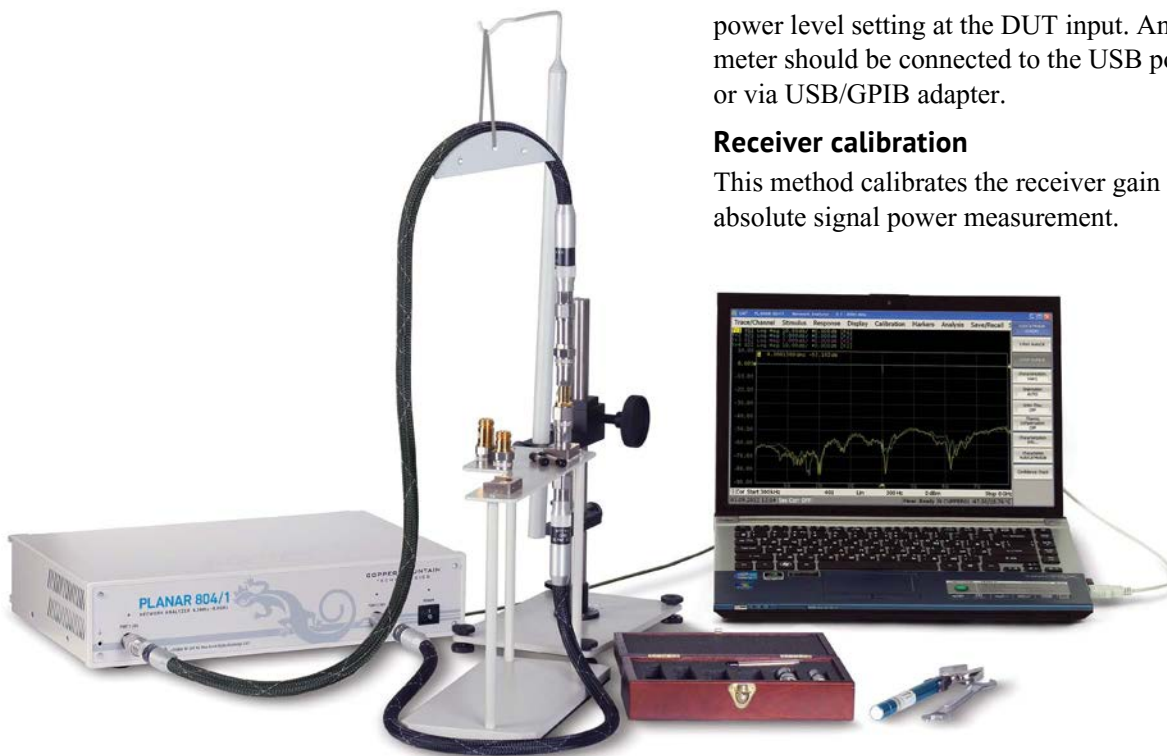



## TECHNICAL SPECIFICATIONS

### MEASUREMENT RANGE

Impedance	50 $\Omega$ (75 $\Omega$ connectors via adapters)
Test port connector	N-type, female
Number of test ports	2
Frequency range	100 kHz to 8.0 GHz
Full CW frequency accuracy	$\pm 5 \times 10^{-6}$
Frequency setting resolution	1 Hz
Number of measurement points	1 to 500,001
Measurement bandwidths	1 Hz to 30 kHz (with 1/1.5/2/3/5/7 steps)
Dynamic range (IF bandwidth 10 Hz)	From 100 kHz to 300 kHz: 115 dB, typ. 125 dB
	From 300 kHz to 8.0 GHz: 145 dB, typ. 150 dB

### MEASUREMENT ACCURACY

#### Accuracy of transmission measurements (magnitude / phase)<sup>1</sup>

+5 dB to +15 dB	0.2 dB / 2°
-50 dB to +5 dB	0.1 dB / 1°
-70 dB to -50 dB	From 100 kHz to 300 kHz: 1.5 dB / 10°
	From 300 kHz to 8.0 GHz: 0.2 dB / 2°
-90 dB to -70 dB	From 300 kHz to 8.0 GHz: 1.0 dB / 6°

#### Accuracy of reflection measurements (magnitude / phase)<sup>1</sup>

-15 dB to 0 dB	0.4 dB / 3°
-25 dB to -15 dB	1.0 dB / 6°
-35 dB to -25 dB	3.0 dB / 20°

#### Trace stability

Trace noise magnitude (IF bandwidth 3 kHz)	From 100 kHz to 300 kHz: 5 mdB rms
	From 300 kHz to 8.0 GHz: 1 mdB rms
Temperature dependence (per one degree of temperature variation)	0.02 dB

### EFFECTIVE SYSTEM DATA<sup>1</sup>

Effective directivity	46 dB
Effective source match	40 dB
Effective load match	46 dB

### TEST PORT

Directivity (without system error correction)	100 kHz to 300 kHz: 15 dB
	300 kHz to 8.0 GHz: 18 dB

<sup>1</sup> applies over the temperature range of 73°F  $\pm$  9 °F (23°C  $\pm$  5 °C) after 40 minutes of warming-up, with less than 1 °C deviation from the one-path two-port calibration temperature, at output power of -5 dBm, and 10 Hz IF bandwidth.

\*All technical specifications apply to all devices that have been factory calibrated in 2013 and after.

## TEST PORT OUTPUT

Match (without system error correction)	18 dB
Power range: 100 kHz to 6.0 GHz	-60 dBm to +10 dBm
Power range: 6.0 GHz to 8.0 GHz	-60 dBm to +5 dBm
Power accuracy	±1.5 dB
Power resolution	0.05 dB
Harmonics distortion	From 300 kHz to 8.0 GHz: -25 dBc
Non-harmonic spurious	From 300 kHz to 8.0 GHz: -30 dBc

## TEST PORT INPUT

Match (without system error correction)	18 dB
Damage level	+26 dBm
Damage DC voltage	35 V
Noise level (defined as the rms value of the specified noise floor, IF bandwidth 10 Hz)	From 100 kHz to 300 kHz: -105 dBm From 300 kHz to 8.0 GHz: -125 dBm

## MEASUREMENT SPEED

Measurement time per point	100 $\mu$ s
Source to receiver port switchover time	10 ms

### Typical cycle time versus number of measurement points

		Number of points			
		51	201	401	1601
Start 100 kHz, stop 10 MHz, IF bandwidth 30 kHz	Uncorrected	13.1 ms	51.3 ms	102.3 ms	408.3 ms
	Full two-port calibration	45.5 ms	122.0 ms	230.5 ms	840.5 ms
Start 10 MHz, stop 8.0 GHz, IF bandwidth 30 kHz	Uncorrected	6.5 ms	21.1 ms	40.5 ms	157.7 ms
	Full two-port calibration	32.4 ms	61.7 ms	100.3 ms	333.0 ms

## GENERAL DATA

### External reference frequency

External reference frequency	10 MHz
Input level	2 dBm $\pm$ 2 dB
Input impedance at «10 MHz» input	50 $\Omega$
Connector type	BNC female

### Output reference signal

Output reference signal level at 50 $\Omega$ impedance	3 dBm $\pm$ 2 dB
«OUT 10 MHz» connector type	BNC female

### **Atmospheric tolerances**

Operating temperature range	+41 °F to +104 °F (+5 °C to +40 °C)
Storage temperature range	-49 °F to +131 °F (-45 °C to +55 °C)
Humidity	90% at 77 °F (25 °C)
Atmospheric pressure	84 to 106.7 kPa

### **Calibration Frequency**

Calibration interval	3 years
----------------------	---------

### **External PC system requirements**

Operating system	Windows XP, Vista, 7, 8
CPU frequency	1 GHz
RAM	512 MB

### **Power supply**

Power supply	110-240 V, 50/60 Hz
Power consumption	40 W
Dimensions (L x W x H)	12.8 x 16.3 x 3.8 in (324 x 415 x 96 mm)
Weight	15.4 lbs (7 kg)

---

**Copper Mountain Technologies is changing the way VNAs are used in the industry. Our unique VNAs deliver highly accurate measurements at a fraction of the price of traditional instrumentation. Leveraging breakthrough advances in RF technology, CMT manages to compress an advanced feature set and high performance into a compact form factor. We specialize in making affordable high performance analyzers for many environments and applications, with a wide variety of solutions from 20 kHz to 14 GHz.**



For a complete listing of our global sales network,  
please visit [www.coppermountaintech.com](http://www.coppermountaintech.com)



**COPPER MOUNTAIN TECHNOLOGIES**

US Office: +1.317.222.5400 | Singapore Office: +65.63.23.6546

[coppermountaintech.com](http://coppermountaintech.com)