

# MICRO-CON-X<sup>®</sup>

0.53" [13MM] OD 2-7 CONTACTS



**CABLE END - SOCKET**  
MATES WITH PANEL MOUNT AND  
CABLE TO CABLE



**CABLE END - PIN**  
MATES WITH PANEL MOUNT AND  
CABLE TO CABLE



**CABLE TO CABLE / INLINE - SOCKET**  
MATES WITH CABLE END



**PANEL MOUNT - PIN**  
MATES WITH CABLE END



**PANEL MOUNT - SOCKET**  
MATES WITH CABLE END



**DUST CAP**  
P/N - 16295



**IP RATED LOCKING CAP**  
P/N-16295P (2-3 Contacts)



**MOLDED CABLE END ASSEMBLY**



**MOLDED CABLE TO CABLE ASSEMBLY**



**MOLDED RIGHT ANGLE CABLE ASSEMBLY**

## **SPECIFICATIONS**

### **Mechanical Specifications**

Life:	300 insertion / withdrawal cycles minimum
Vibration:	Coupling rings have overriding locking feature to prevent loosening or separation of connector
Hex Nut Torque:	9 in-lb max tightening torque.
Coupling Locking Style:	Bayonet with ribbed coupling nut (winged coupling nut available) P/N 16482
Backshell Style:	Non-removable snap lock
Conductor Sizes:	#20 accepts 20 through 24 AWG #22 contacts accepts 22 through 24 AWG #26 contacts accepts 24 through 26 AWG

### **Electrical Specifications**

Voltage Rating:	600V AC/DC
Current Rating:	7.5 A – max (See page 107 for Electrical Current Rating Chart)

### **Environmental Specifications**

Operating Temperature Rating:	-40°C to +85°C (-40°F to +185°F)
Salt Atmosphere (Corrosion):	300 Hr salt spray when mated
Weathertight:	IP67 at the face, when mated

### **Material Specifications**

Backshell:	Thermoplastic, UL 94HB, Black
Contacts:	Copper Alloy, Gold over Nickel Plate
Coupling Ring:	Thermoplastic, UL 94HB, Black
Gasket:	Elastomer, Black
Grommet / Strain Relief:	Elastomer, Black
Hex Nut:	Thermoplastic, UL 94HB, Black
O-Ring:	Elastomer, Black
Shell:	Thermoplastic, UL 94HB, Black
Optional Dust Cap:	Elastomer, Black

### **Molded Cable Assemblies**

Weathertight:	NEMA 6P, 13: IEC IP67
---------------	-----------------------

### **Certifications**

UL File E150822  
CSA File 181200  
Not for current interruption  
RoHS compliant  
REACH compliant

### **Options**

UV Rating:	F1 available
Flame Rating:	UL 94-HB; UL 94V-0 available

**Consult factory for optional colors and materials**

## FIELD INSTALLABLE KITS

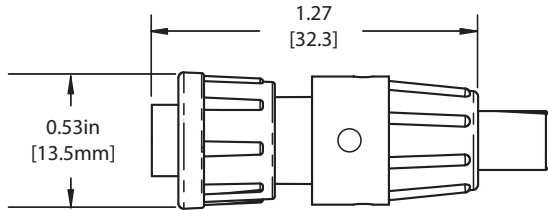

**16XXX-XXG-3XX**  
FIELD INSTALLABLE  
CABLE CONNECTOR  
BACKSHELL TYPE 3-SHORT  
\*2 & 3 POSITION ONLY\*

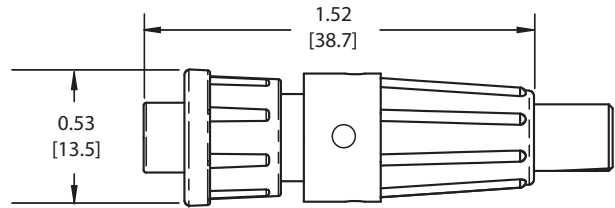

**16XXX-XXG-5XX**  
FIELD INSTALLABLE  
CABLE CONNECTOR  
BACKSHELL TYPE 5-LONG

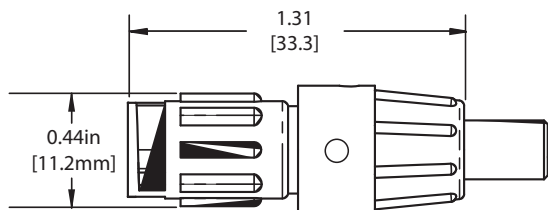

**18XXX-XXG-3XX**  
FIELD INSTALLABLE  
CABLE TO CABLE CONNECTOR  
BACKSHELL TYPE 3-SHORT  
\*2 & 3 POSITION ONLY\*

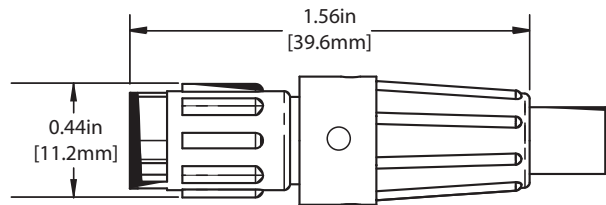

**18XXX-XXG-5XX**  
FIELD INSTALLABLE  
CABLE TO CABLE CONNECTOR  
BACKSHELL TYPE 5-LONG

## PANEL MOUNT ASSEMBLY KITS

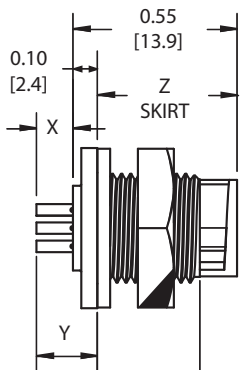

**17X80-XXG-3XX**  
PANEL MOUNT CONNECTOR  
CRIMP

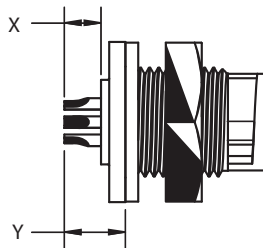

**17X82-XXG-3XX**  
PANEL MOUNT CONNECTOR  
SOLDER CUP

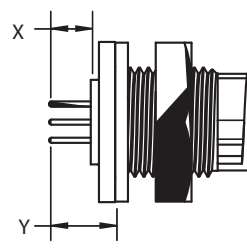

**17X8X-XXG-3XX**  
PANEL MOUNT CONNECTOR  
PC TAIL

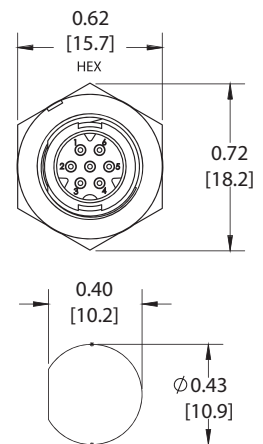

**RECOMMENDED  
PANEL CUT-OUT**  
TOLERANCE: ±.003

\*X, Y, Z - Consult Factory. All dimensions are for reference only. Units shown: in[mm].

## PANEL MOUNT / CABLE TO CABLE CONNECTORS

Front View | Wire View

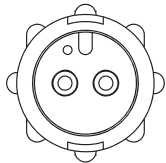

2 POSITION  
#20 PIN & SOCKET  
CONTACT

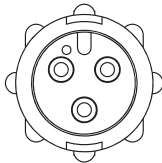

3 POSITION  
#20 PIN & SOCKET  
CONTACT

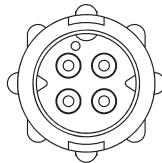

4 POSITION  
#22 PIN & SOCKET  
CONTACT

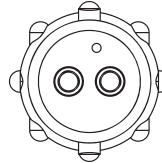

2 POSITION  
#20 PIN & SOCKET  
CONTACT

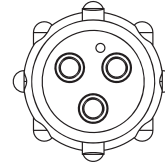

3 POSITION  
#20 PIN & SOCKET  
CONTACT

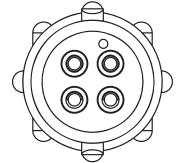

4 POSITION  
#22 PIN & SOCKET  
CONTACT

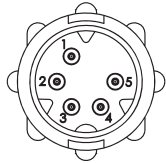

5 POSITION B-KEY  
#26 PIN & SOCKET  
CONTACT

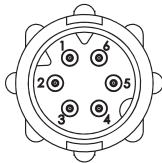

6 POSITION A-KEY  
#26 PIN & SOCKET  
CONTACT

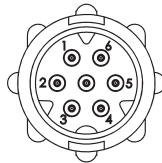

7 POSITION B-KEY  
#26 PIN & SOCKET  
CONTACT

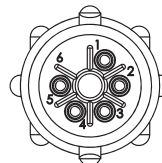

5 POSITION B-KEY  
#26 PIN & SOCKET  
CONTACT

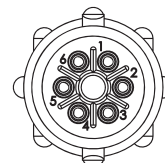

6 POSITION A-KEY  
#26 PIN & SOCKET  
CONTACT

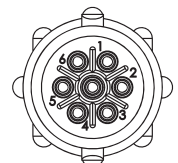

7 POSITION B-KEY  
#26 PIN & SOCKET  
CONTACT

## CABLE CONNECTORS

Front View | Wire View

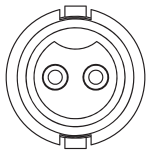

2 POSITION  
#20 PIN & SOCKET  
CONTACT

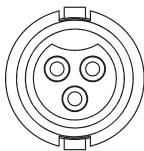

3 POSITION  
#20 PIN & SOCKET  
CONTACT

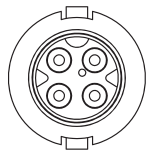

4 POSITION  
#22 PIN & SOCKET  
CONTACT

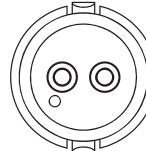

2 POSITION  
#20 PIN & SOCKET  
CONTACT

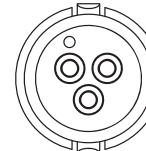

3 POSITION  
#20 PIN & SOCKET  
CONTACT

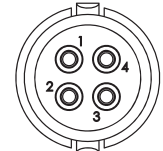

4 POSITION  
#22 PIN & SOCKET  
CONTACT

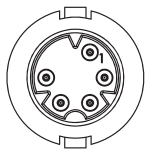

5 POSITION B-KEY  
#26 PIN & SOCKET  
CONTACT

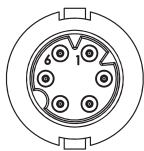

6 POSITION A-KEY  
#26 PIN & SOCKET  
CONTACT

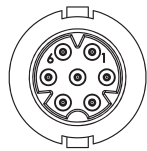

7 POSITION B-KEY  
#26 PIN & SOCKET  
CONTACT



5 POSITION B-KEY  
#26 PIN & SOCKET  
CONTACT

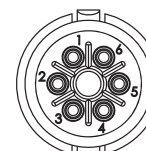

6 POSITION A-KEY  
#26 PIN & SOCKET  
CONTACT

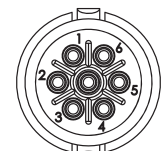

7 POSITION B-KEY  
#26 PIN & SOCKET  
CONTACT

All dimensions are for reference only. Units shown: in[mm].

## CUSTOM MOLDED CABLE ASSEMBLIES

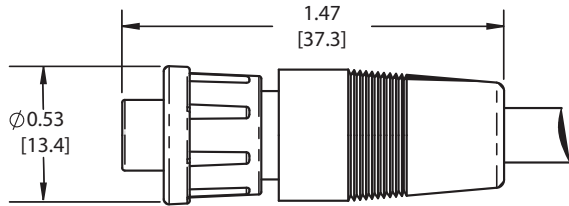

**16XXX-XXG**  
CABLE CONNECTOR  
STRAIGHT OVERMOLDED

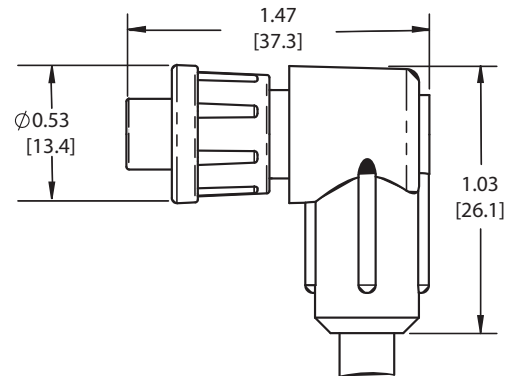

**16XXX-XXG**  
CABLE CONNECTOR  
RIGHT ANGLE OVERMOLDED

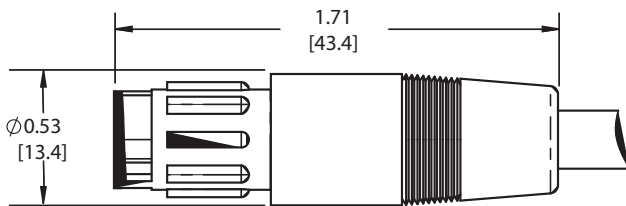

**18XXX-XXG**  
CABLE TO CABLE CONNECTOR  
STRAIGHT OVERMOLDED

All dimensions are for reference only. Units shown: in[mm].

## PART NUMBER TO ORDER

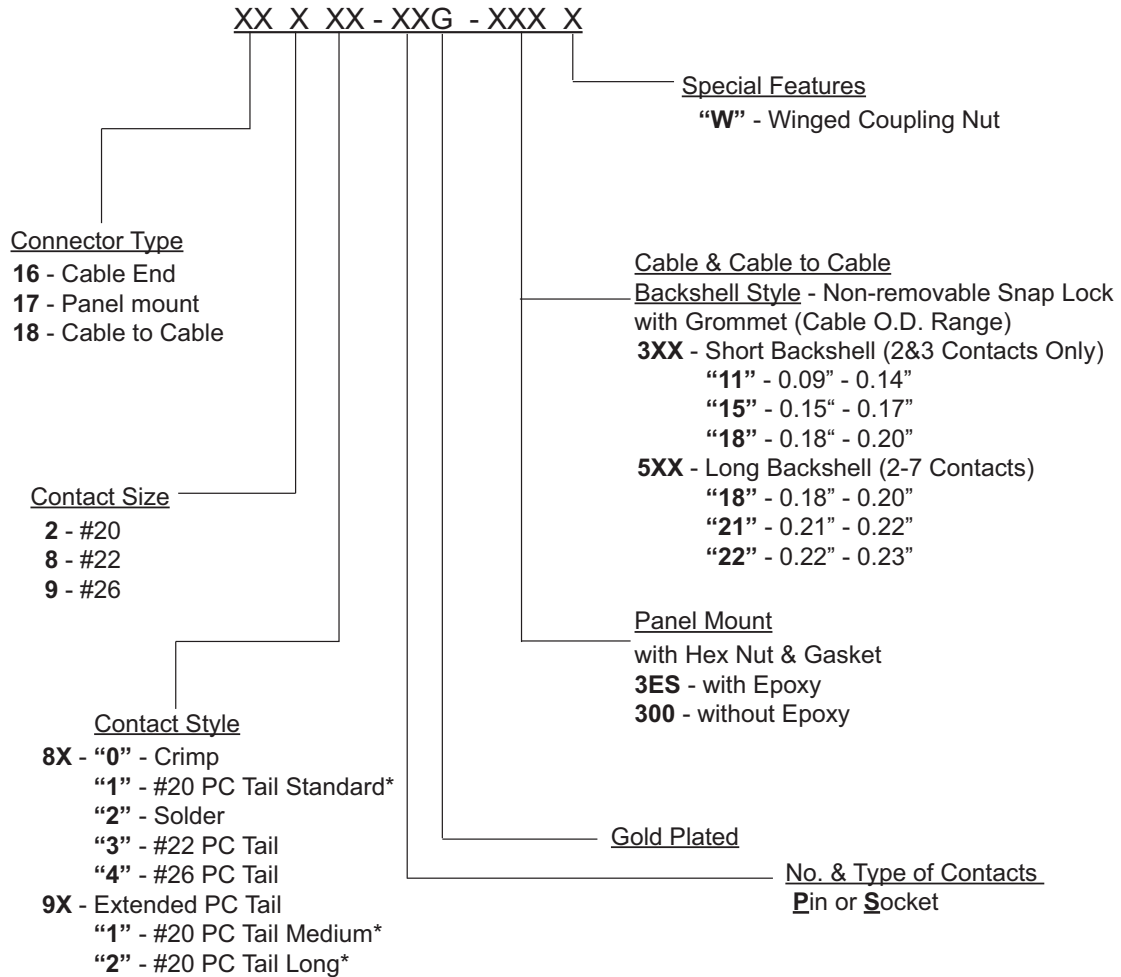

\*Consult factory for length and diameter of PC Tail. Additionally, alternative colors and materials are available.